

## Grandstream Networks, Inc.

GXV3450/GXV3470/GXV3480

**User Guide**



# GXV34x0 - User Guide

Thank you for purchasing Grandstream GXV34x0 IP Multimedia Phone for Android™. The GXV34x0 IP Video Phone for Android combines a 16-line IP video phone with a multi-platform video conferencing solution and the functionality of an Android tablet to offer an all-in-one communications solution. All the models come with HD resolution capacitive touch screen with different sizes, GXV3450 has 5" 1280×720 while GXV3470 and GXV3480 come 1280×800 and they support 7" and 8" respectively, tiltable camera with privacy shutter that supports 1080p 30fps HD video, dual Gigabit ports with PoE/PoE+, HD audio, integrated Wi-Fi (Dual band 802.11a/b/g/n/ac) for GXV3450 and Wi-Fi 6 (Dual band 802.11a/b/g/n/ac/ax) for GXV3470 and GXV3480 & Bluetooth 5, rich peripheral interfaces, and Android 11 By combining a state-of-the-art IP video phone, an advanced video conferencing solution, and the functionality of a tablet, businesses throughout the world can now use the GXV34x0 for all communication and productivity needs.

## PRODUCT OVERVIEW

### Feature Highlights

The following tables contain the major features of the GXV34x0:

 <p><b>GXV3480</b></p>	<ul style="list-style-type: none"> <li>• 16 lines with up to 16 SIP accounts, up to 12-way audio conference and 3-way 1080p 30fps HD video conference, phonebook with up to 2000 contacts, call history with up to 2000 records.</li> <li>• Dual switched 10/100/1000Mbps network ports, Dual-band 2.4GHz &amp; 5GHz Wi-Fi 6 (802.11a/b/g/n/ac/ax), PoE/PoE+, Bluetooth, USB 3.0 and type-C ports, HDMI In and Out, RJ9 headset jack.</li> <li>• 8" (1280x800) capacitive (10 points) touch screen IPS LCD, Tilttable camera with privacy shutter, 1080P@30fps.</li> <li>• HD wideband audio, full-duplex hands-free speakerphone with HD acoustic chamber, advanced acoustic echo cancellation and excellent double-talk performance</li> <li>• Runs on Android 11 operating system.</li> </ul>
 <p><b>GXV3470</b></p>	<ul style="list-style-type: none"> <li>• 16 lines with up to 16 SIP accounts, up to 10-way audio conference and 3-way 720p 30fps HD video conference, phonebook with up to 1000 contacts, call history with up to 1000 records.</li> <li>• Dual switched 10/100/1000Mbps network ports, Dual-band 2.4GHz &amp; 5GHz Wi-Fi (802.11a/b/g/n/ac/ax), PoE/PoE+, Bluetooth, 2 USB ports, HDMI Out, RJ9 headset jack.</li> <li>• 7" (1280x800) capacitive (5 points) touch screen HD IPS LCD, Tilttable camera with privacy shutter, 1080P@30fps.</li> <li>• HD wideband audio, full-duplex hands-free speakerphone with HD acoustic chamber, advanced acoustic echo cancellation and excellent double-talk performance.</li> <li>• Runs on Android 11 operating system.</li> </ul>
 <p><b>GXV3450</b></p>	<ul style="list-style-type: none"> <li>• 16 lines with up to 16 SIP accounts, up to 10-way audio conference and 3-way 720p 30fps HD video conference, phonebook with up to 1000 contacts, call history with up to 1000 records.</li> <li>• Dual switched 10/100/1000Mbps network ports, Dual-band 2.4GHz &amp; 5GHz Wi-Fi (802.11a/b/g/n/ac), PoE/PoE+, Bluetooth, USB3.0 and USB2.0 ports, RJ9 headset jack.</li> <li>• 5" (1280x720) capacitive (5 points) touch screen HD IPS LCD, Tilttable camera with privacy shutter, 1080P@30fps.</li> </ul>

- HD wideband audio, full-duplex hands-free speakerphone with HD acoustic chamber, advanced acoustic echo cancellation and excellent double-talk performance.
- Runs on Android 11 operating system.

### GXV34x0 Features in a Glance

## Technical Specifications

The following tables resume all the technical specifications including the protocols / standards supported, voice codecs, telephony features, languages and upgrade/provisioning settings for the GXV34x0 series.

### o GXV3480 Technical Specifications

<b>Protocols/Standards</b>	SIP RFC3261, TCP/IP/UDP, RTP/RTCP, HTTP/HTTPS, ARP, ICMP, DNS (A record, SRV, NAPTR), DHCP, PPPoE, SSH, TFTP, NTP, STUN, SIMPLE, LLDP-MED, LDAP, TR-069, 802.1x, TLS, SRTP, IPv6, OpenVPN®
<b>Network Interfaces</b>	Dual switched 10/100/1000 Mbps ports with integrated PoE/PoE+
<b>Graphic Display</b>	8" 1280×800 capacitive touch screen (10 points) IPS LCD
<b>Camera</b>	Tiltable 2 megapixel CMOS camera with privacy shutter, 1080p 30fps
<b>Bluetooth</b>	Yes, integrated Bluetooth
<b>Wi-Fi</b>	Yes, dual-band (2.4GHz & 5GHz) with 802.11 a/b/g/n/ac/ax, 2T2R, Wi-Fi Display & AirPlay
<b>Auxiliary Ports</b>	RJ9 headset jack (allowing EHS with Plantronics headsets), 3.5mm stereo headset with microphone, USB 3.0 port, Type-C, HDMI-out, HDMI-in
<b>Feature Keys</b>	2 function touch keys VOLUME +/-, 3 dedicated Android touch keys HOME, MENU, and BACK
<b>Voice Codec</b>	Wide-band Opus, wide-band G.722, G.711μ/a, G.729A/B, G.726-32, iLBC, in-band and out-of-band DTMF (In audio, RFC2833, SIP INFO), VAD, CNG, AEC, PLC, AJB, AGC, ANS, Noise Shield 2.0
<b>Video Codec and Capabilities</b>	H.264 BP/MP/HP, video resolution up to 1080p, frame rate up to 30 fps, bit rate up to 4Mbps, 3-way video conference (1080p@30fps), BFCP, people video(up to 1080p@30fps) + content video(up to 1080p@15fps), anti-flickering and auto exposure
<b>Telephony Features</b>	Hold, transfer, forward (unconditional/no-answer/busy), call park/pickup, 12-way audio conference(including the host), shared-call-appearance (SCA) / bridged-line-appearance (BLA), virtual MPK, downloadable contacts (XML, LDAP, up to 2000 items), call record(local and server), call log (up to 2000 records), call waiting, auto answer, XML customization of screen, flexible dial plan, personalized music ringtones and music on hold, server redundancy & fail-over
<b>Sample Applications</b>	<ul style="list-style-type: none"> <li>● <b>Local apps:</b> Contacts, Call History, File Manager, Programmable Key, Settings, Browser, Clock, Voicemail, Calculator, Recorder, GS Market, etc.</li> <li>● Support third-party Android apps.</li> <li>● API/SDK available for advanced custom application development</li> </ul>
<b>Android</b>	Runs Android 11

<b>Applications Deployment</b>	Supports Android 11 compliant applications to be developed, downloaded and run on the device with provisioning control.
<b>HD Audio</b>	Yes, 2 omnidirectional microphones, HD handset and speakerphone with support for wideband audio
<b>Base Stand</b>	Integrated stand with multiple adjustable angles
<b>QoS</b>	Layer 2 QoS (802.1Q, 802.1p) and Layer 3 (ToS, DiffServ, MPLS) QoS
<b>Security</b>	User and administrator level passwords, random default admin password, MD5 and MD5-sess based authentication, 256-bit AES encrypted configuration file, TLS, SRTP, HTTPS, 802.1x media access control, Kensington Security Slot (Kensington Lock) support, anti-hacking secure boot
<b>Multi-language</b>	English, German, Italian, French, Spanish, Portuguese, Russian, Croatian, Chinese, Korean, Japanese, and more
<b>Upgrade/Provisioning</b>	Firmware upgrade via TFTP / HTTP / HTTPS or local HTTP upload, mass provisioning using TR-069 or AES encrypted XML configuration file, GDMS. <b>Note:</b> Users can remotely access the GXV3480's web interface through the GDMS device options menu.
<b>Power &amp; Green Energy Efficiency</b>	Universal power adapter included: Input: 100-240VAC 50-60Hz; Output 12VDC 1.5A (18W) Integrated PoE* 802.3af Class 3, PoE+ 802.3at, Class 4 <i>*Must use PSU or PoE+ to power up the phone when using USB devices</i>
<b>Temperature and Humidity</b>	<b>Operation:</b> 0°C to 40°C <b>Storage:</b> -10°C to 60°C <b>Humidity:</b> 10% to 90% Non-condensing
<b>Package Content</b>	GXV3480 phone, handset with cord, base stand, universal power supply, network cable, screen cleaning cloth, quick installation guide
<b>Compliance</b>	<b>FCC:</b> CFR 47 Part 15 Subpart B Class B; CFR 47 Part 15 Subpart C; CFR 47 Part 15 Subpart E; Part 68 (HAC) <b>IC:</b> RSS-247, RSS-GEN, RSS-102, ICES-003, CS-03. <b>CE:</b> EN 55032 Class B; EN 55035; EN IEC 61000-3-2; EN 61000-3-3; EN IEC 62368-1; ETSI EN 300328; ETSI EN 301893; ETSI EN 301489-1; ETSI EN 301489-17; EN IEC 62311 <b>UKCA:</b> BS EN 55032 Class B; BS EN 55035; BS EN IEC 61000-3-2; BS EN 61000-3-3; BS EN IEC 62368-1; ETSI EN 300328; ETSI EN 301893; ETSI EN 301489-1; ETSI EN 301489-17; BS EN IEC 62311 <b>RCM:</b> AS/ACIF S040 AS/CA S004; AS/NZS CISPR 32; AS/NZS 62368.1; AS/NZS 4268. HDMI RoHS 2.0

*GXV3480 Technical Specifications*

o **GXV3470 Technical Specifications**

<b>Protocols/Standards</b>	SIP RFC3261, TCP/IP/UDP, RTP/RTCP, HTTP/HTTPS, ARP, ICMP, DNS (A record, SRV, NAPTR), DHCP, PPPoE, SSH, TFTP, NTP, STUN, SIMPLE, LLDP-MED, LDAP, TR-069, 802.1x, TLS, SRTP, IPv6, OpenVPN®
<b>Network Interfaces</b>	Dual switched 10/100/1000 Mbps ports with integrated PoE/PoE+



<b>Graphic Display</b>	7" 1280×800 capacitive touch screen (5 points) HD IPS LCD
<b>Camera</b>	Tiltable 2 megapixel CMOS camera with privacy shutter, 1080p 30fps
<b>Bluetooth</b>	Yes, integrated Bluetooth
<b>Wi-Fi</b>	Yes, dual-band (2.4GHz & 5GHz) with 802.11 a/b/g/n/ac/ax, 2T2R, Wi-Fi Display & AirPlay
<b>Auxiliary Ports</b>	RJ9 headset jack (allowing EHS with Plantronics headsets), 3.5mm headset port, USB 2.0 port, USB 3.0 port, HDMI-out
<b>Feature Keys</b>	2 function touch keys VOLUME +/-, 3 dedicated Android touch keys HOME, MENU, and BACK
<b>Voice Codec</b>	Wide-band Opus, wide-band G.722, G.711μ/a, G.729A/B, G.726-32, iLBC, in-band and out-ofband DTMF (In audio, RFC2833, SIP INFO), VAD, CNG, AEC, PLC, AJB, AGC, ANS, Noise Shield 2.0
<b>Video Codec and Capabilities</b>	H.264 BP/MP/HP, video resolution up to 720p, frame rate up to 30 fps, bit rate up to 2Mbps, 3-way video conference (720p@30fps), anti-flickering and auto exposure
<b>Telephony Features</b>	Hold, transfer, forward (unconditional/no-answer/busy), call park/pickup, 10-way audio conference(including the host), shared-call-appearance (SCA) / bridged-line-appearance (BLA), virtual Programmable Key, downloadable contacts (XML, LDAP, up to 1000 items), call record(local and server), call log (up to 1000 records), call waiting, auto answer, XML customization of screen, flexible dial plan, personalized music ringtones and music on hold, server redundancy & fail-over
<b>Sample Applications</b>	<ul style="list-style-type: none"> <li>● <b>Local apps:</b> Contacts, Call History, File Manager, Programmable Key, Settings, Browser, Clock, Voicemail, Calculator, Recorder, GS Market, etc.</li> <li>● Support third-party Android apps.</li> <li>● API/SDK available for advanced custom application development</li> </ul>
<b>Android</b>	Runs Android 11
<b>Applications Deployment</b>	Supports Android 11 compliant applications to be developed, downloaded and run on the device with provisioning control.
<b>HD Audio</b>	Yes, 2 omnidirectional microphones, HD handset and speakerphone with support for wideband audio
<b>Base Stand</b>	Yes, built-in stand with multiple adjustable angles
<b>QoS</b>	Layer 2 QoS (802.1Q, 802.1p) and Layer 3 (ToS, DiffServ, MPLS) QoS
<b>Security</b>	User and administrator level passwords, random default admin password, MD5 and MD5-sess based authentication, 256-bit AES encrypted configuration file, TLS, SRTP, HTTPS, 802.1x media access control, Kensington Security Slot (Kensington Lock) support, anti-hacking secure boot
<b>Multi-language</b>	English, German, Italian, French, Spanish, Portuguese, Russian, Croatian, Chinese, Korean, Japanese, and more
<b>Upgrade/Provisioning</b>	Firmware upgrade via TFTP / HTTP / HTTPS or local HTTP upload, mass provisioning using TR-069 or AES encrypted XML configuration file, GDMS.

	<b>Note:</b> Users can remotely access the GXV3470's web interface through the GDMS device options menu.
<b>Power &amp; Green Energy Efficiency</b>	Universal power adapter included: Input: 100-240VAC 50-60Hz; Output 12VDC 1.5A (18W) Integrated PoE* 802.3af Class 3, PoE+ 802.3at, Class 4 <i>*Must use PSU or PoE+ to power up the phone when using USB devices</i>
<b>Temperature and Humidity</b>	<b>Operation:</b> 0°C to 40°C <b>Storage:</b> -10°C to 60°C <b>Humidity:</b> 10% to 90% Non-condensing
<b>Package Content</b>	GXV3470 phone, handset with cord, base stand, universal power supply, network cable, screen cleaning cloth, quick installation guide
<b>Compliance</b>	<b>FCC:</b> CFR 47 Part 15 Subpart B Class B; CFR 47 Part 15 Subpart C; CFR 47 Part 15 Subpart E; Part 68 (HAC) <b>IC:</b> RSS-247, RSS-GEN, RSS-102, ICES-003, CS-03 <b>CE:</b> EN 55032 Class B;EN 55035; EN IEC 61000-3-2; EN 61000-3-3; EN IEC 62368-1; ETSI EN 300328; ETSI EN 301893; ETSI EN 301489-1; ETSI EN 301489-17; EN IEC 62311 <b>UKCA:</b> BS EN 55032 Class B; BS EN 55035; BS EN IEC 61000-3-2; BS EN 61000-3-3; BS EN IEC 62368-1; ETSI EN 300328; ETSI EN 301893; ETSI EN 301489-1; ETSI EN 301489-17; BS EN IEC 62311 <b>RCM:</b> AS/ACIF S040 AS/CA S004; AS/NZS CISPR 32; AS/NZS 62368.1; AS/NZS 4268 HDMI , RoHS 2.0

*GXV3470 Technical Specifications*

o **GXV3450 Technical Specifications**

<b>Protocols/Standards</b>	SIP RFC3261, TCP/IP/UDP, RTP/RTCP, HTTP/HTTPS, ARP, ICMP, DNS (A record, SRV, NAPTR), DHCP, PPPoE, SSH, TFTP, NTP, STUN, LLDP-MED, LDAP, TR-069, 802.1x, TLS, SRTP, IPv6, OpenVPN®
<b>Network Interfaces</b>	Dual switched 10/100/1000 Mbps ports with integrated PoE/PoE+
<b>Graphic Display</b>	5.0 inch 1280×720 capacitive touch screen (5 points) HD IPS LCD
<b>Camera</b>	Tiltable 2 megapixel CMOS camera with privacy shutter, 1080p 30fps
<b>Bluetooth</b>	Yes, integrated Bluetooth
<b>Wi-Fi</b>	Yes, dual-band dual-stream Wi-Fi 5(2.4GHz & 5GHz) with 802.11 a/b/g/n/ac
<b>Auxiliary Ports</b>	RJ9 headset jack (allowing EHS with Plantronics headsets), USB 2.0 port, USB 3.0 port
<b>Feature Keys</b>	11 functions keys for CONFERENCE, TRANSFER, SEND/REDIAL, MUTE, EARPHONE, SPEAKERPHONE, VOLUME +/- 3 dedicated Android keys for HOME, RECENT, and BACK
<b>Voice Codec</b>	Wide-band Opus, wide-band G.722, G.711µ/a, G. 729A/B, G.726-32, iLBC, in-band and out-ofband DTMF (In audio, RFC2833, SIP INFO), VAD, CNG, AEC, PLC, AJB, AGC, ANS, Noise Shield 2.0
<b>Video Codec and Capabilities</b>	H.264 BP/MP/HP, video resolution up to 720p, frame rate up to 30 fps, bit rate up to 2Mbps, 3-way video conference (720p@30fps), anti-flickering and auto exposure

<b>Telephony Features</b>	Hold, transfer, forward (unconditional/no-answer/busy), call park/pickup, 10-way audio conference(including the host), shared-call-appearance (SCA) / bridged-line-appearance (BLA), virtual Programmable Key, downloadable contacts (XML, LDAP, up to 1000 items), call record(local and server), call log (up to 1000 records), call waiting, auto answer, XML customization of screen, flexible dial plan, personalized music ringtones and music on hold, server redundancy & failover
<b>Extention Module</b>	Yes, can power up to 4 GBX20 EXT modules which feature a 272x480 color LCD, 20 quick-dial/BLF keys with dual-color LED, 2 navigation keys, and less than 1.2W power consumption per unit.
<b>Sample Applications</b>	<ul style="list-style-type: none"> <li>● <b>Local apps:</b> Contacts, Call History, File Manager, Programmable Key, Settings, Browser, Clock, Voicemail, Calculator, Recorder, GS Market, etc.</li> <li>● Support third-party Android apps.</li> <li>● API/SDK available for advanced custom application development</li> </ul>
<b>Android</b>	Runs Android 11
<b>Applications Deployment</b>	Supports Android 11 compliant applications to be developed, downloaded and run on the device with provisioning control.
<b>HD Audio</b>	Yes, 2 omnidirectional microphones, HD handset and speakerphone with support for wideband audio
<b>Base Stand</b>	Yes, desktop stand with three adjustable levels
<b>QoS</b>	Layer 2 QoS (802.1Q, 802.1p) and Layer 3 (ToS, DiffServ, MPLS) QoS
<b>Security</b>	User and administrator level passwords, random default admin password, MD5 and MD5-sess based authentication, 256-bit AES encrypted configuration file, TLS, SRTP, HTTPS, 802.1x media access control, Kensington Security Slot (Kensington Lock) support, anti-hacking secure boot
<b>Multi-language</b>	English, German, Italian, French, Spanish, Portuguese, Russian, Croatian, Chinese, Korean, Japanese, and more
<b>Upgrade/Provisioning</b>	Firmware upgrade via TFTP / HTTP / HTTPS or local HTTP upload, mass provisioning using TR-069 or AES encrypted XML configuration file, GDMS <b>Note:</b> Users can remotely access the GXV3450's web interface through the GDMS device options menu.
<b>Power &amp; Green Energy Efficiency</b>	Universal power adapter included: Input: 100-240VAC 50-60Hz; Output 12VDC 1.5A (18W) Integrated PoE* 802.3af Class 3, PoE+ 802.3at, Class 4 <i>*Must use PSU or PoE+ to power up the phone when using USB devices</i>
<b>Temperature and Humidity</b>	<b>Operation:</b> 0°C to 40°C <b>Storage:</b> -10°C to 60°C <b>Humidity:</b> 10% to 90% Non-condensing
<b>Package Content</b>	GXV3450 phone, handset with cord, base stand, universal power supply, network cable, screen cleaning cloth, quick installation guide
<b>Compliance</b>	<b>FCC:</b> CFR 47 Part 15 Subpart B Class B; CFR 47 Part 15 Subpart C; CFR 47 Part 15 Subpart E; Part 68 (HAC) <b>IC:</b> RSS-247, RSS-GEN, RSS-102, ICES-003, CS-03 <b>CE:</b> EN 55032 Class B;EN 55035; EN IEC 61000-3-2; EN 61000-3-3; EN IEC 62368-1; ETSI EN 300328; ETSI EN 301893; ETSI EN 301489-1; ETSI EN 301489-17; EN IEC

62311

**UKCA:** BS EN 55032 Class B; BS EN 55035; BS EN IEC 61000-3-2; BS EN 61000-3-3; BS EN IEC 62368-1; ETSI EN 300328; ETSI EN 301893; ETSI EN 301489-1; ETSI EN 301489-17; BS EN IEC 62311

**RCM:** AS/ACIF S040 AS/CA S004; AS/NZS CISPR 32; AS/NZS 62368.1; AS/NZS 4268 RoHS2.0

*GXV3450 Technical Specifications*

## GETTING STARTED

This chapter provides basic installation instructions including the list of the packaging contents and also information for obtaining the best performance with the GXV34x0 series.

### Equipment Packaging

o **GXV3480**

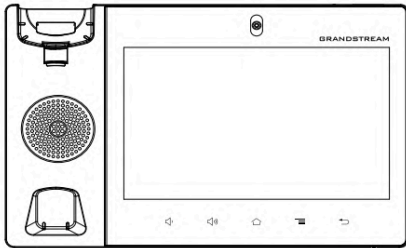

1x GXV3480 Main Case

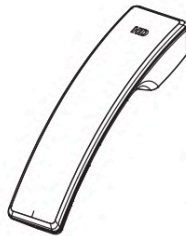

1x Handset

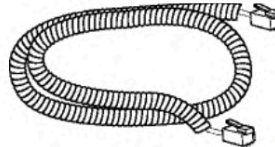

1x Phone Cord

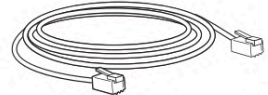

1x Ethernet Cable



1x 12V Power Adapter



1x Quick Installation Guide

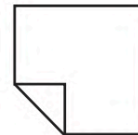

1x Screen Cleaning Cloth

*GXV3480 Package Content*

GXV3480
<ul style="list-style-type: none"><li>• 1x GXV3480 Main Case.</li><li>• 1 x Handset.</li><li>• 1x Phone Cord.</li><li>• 1x Ethernet Cable.</li><li>• 1x 12V Power Adapter.</li><li>• 1x Screen Cleaning Cloth.</li><li>• 1x Quick Installation Guide.</li></ul>

*GXV3480 Equipment Packaging*

o **GXV3470**

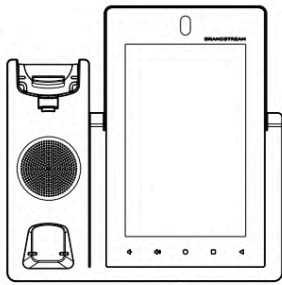

1x GXV3470 Main Case



1x Handset

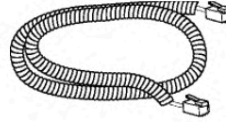

1x Phone Cord

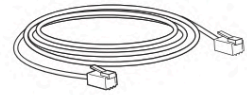

1x Ethernet Cable



1x 12V Power Adapter



1x Quick Installation Guide

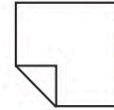

1x Screen Cleaning Cloth

*GXV3470 Package Contents*

GXV3470
<ul style="list-style-type: none"> <li>• 1x GXV3470 Main Case.</li> <li>• 1 x Handset.</li> <li>• 1x Phone Cord.</li> <li>• 1x Ethernet Cable.</li> <li>• 1x 12V Power Adapter.</li> <li>• 1x Wall Mount.</li> <li>• 1x Screen Cleaning Cloth.</li> <li>• 1x Quick Installation Guide.</li> </ul>

*GXV3470 Equipment Packaging*

o GXV3450

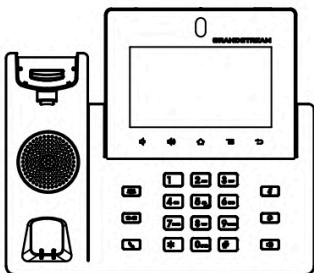

1x GXV3450 Main Case



1x Handset

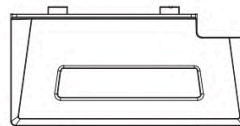

1x Phone stand



1x Quick Installation Guide

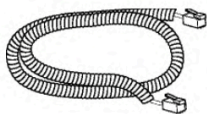

1x Phone Cord

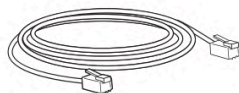

1x Ethernet Cable



1x 12V Power Adapter

*GXV3450*

## GXV3450

- 1x GXV3450 Main Case.
- 1 x Handset.
- 1x Phone Cord.
- 1x Phone Stand
- 1x Ethernet Cable.
- 1x 12V Power Adapter.
- 1x Quick Installation Guide.

### GXV3450 Equipment Packaging

#### Important

Check the package before installation. If you find anything missing, contact your system administrator.

## Description of the GXV34x0

### GXV3480

#### ○ Front View

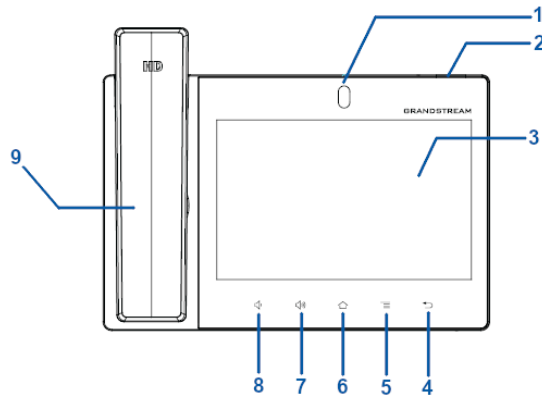

GXV3480 Front

Item	Name	Description
1	Front Camera	Mega pixel front camera. The angle can be adjusted, and the camera can be blocked by scrolling up/down the wheel on the back of the camera.
2	MWI LED Indicator	To indicate message status, call status and phone's system status using the LED indicator.
3	LCD	8" (1280×800) capacitive (10 points) IPS LCD touch screen.
4	Back	Tap to go back to the previous menu.
5	Menu	Press MENU key to access phone's display settings, edit widgets and thread manager. Or press and hold on the MENU key for 2 seconds to enter managing application interface directly.
6	Home	Tap to go back to <b>Home</b> screen; or touch and press for about 2 seconds to take a screenshot of phone's screen.
7	Volume Up	Tap to turn up the call volume and media volume.

8	<b>Volume Down</b>	Tap to turn down the call volume and media volume.
9	<b>Handset</b>	Off hook to use handset as the audio channel for calls and media.

Table 8: GXV3480 Front View

o **Back View**

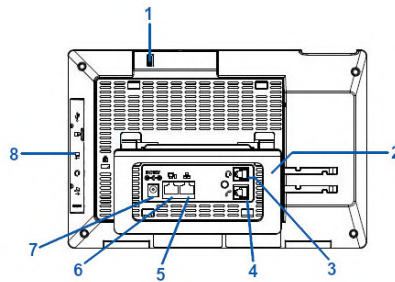

GXV3480 Back View

Item	Name	Description
1	<b>Camera Adjusting Wheel</b>	Scroll up/down to adjust the camera angle.
2	<b>Phone Stand (built-in)</b>	Adjust the phone stand angle to place the phone on the desk.
3	<b>Headset Port</b>	RJ9 headset connector port (supporting EHS with Plantronics headset).
4	<b>Handset Port</b>	RJ9 handset connector port.
5	<b>LAN Port</b>	10/100/1000Mbps RJ-45 port connecting to Ethernet.  PoE/PoE+ is supported.
6	<b>PC Port</b>	10/100/1000Mbps RJ-45 port connecting to PC.
7	<b>Power Jack</b>	12V DC Power connector port.
8	<b>Side Connectors Cover</b>	USB 3.0 port, Type-C, HDMI-out, 3.5mm headset port, HDMI-in

Table 9: GXV3480 Back View

o **Side View**

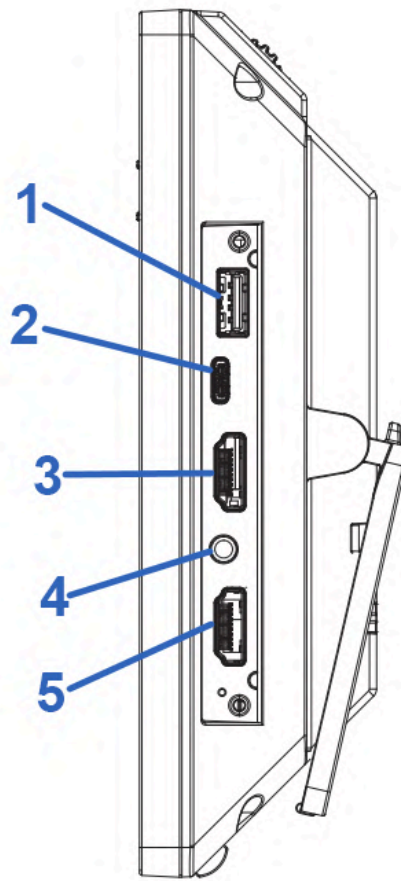

GXV3480 Side View

Item	Name	Description
1	<b>USB Port</b>	USB devices can be connected via the USB port. For example, connect a USB flash drive to save captured pictures.
2	<b>Type-C port</b>	Used for USB Device mode. Connect the GXV3480 to a USB Host device, such as a PC, the GXV3480 will act as its USB external audio device.
3	<b>HDMI Output Interface</b>	Connect to HDMI input devices (e.g., TV)
4	<b>3.5mm Headset Port</b>	Connect 3.5mm headset.
5	<b>HDMI Input Interface</b>	Connect presentation device (e.g., a laptop).

Table 10: GXV3480 Side View

## GXV3470

- **Font View**



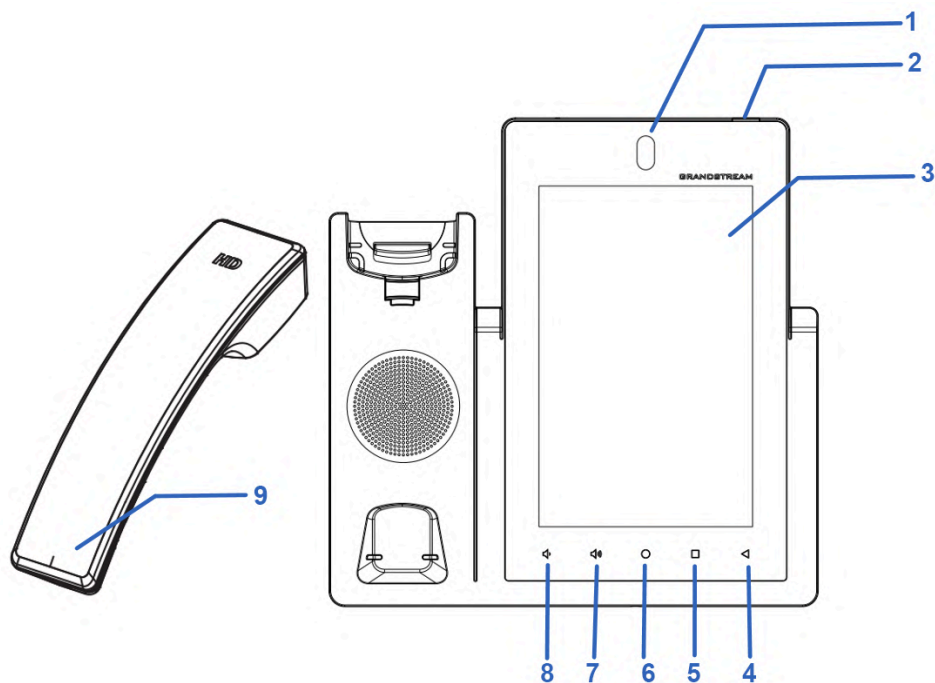

GXV3470 Front View

Item	Name	Description
1	<b>Front Camera</b>	Mega pixel front camera. The angle can be adjusted, and the camera can be blocked by scrolling up/down the wheel on the back of the camera.
2	<b>MWI LED Indicator</b>	To indicate message status, call status and phone's system status using the LED indicator.
3	<b>LCD</b>	7" (1280×800) capacitive (5 points) IPS LCD touch screen.
4	<b>Back</b>	Tap to go back to the previous menu.
5	<b>Menu</b>	Press MENU key to access phone's display settings, edit widgets and thread manager. Or press and hold on the MENU key for 2 seconds to enter managing application interface directly.
6	<b>Home</b>	Tap to go back to <b>Home</b> screen; or touch and press for about 2 seconds to take a screenshot of phone's screen.
7	<b>Volume Up</b>	Tap to turn up the call volume and media volume.
8	<b>Volume Down</b>	Tap to turn down the call volume and media volume.
9	<b>Handset</b>	Off hook to use handset as the audio channel for calls and media.

Table 11: GXV3470 Front View

o **Back View**

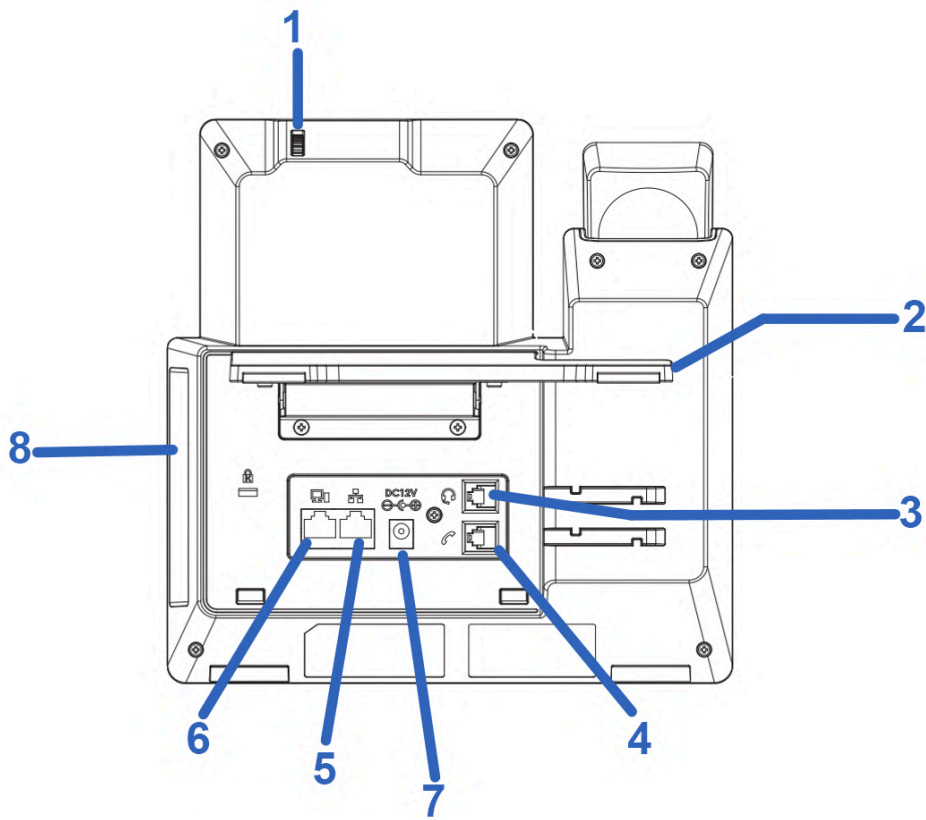

GXV3470

Item	Name	Description
1	<b>Camera Adjusting Wheel</b>	Scroll up/down to adjust the camera angle.
2	<b>Phone Stand (built-in)</b>	Adjust the phone stand angle to place the phone on the desk.
3	<b>Headset Port</b>	RJ9 headset connector port (supporting EHS with Plantronics headset).
4	<b>Handset Port</b>	RJ9 handset connector port.
5	<b>LAN Port</b>	10/100/1000Mbps RJ-45 port connecting to Ethernet. PoE/PoE+ is supported.
6	<b>PC Port</b>	10/100/1000Mbps RJ-45 port connecting to PC.
7	<b>Power Jack</b>	12V DC Power connector port.
8	<b>Side Connectors Cover</b>	USB 3.0 Port, USB 2.0 Port, HDMI Port, 3.5mm Headset Port

Table 12: GXV3470 Back View

o Side View

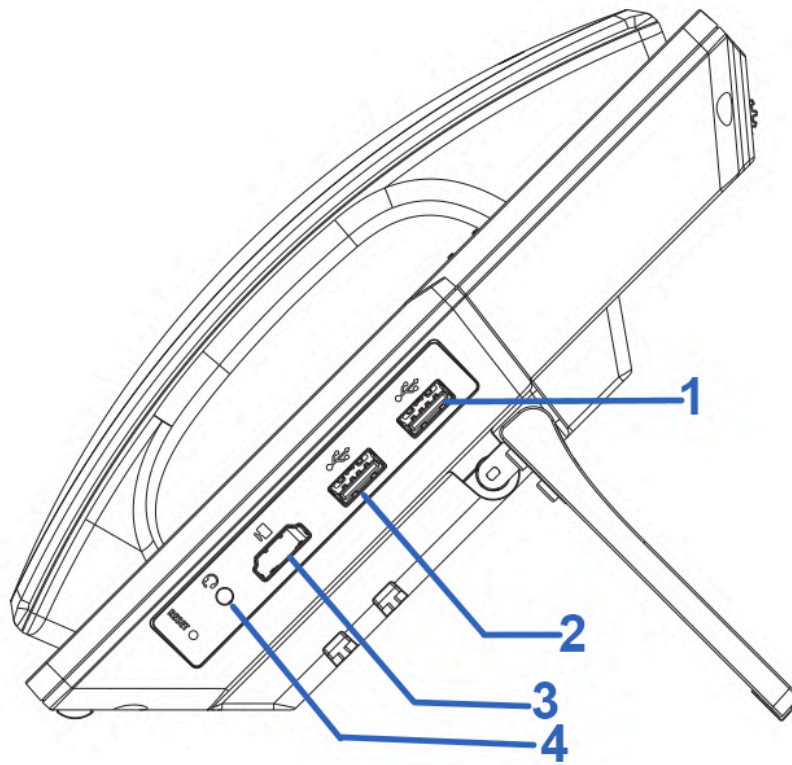

GXV3470 Side View

Item	Name	Description
1	USB 3.0 Port	Faster USB 3.0 port to storage as an example.
2	USB 2.0 Port	USB devices can be connected via the USB port. For example, connect a USB flash drive to save captured pictures.
3	HDMI Port	Connect display device to the HDMI port via HDMI cable.
4	3.5mm Headset Port	Connect 3.5mm headset.

Table 13: GXV3470 Side View

### GXV3450

o Front View

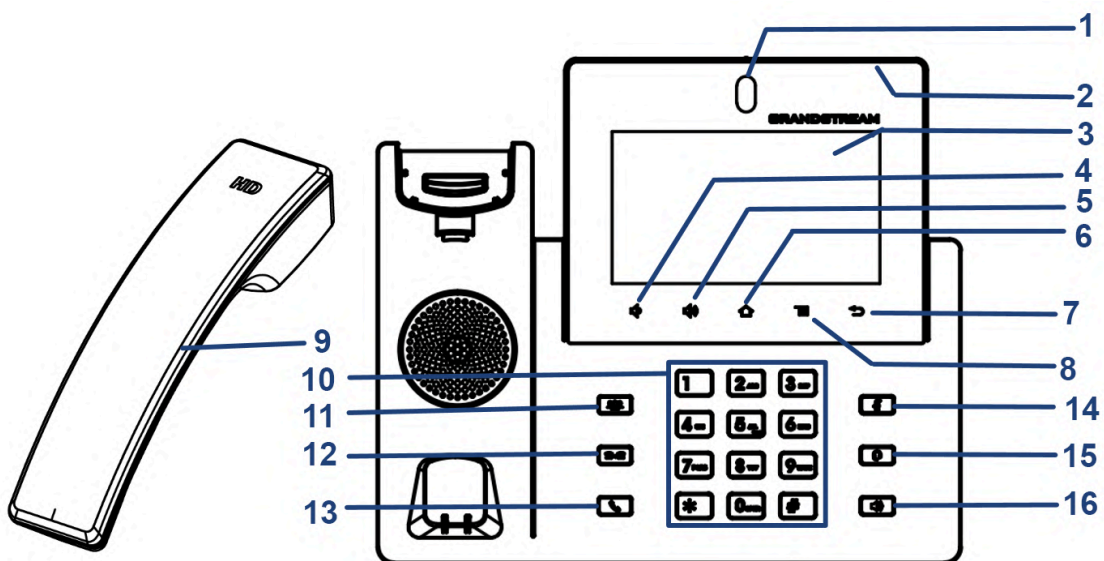

GXV3450 Front View

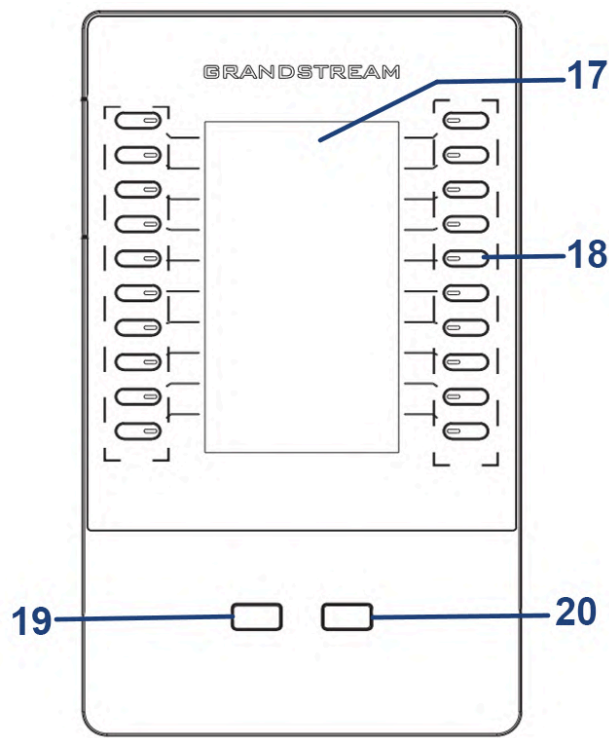

GXV3450 GBX20 Extension Module Front

Item	Name	Description
1	Front Camera	Mega pixel front camera. The angle can be adjusted, and the camera can be blocked by scrolling up/down the wheel on the back of the camera.
2	MWI LED Indicator	To indicate message status, call status and phone's system status using the LED indicator.
3	LCD	5 (1280*720) capacitive (5 points) touch screen.
4	Volume Down	Tap to turn down the call volume and media volume.
5	Volume Up	Tap to turn up the call volume and media volume.
6	Home	Tap to go back to Home screen; or touch and press for about 2 seconds to take a screenshot of phone's screen.
7	Menu	Press MENU key to access phone's display settings, edit widgets and thread manager. Or press and hold on the MENU key for 2 seconds to enter managing application interface directly.
8	Back	Tap to go back to the previous menu.
9	Handset	Off hook to use handset as the audio channel for calls and media.
10	Keypad	Tap to dial or send DTMF
11	Conference	Tap to enter into conference, then make an online meeting
12	Transfer	Tap to transfer the call
13	Dial/Send	Tap to make a call

14	<b>Mute</b>	Mute / Unmute the call. Or enable DND when free
15	<b>Earphone</b>	Tap to enter into the dial interface or switch the media channel to earphone
16	<b>Speaker</b>	Tap to enter into the dial interface or switch the media channel to speaker
17	<b>GBX20 LCD</b>	272*480 color LCD
18	<b>Multiple Button</b>	Tap to make all kinds of call, like speed dial, BLF and so on
19	<b>Turn Last Page</b>	Turn last page
20	<b>Turn Next Page</b>	Turn next page

GXV3450 Front View

o **Back View**

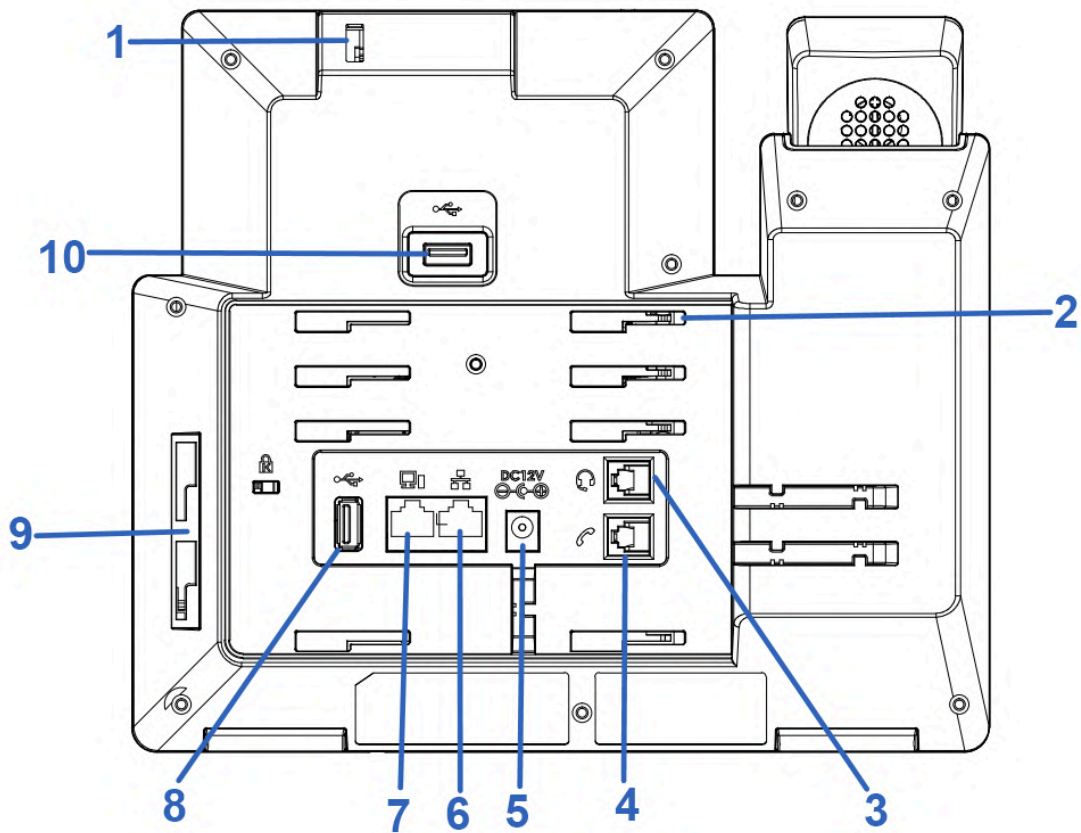

GXV3450 Back View

Item	Name	Description
1	<b>Camera Adjusting Wheel</b>	Scroll up/down to adjust the camera angle.
2	<b>Phone Stand Slot</b>	Put the phone stand from left to right into the slots.
3	<b>Handset Port</b>	RJ9 handset connector port.
4	<b>Headset Port</b>	RJ9 headset connector port (supporting EHS with Plantronics headset).
5	<b>Power Jack</b>	12V DC Power connector port.

6	LAN Port	10/100/1000Mbps RJ-45 port connecting to Ethernet. PoE/PoE+ is supported
7	PC Port	10/100/1000Mbps RJ-45 port connecting to PC.
8	USB Port 2.0	USB devices can be connected via the USB port. For example, connect a USB flash drive to save captured pictures.
9	Side GBX20 Connection Slot	The slots for connecting GXV3450 and GBX20.
10	USB 3.0	USB devices can be connected via the USB port. For example, connect a USB flash drive to save captured pictures.

Table 15: GXV3450 Back View

## Connecting and Setting Up the GXV34x0

The GXV34x0 can be installed on the desktop using the built-in stand or attached on the wall using the slots for wall mounting.

### Using the Phone Stand

- o **GXV3480**

The GXV3380 has a built-in phone stand. To use it, pull out the phone stand handle on the back of the phone. Adjust the angle as preferred and make sure the phone stands still on the desktop. (see figure below).

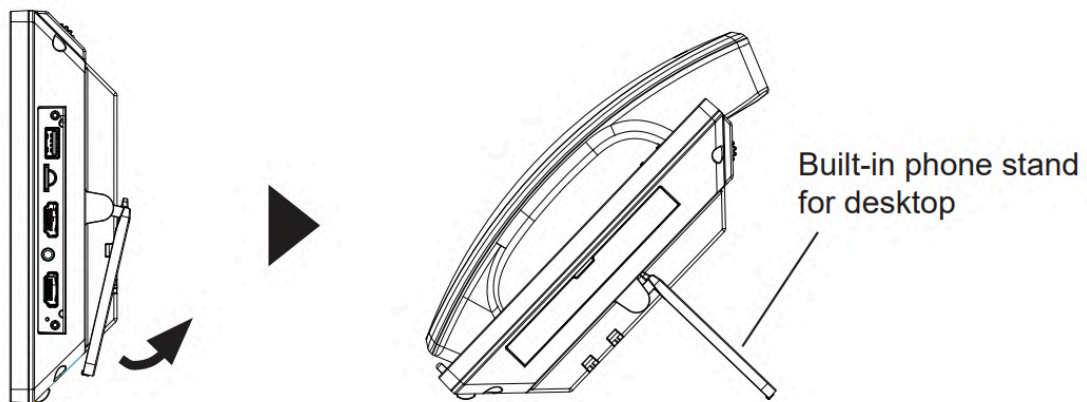

GXV3480 Phone Stand

- o **GXV3470**

For installing the phone on the table with the phone stand, attach the phone stand by screwing the 4 screws on the upper half side using a Philips head screwdriver (see figure below).

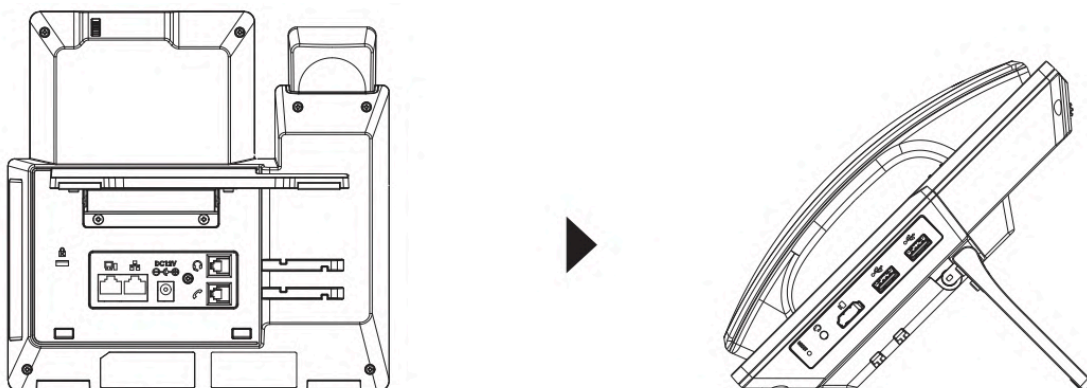



o **GXV3450**

For installing the phone on the table with the phone stand, attach the phone stand to the bottom of the phone where there is a slot for the phone stand, (upper half, bottom part).

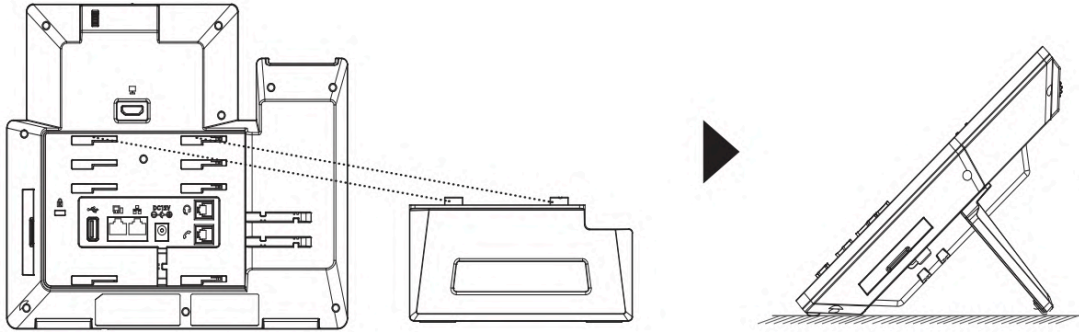

GXV3450 Phone Stand

**Using the Slots for Wall Mounting**

o **GXV3480**

1. Attach the wall mount to the slots on the back of the phone;
2. Attach the phone to the wall via the wall mount hole;
3. Pull out the tab from the handset cradle (see figure below);
4. Rotate the tab and plug it back into the slot with the extension up to hold the handset while the phone is mounted on the wall.

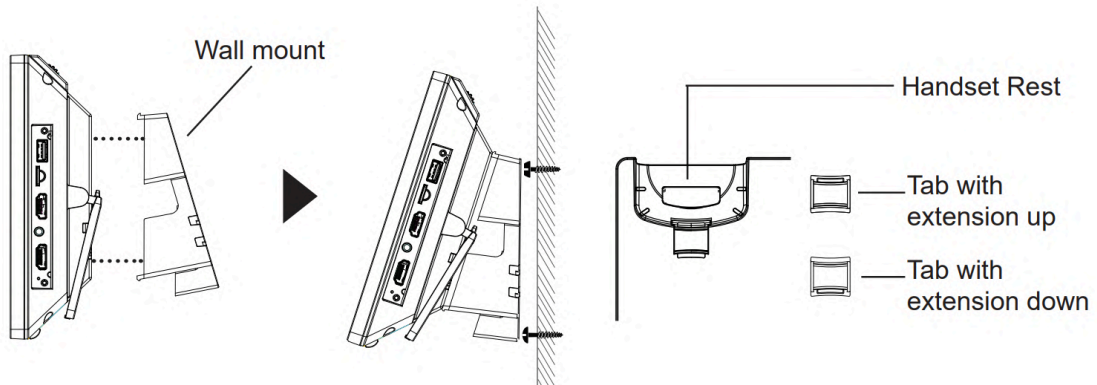

GXV3480 Wall Mount

o **GXV3470**

1. Remove the desktop bracket by unscrewing the 4 screws with a Philips head screwdriver.
2. Attach the wall mount to the slots on the back of the phone.
3. Attach the phone to the wall via the wall mount hole.
4. Pull out the tab from the handset cradle (see figure below).
5. Rotate the tab and plug it back into the slot with the extension up to hold the handset while the phone is mounted on the wall.

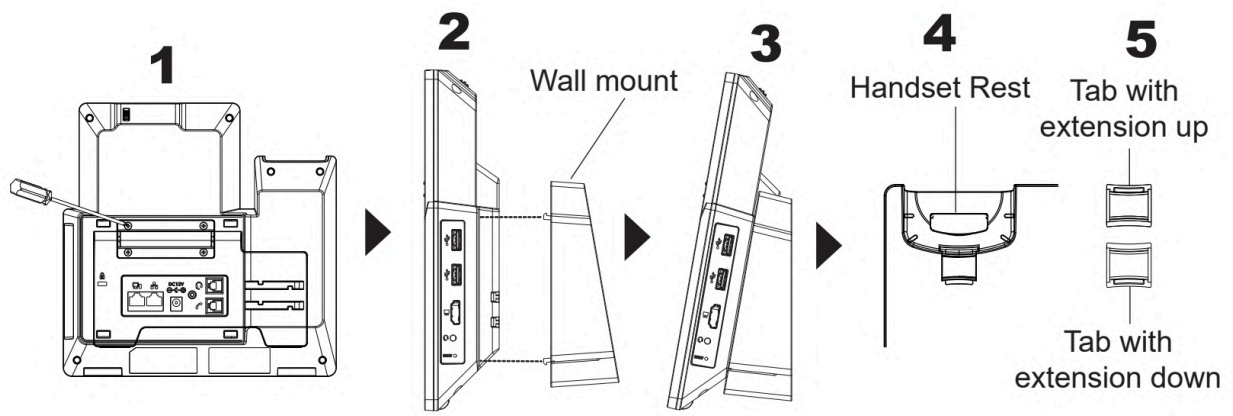

GXV3470 Wall Mount

o **GXV3450**

1. Attach the wall mount spacers to the slot for wall mount spacers on the back of the phone.
2. Attach the phone to the wall via the wall mount hole.
3. Pull out the tab from the handset cradle (see figure below).
4. Rotate the tab and plug it back into the slot with the extension up to hold the handset while the phone is mounted on the wall.

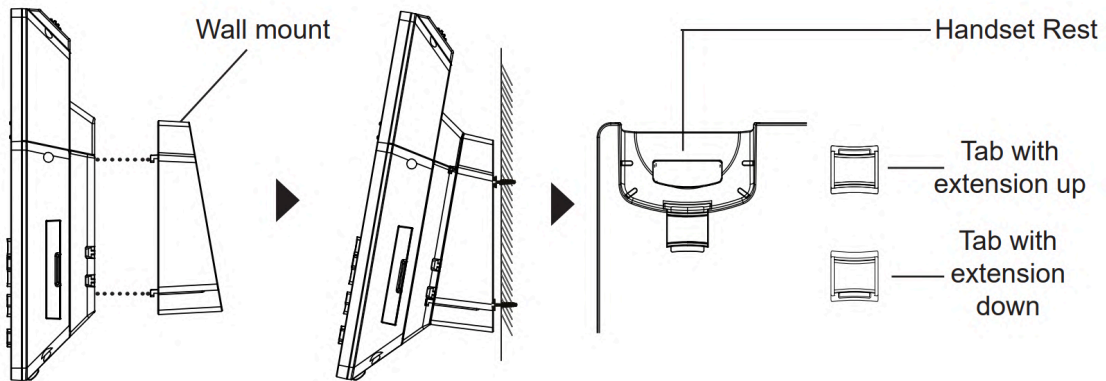

GXV3450 Wall Mount

## Connecting the GXV34x0

To setup your GXV34x0, please follow the steps below:

1. Connect the handset and main phone case with the phone cord;
2. Connect the LAN port of the phone to the RJ-45 socket of a hub/switch or a router (LAN side of the router) using the Ethernet cable;
3. Connect the 12V DC output plug to the power jack on the phone; plug the power adapter into an electrical outlet. If PoE switch is used in step 2, this step could be skipped;
4. The LCD will display booting up or firmware upgrading information. Before continuing, please wait for the main screen display to show up;
5. Using the web configuration interface or from the menu of the touch screen, you can further configure network connection using static IP, DHCP etc.



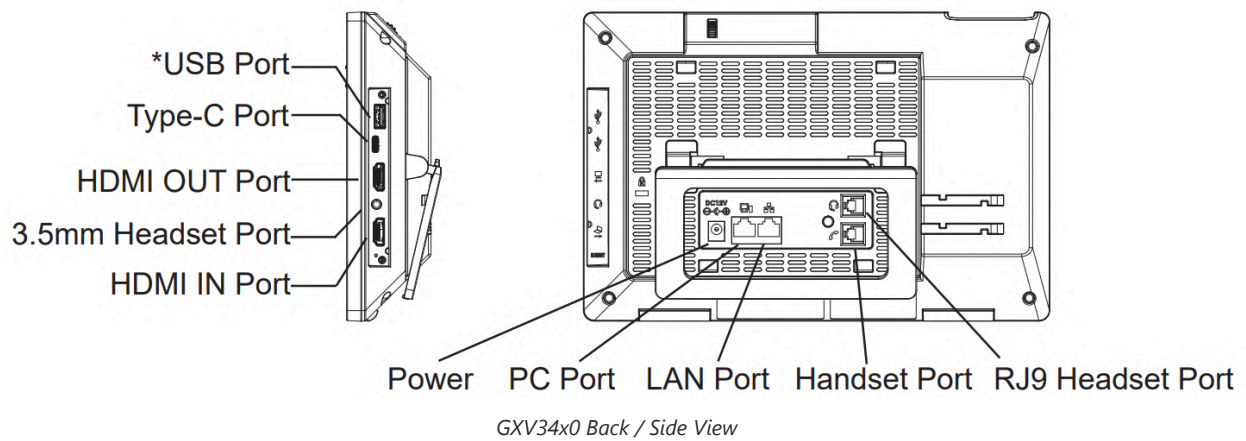

**Note**

USB, HDMI-in and HDMI-out will be disabled when using PoE, and enable if using power supply or PoE+

**Cleaning the Phone**

For daily dust removal and fingerprint removal, please use the screen cleaning cloth in the factory package to wipe the phone. For some special cases like medical environment, you can use medical alcohol or isopropanol. The steps are as followed:

1. Before cleaning the phone, stop using it and disconnect it from the power supply.
2. Spray a small amount of disinfectant on screen, camera, handle and other places that are easily touched by users.
3. Wipe the phone with screen cleaning cloth.
4. Power on until the disinfectant is completely volatilized.

**Important**

- o Keep the power plug clean and dry, or may lead to electric shock or other perils.
- o DO NOT use disinfectant too frequently.
- o DO NOT use high degree or even pure disinfectant. It could damage the phone.

**GETTING TO KNOW GXV34x0**

**Use the Touchscreen**

When the phone boots up in HOME screen, the LCD will display as below. A registered account is shown in the following figure and users might need register their own account to have the account status displayed.

The Status Bar shows time, network connectivity, signal strength, notification information etc...

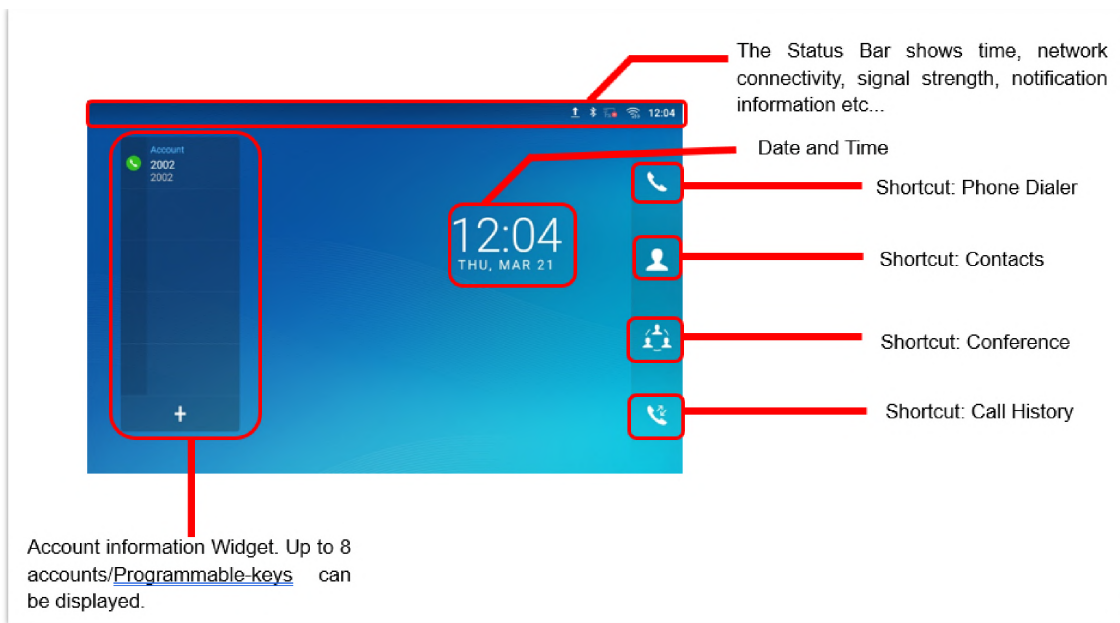

Figure 20: GXV3480 Default Home Screen

Swipe from right to left to show the application menu of the phone. the settings and applications installed will be brought up as shown below.

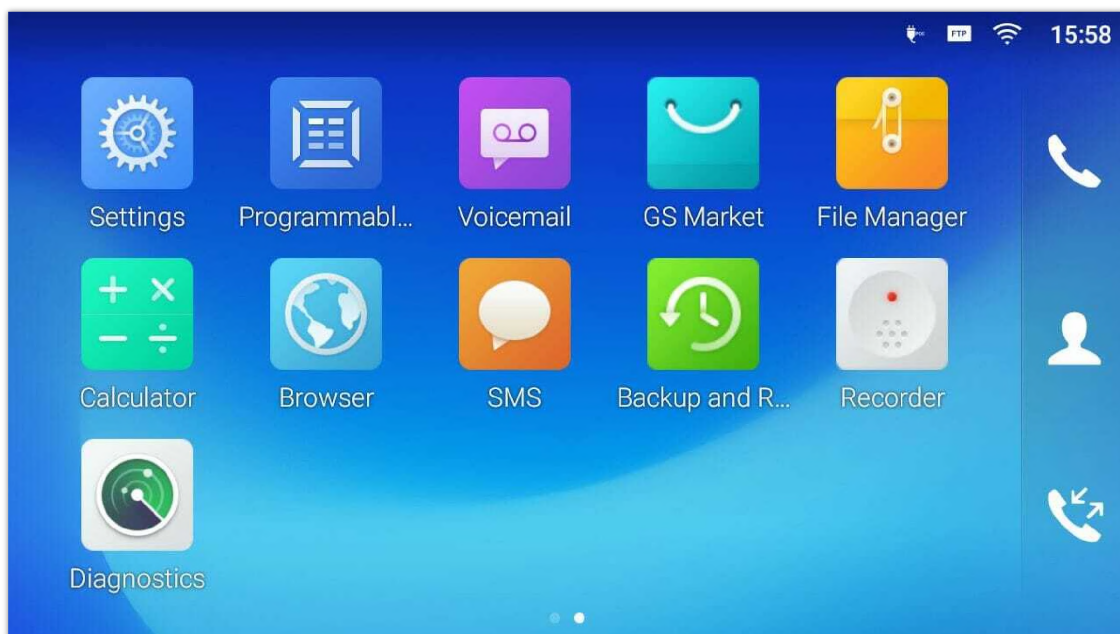

Figure 21: GXV3450 Onscreen Menu

To fully manipulate the GXV34x0 capacitive touch screen, use your fingers to operate the following on the GXV34x0 icons, buttons, menu items, onscreen keyboard etc.

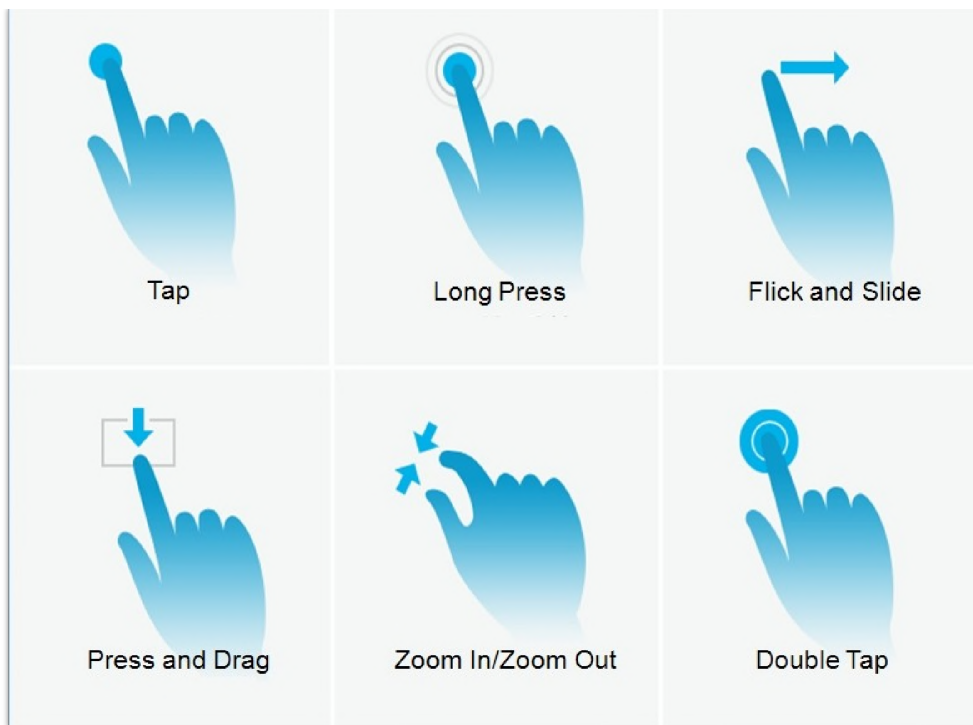

Figure 22: GXV34x0 Finger Gestures on the Touch Screen

- **Tap**

Slightly touch the screen with fingertip to initiate menu, options or applications. For example, to select items on the screen (e.g., setting options, apps etc.); to press onscreen buttons (e.g., “End” or “Options” softkey during the call); to type letters and symbols using the onscreen keyboard.

- **Long Press**

Touch the screen with fingertip and press for about 2 seconds without lifting your finger from the screen till an action occurs. For example, long press on a picture to bring up selection option.

- **Flick and Slide**

Touch the screen with fingertip and slide over the screen. For example, user could slide up to scroll up the page, slide down to open dropdown menu, slide left or slide right to delete an item from the list. If your finger stays on the screen for too long, the item may be selected, and sliding won't occur.

- **Press and Drag**

Touch and press the item, then move it by dragging it up, down, left or right, without lifting your finger from the screen.

- **Zoom In/Zoom Out**

Place two fingers on the screen, then pinch them together (zoom out) or spread them apart (zoom in).

- **Double Tap**

Quickly touch the screen twice with fingertip to switch between default display and zoomed-in display. This is usually used when viewing photos or web pages.

## Use the Desktop

### Desktop Menu

When the GXV34x0 is on idle screen, long tap on the screen or press the menu key  to bring up phone's menu. Users can access the following in the desktop menu:

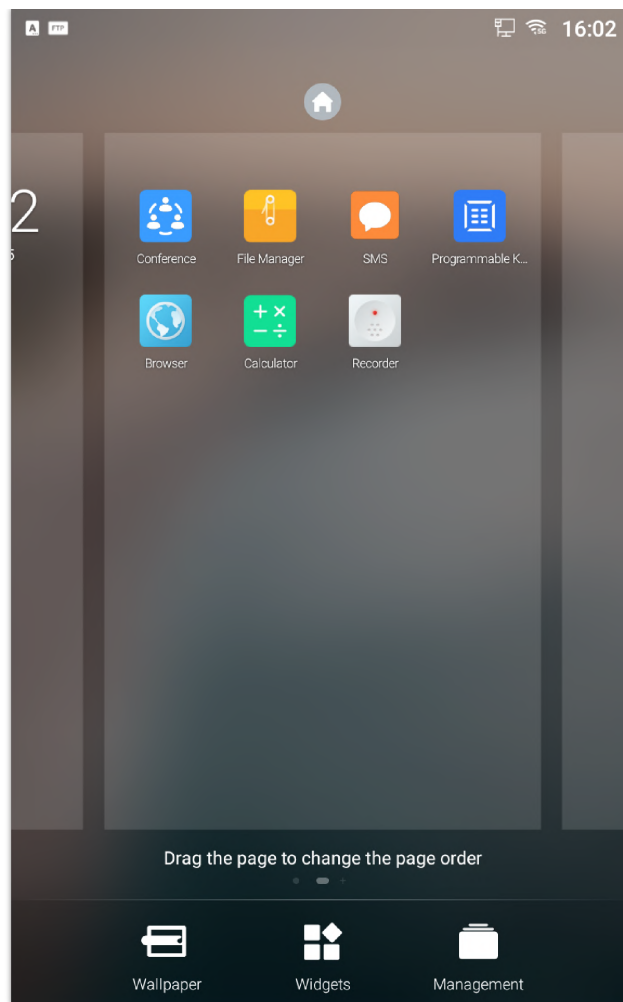

Figure 23: GXV3470 Desktop Menu

- **Desktop page**

Add, delete or edit desktop pages, set Home page and change the screen sequence.

- **Wallpaper**

Select wallpaper from Local gallery or from the available system Wallpapers

- **Widgets**

Add widgets to the desktop by touching and holding the widget from the widget menu.

- **Management**

Manage running applications on the GXV34x0. For more details, please refer to section [**Manage Running Applications**].

## Add Widget to Desktop

The GXV34x0 provides widgets like account bar, clock, contacts etc. Users could conveniently add those widgets to the desktop as preferred. To add a widget:

1. Press the Menu key  or long press on an empty space on the idle screen and select "Widgets".
2. Different widgets will be displayed on the right side of the screen.
3. Select and drag the widget to the desired spot to be placed on the desktop. Please make sure there is enough space on the desktop. Otherwise, the widget won't be added.



Figure 24: Add Widget to the Desktop

#### Note

The user has the possibility to disable desktop widget editing from the GXV GUI Config Tool, under **GUI Config Tool => Layout Settings => Disable Desktop Management**.

Please refer to the [GUI Customization Web Tool Guide](#) for more information on how to disable the option.

## Manage Desktop Items

On the GXV34x0 desktop, users could tap on the desktop items to manage shortcuts and widgets. The following operations can be done:

- **Tap on the shortcut icon to open the application.**

For example, tap on "File Manager" icon  to access file manager application.

- **Tap on the widget to open and edit it.**

For example, tap on the digital clock on the desktop. The clock settings will be brought up for users to set up timer, stopwatch or alarm.

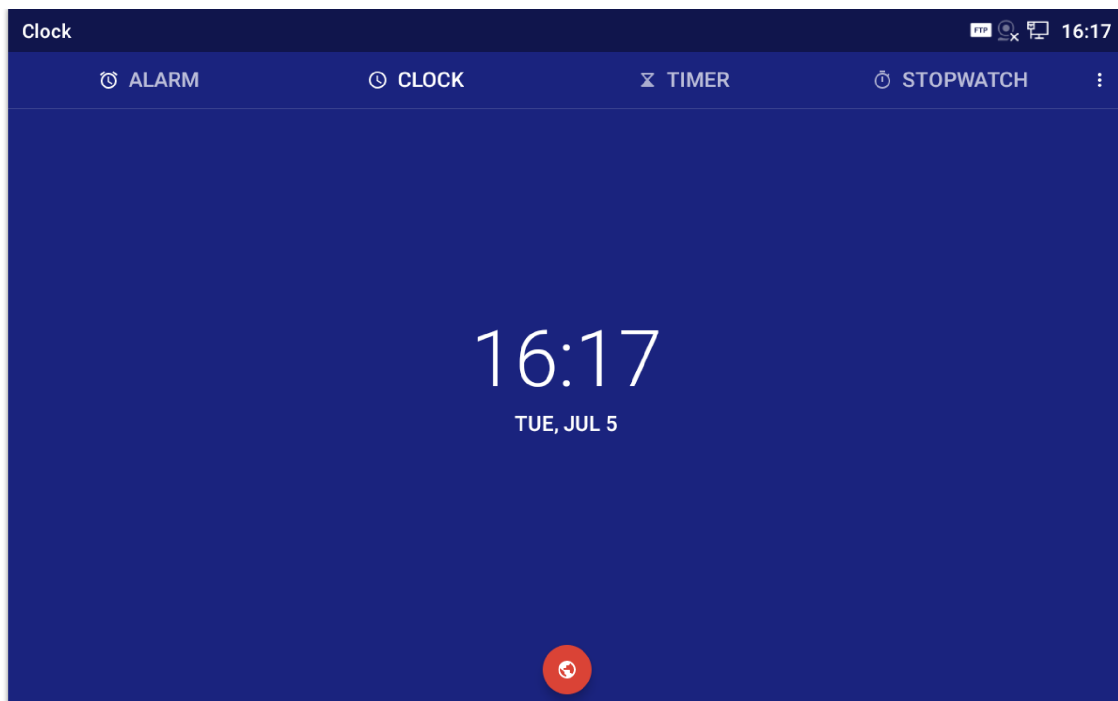

Figure 25: Open Clock Widget

- **Certain widgets such as the MPK Widget can be resized on the desktop.**

To resize a widget, press and hold the widget for about 2 seconds. Then lift your finger from the screen. This will bring up the white frame as shown in the following figure. Touch and drag the border of the frame to adjust the size.

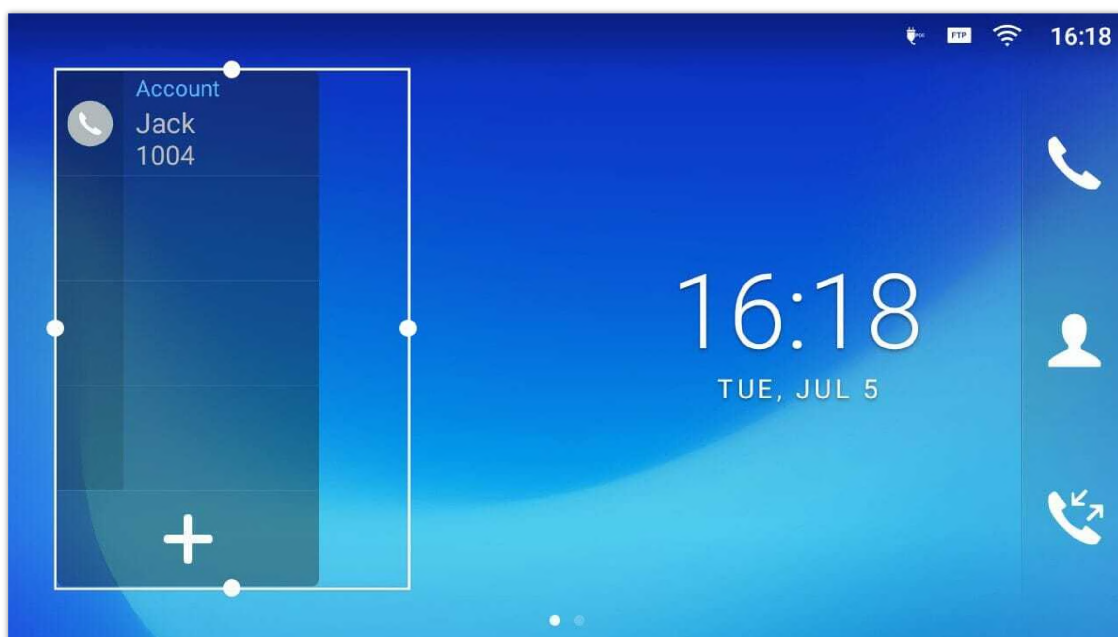

Figure 26: Resize MPK Widget

- **Move/delete Application/Widget**

To move a shortcut/widget to a different spot on the desktop or to a different idle screen, touch and press the item for about 1 seconds until a recycle bin icon shows up on the top of the screen.

Drag the item up/down/left/right to the destination spot on the screen. Lift your finger once done. To delete the item/widget, press on it for about 1 seconds then move it to the recycle bin on the top of the screen.



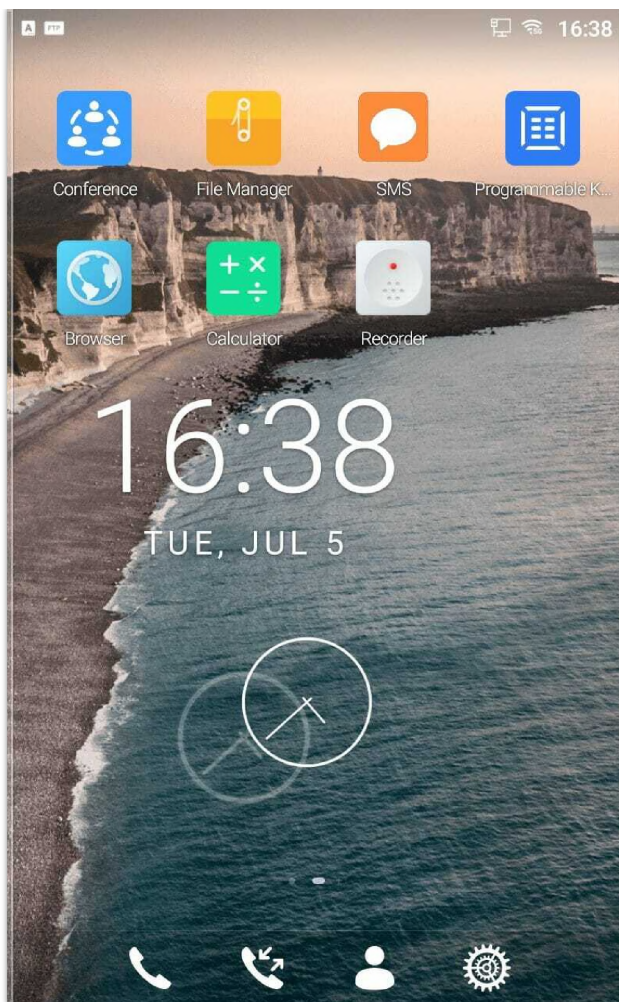

Figure 27: Move Clock Widget

- **Group Apps into folders on home screen**

To group different Apps in a folder, hold press on the app and drag it on top of the other app the folder will be created with a dark background showing icons of the Apps added.

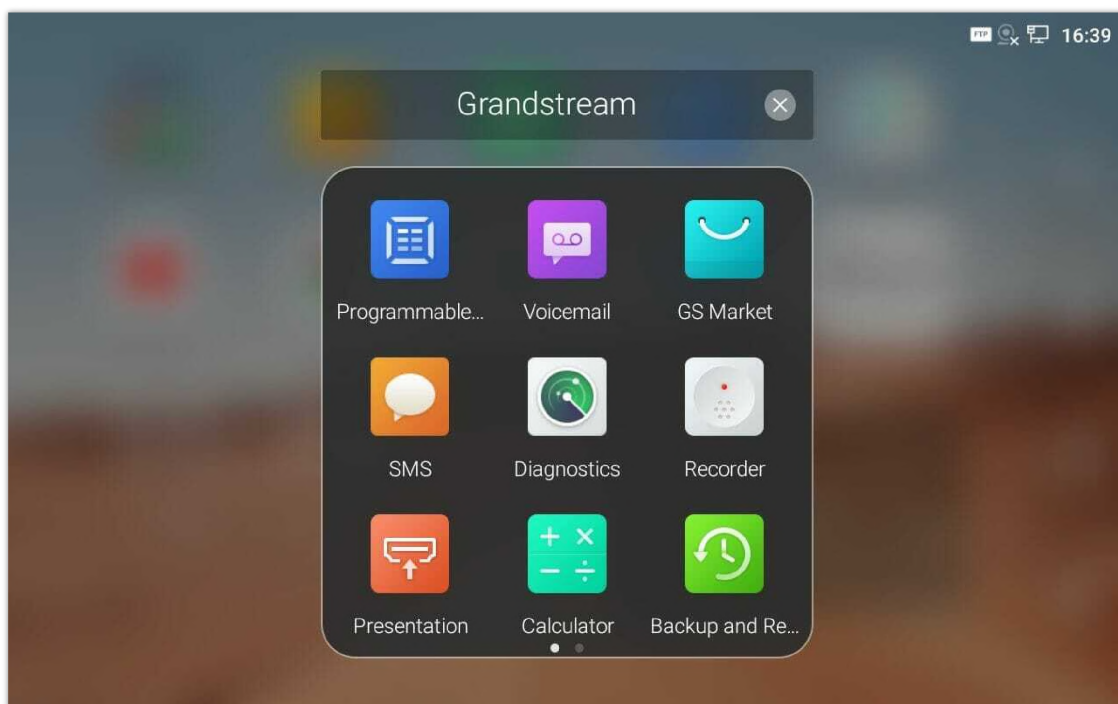



Figure 28: Grouping apps in one folder

Tap the folder to display the Apps included, you can rename the folder by touching the upper box to display the keyboard.

**Note**

Deleting an application icon will systematically pop up a window asking the permission to uninstall the application from the screen. Press ok to uninstall or press cancel to abort.

## Set Wallpapers

On the GXV34x0 desktop, touch and press on an empty spot for about 2 seconds or users could press menu key  and select "Wallpaper" to set up the wallpaper for the desktop. Users could select wallpaper from different categories:

- o **Local**

Open Gallery application and tap on the picture to preview. Touch and drag the picture to adjust the frame that will be used as wallpaper. Then tap on "Set Wallpaper" to set the selected area of the picture as wallpaper.

- o **Wallpapers**

On the right side of the Wallpaper menu of the GXV34x0. Select the picture from the default wallpapers available to preview and then tap on "Set wallpaper".

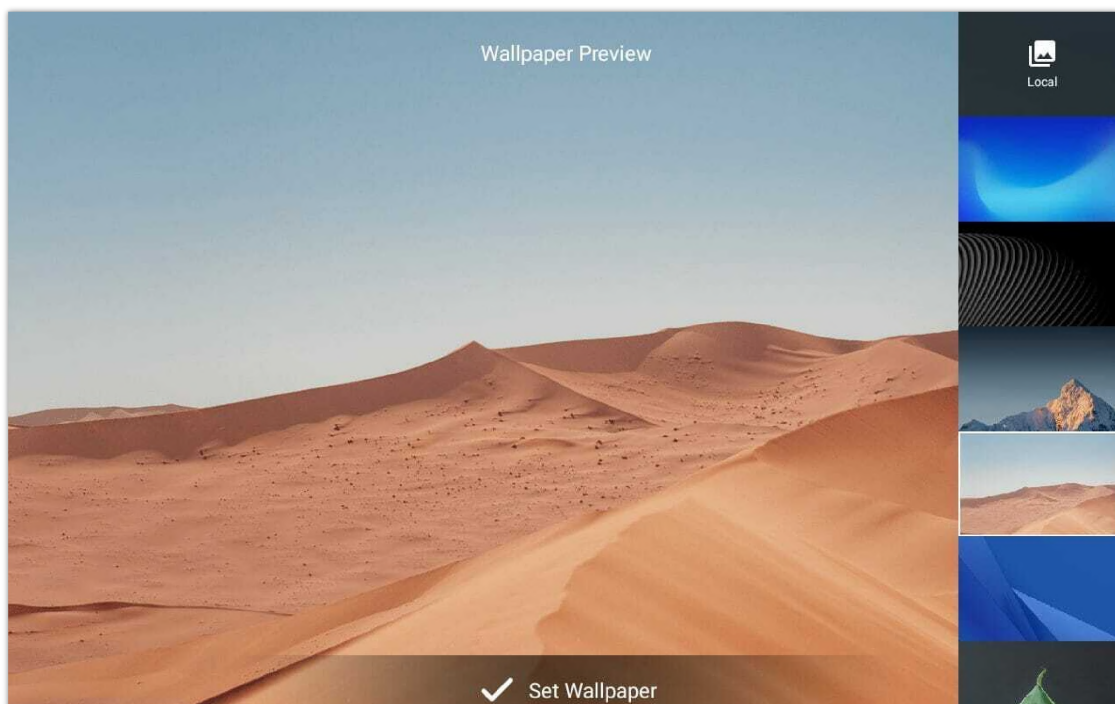



Figure 29: GXV34x0 Choose Wallpaper

## Set Programmable Key Widget

On the GXV34x0 desktop, touch and press on an empty spot for about 2 seconds or press menu key  and select Widgets to display available choices, Long press the Programmable key widget to add It to the desktop (users can choose from multiple sizes; 1xN, 2xN or 3xN).



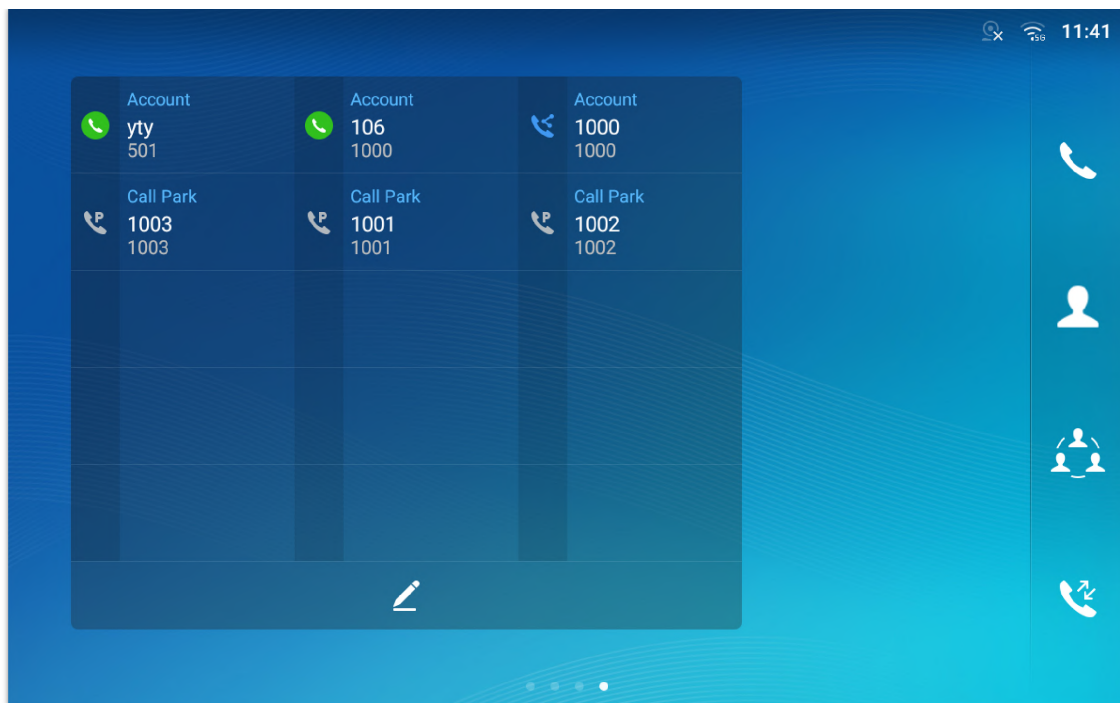



Figure 30: Programmable Key Widget

Press the modify icon  to show all the programmable key, then press the plus sign to add and configure of those options (Speed dial, Busy lamp field, Call transfer, Intercom, Speed dial via active account, Dial DTMF, Call park Multicast paging, Dial prefix, and Speed conference)

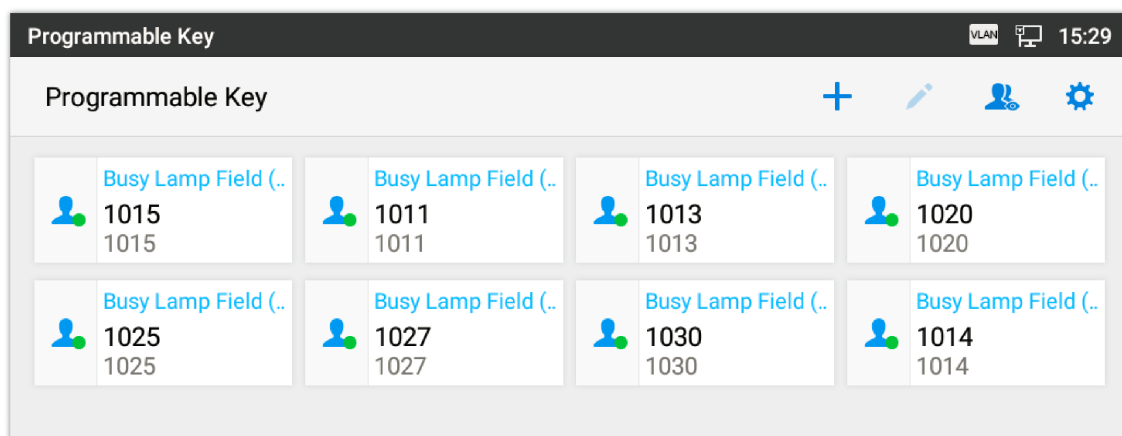



















Figure 31: Programmable Keys Page

## Programmable Key Indicators

The following table shows the indicator status in different scenarios:

Indicator	Status
	Account Not Registered
	Account Registered
	Account Registering

	Account Call Park
	Dial Prefix
	Speed Dial
	Transfer
	Dial DTMF
	Intercom
	Multicast Paging
	Speed Conference
	BLF Offline
	BLF Busy
	BLF Online
	Call Park Offline
	Call Park Busy
	Call Park Hold
	Call Park Online









	SCA Call Park Offline
	SCA Call Park Busy
	SCA Call Park Hold
	SCA Call Park Online
	SCA account
	SCA Account Busy
	SCA Account Hold
	SCA Account Online

Table 16: Programmable Key Indicator

## Manage Running Applications

On the GXV34x0 desktop, press an empty spot for about 2 seconds then select "Management" or select "Management" after pressing Menu button ☰

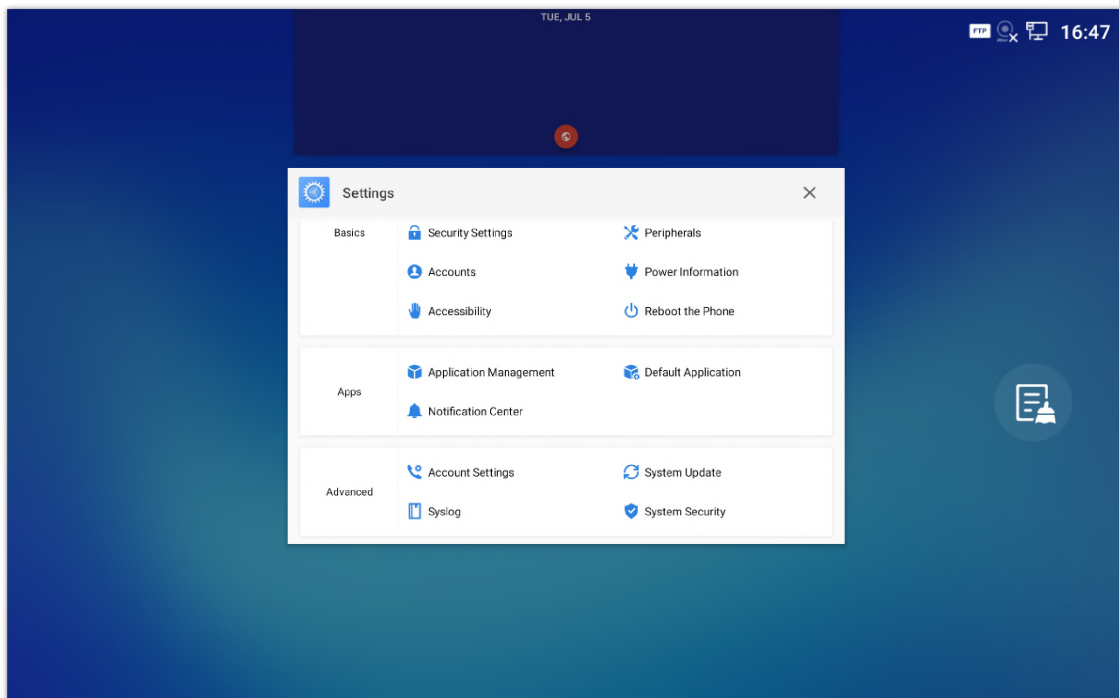



Figure 32: GXV34x0 Recent Applications

Users could use the thread manager to do the following:

- Slide the running thread to the left or right to stop the application.
- Tap on icon  to delete all running threads.
- Tap on "Application" softkey to access application menu for advanced management options.

## Idle Screen

### Switch Idle Screens

The GXV34x0 supports multiple idle screens by sliding the screen horizontally. On the GXV34x0 screen, slightly touch an empty area and slide to the left or right using your finger to switch between different idle screens.

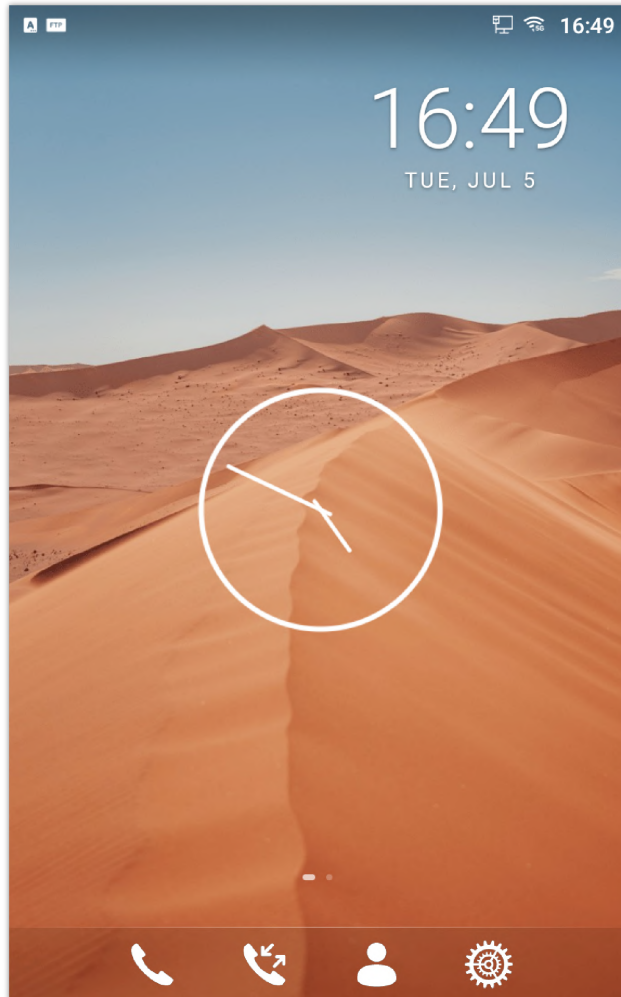





Figure 33: GXV34x0 Switch Idle Screens

### Set Up Idle Screen

- **Set home screen**

Follow the steps below to set up the HOME screen.

1. GXV34x0 is up and running on idle screen.
2. Press the MENU button . This will zoom out all the screens as shown in **[Figure 25: Set up Home Idle Screen]**.
3. The screen with  displayed is the HOME screen. Others are shown with icon . Tap on the icon  to select the corresponding screen as the new HOME screen.

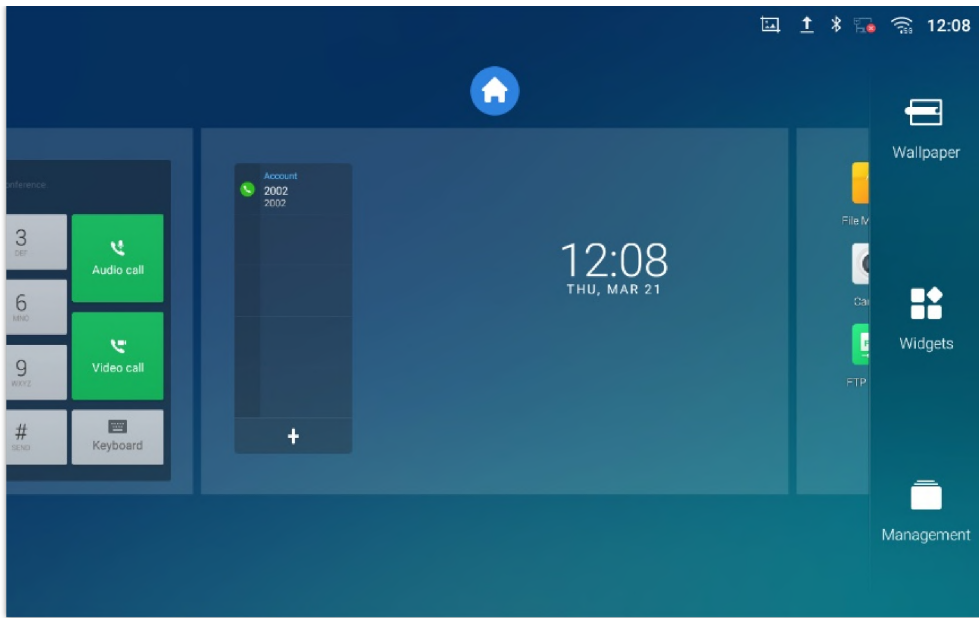

Figure 34: Set up Home Idle Screen

- **Add/Delete idle screen**

As shown in **[Figure 25: Set up Home Idle Screen]**, this section shows the available desktop screens. Users could add or delete idle screen.

- Add idle screen. Tap on  to add a new idle screen.

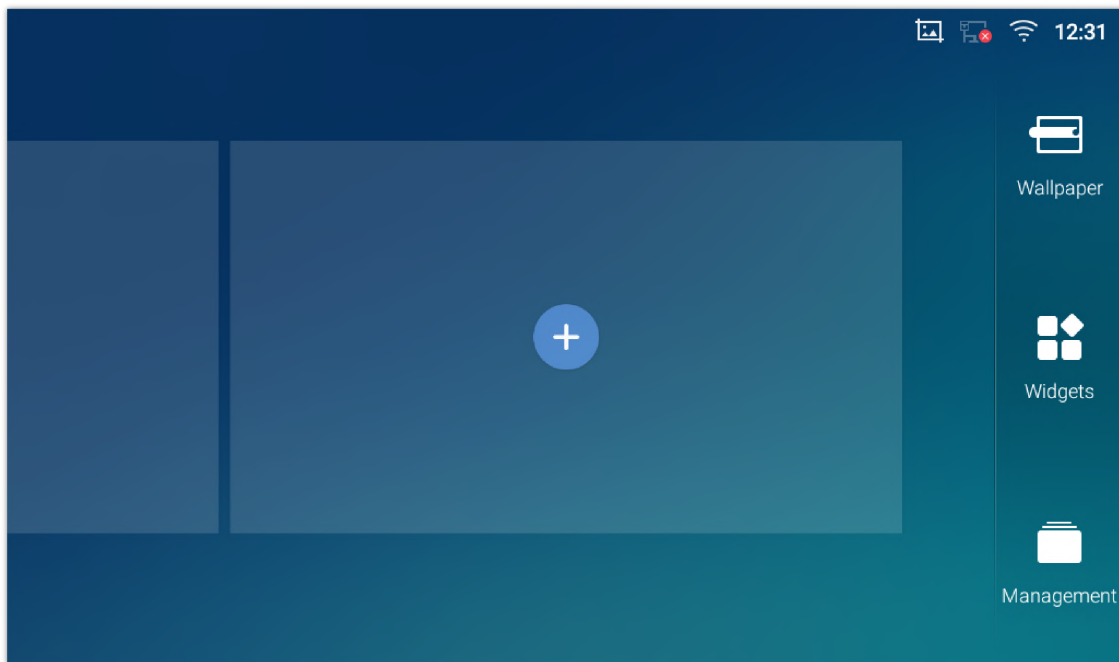



Figure 35: Add an Idle Screen

- Delete idle screen. Tap on  to delete the Idle screen. Please make sure the apps, shortcuts or widgets on the idle screen are removed first. Otherwise, the  icon won't show for the idle screen.

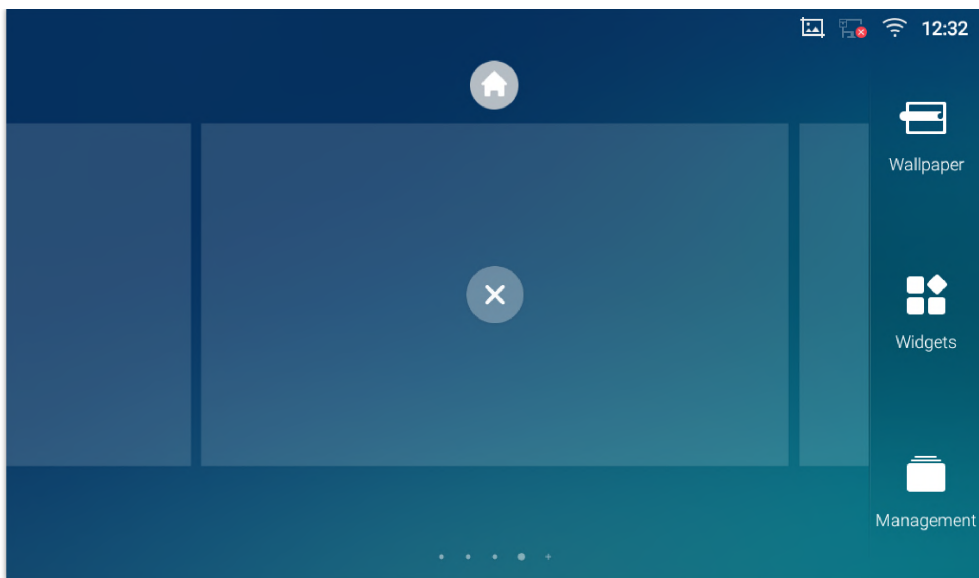

Figure 36: Delete an Idle Screen

## Use the Status Bar

The status bar on the top of the GXV34x0 screen provides visual notifications for the system settings and status, as well as quick access for important system settings. To access it, on the GXV34x0 idle screen, slowly slide down from the top to the bottom of the screen as the following figure shows.

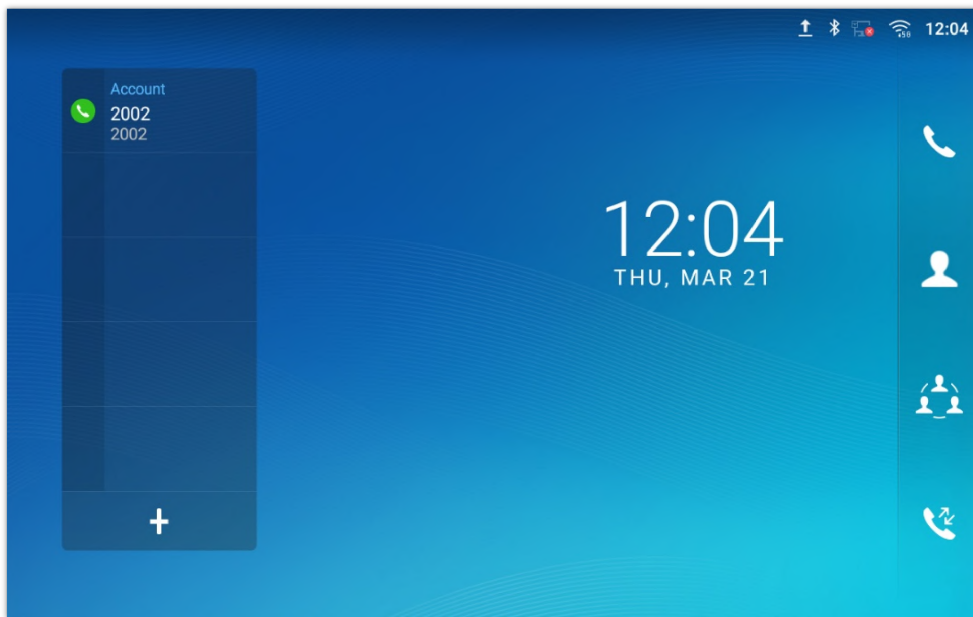

Figure 37: GXV34x0 Top Status Bar

For more options on the Status Bar (brightness, call forward, RJ9 headset...) users can pull down the status bar twice, or once with two fingers.

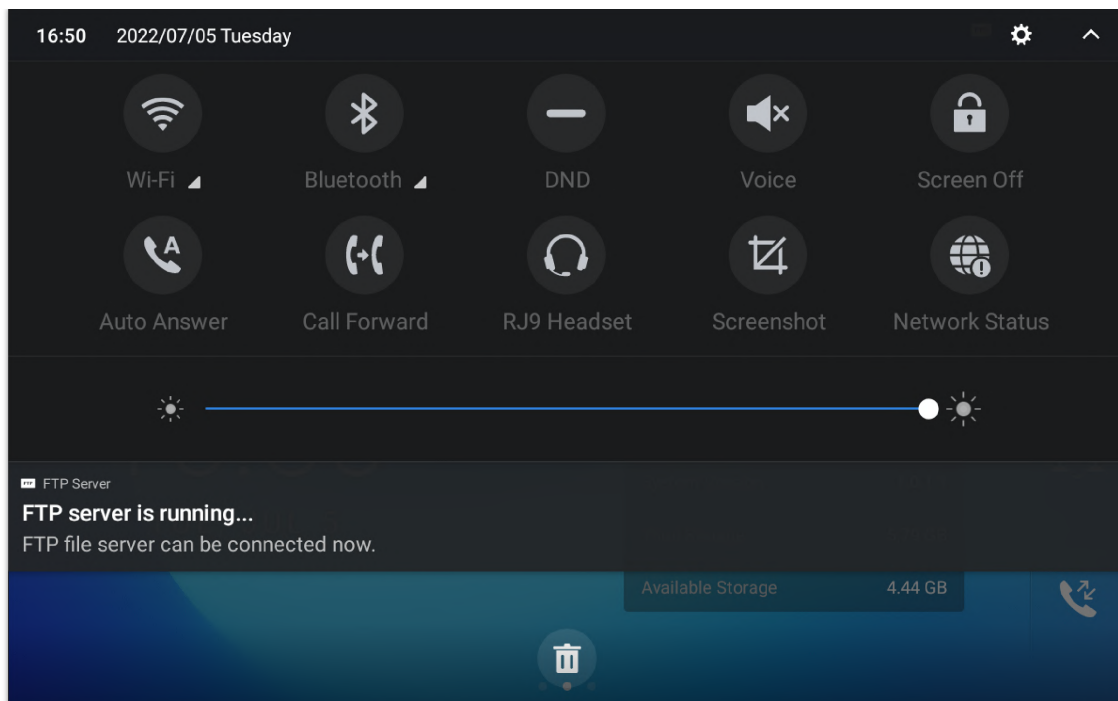

Figure 38: Status Bar – More Options

The running process and notifications will show up in the list.

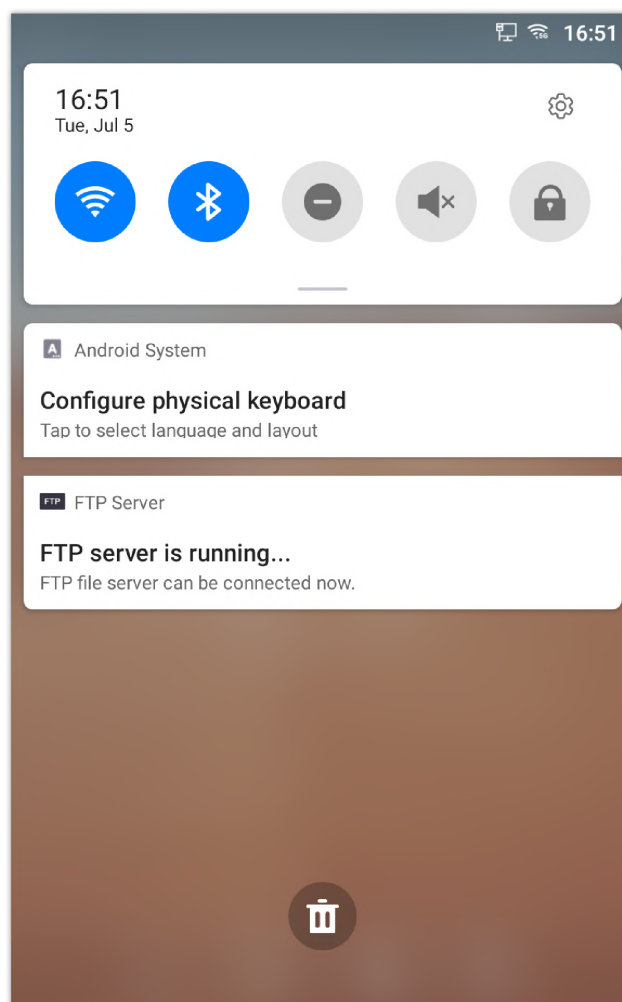

Figure 39: GXV3470 Top Status Bar – Notification

- Tap on the notification message to view the details.
- Slide the notification message to the left or the right side to remove it.

For more information about specific features in the notification bars, you can press the bottom right of the feature in question.

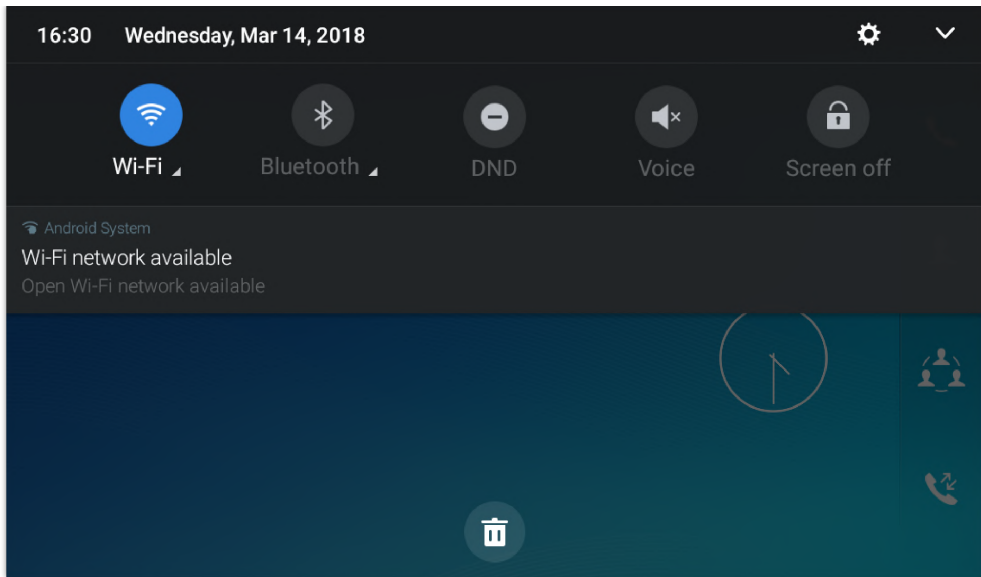

Figure 40: GXV34x0 Top status Bar – Get more information

For example, you can see the available Wi-Fi Networks.

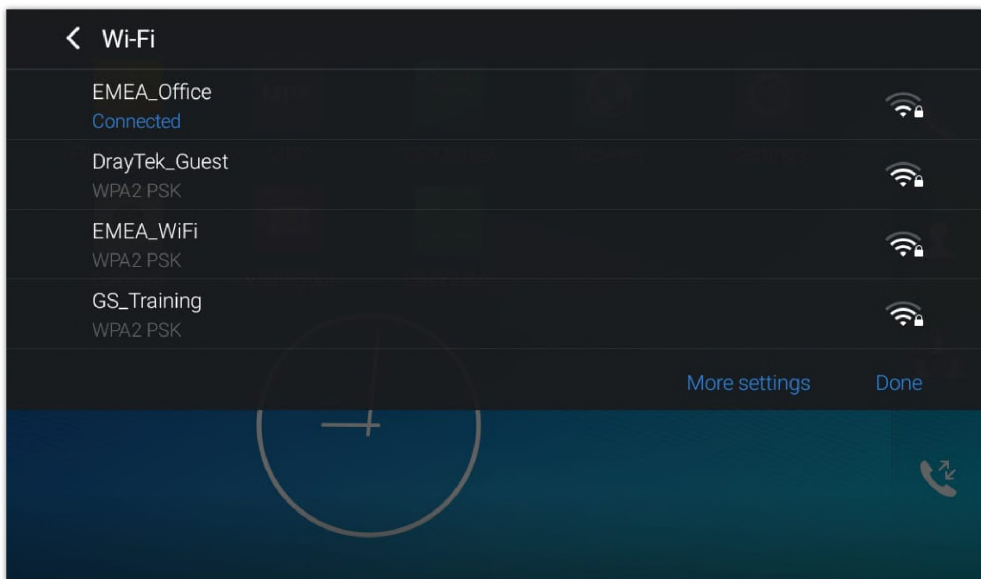























Figure 41: GXV34x0 Top status Bar – Wi-Fi

### Notifications in Status Bar

The following table describes the icons used on the status bar for notification purpose.

	Network connected via Ethernet cable.
	Trying to connect to the network via Ethernet cable.
	Network disconnected via Ethernet cable.
	Handset is off hook.
	Speaker is being used. (x)



	RJ9 headset is connected.
	Wi-Fi is enabled and still not connected.
	3.5mm earphone is connected.
	3.5mm earphone is being used for calls.
	Wi-Fi is enabled and still not connected.
	Wi-Fi network is available.
	Wi-Fi is enabled and connected.
	Onscreen keyboard is activated.
	Bluetooth is enabled but not connected.
	Bluetooth is enabled and connected.
	Bluetooth headset is connected.
	Bluetooth headset is being used for calls.
	Downloading files via Bluetooth.
	Alarm is set up and enabled.
	DND is enabled.
	Silent mode is enabled. When it's on, the incoming call/message won't produce ring tone/notification tone from phone's speaker.















	SD Card is inserted.
	SD Card space full.
	USB flash drive is inserted.
	Downloading files via Internet connection.
	Unread voicemail to be retrieved.
	Incoming call from blacklist contact.
	Camera is disabled.
	Contact storage is full.
	HDMI cable is connected to display device.
	The phone is powered up using PoE.
	Call forward is set up.
	PPPoE is connected.
	PPPoE is not connected.
	Warning message.

Table 17: GXV34x0 Status Bar Notification Icons

## System Settings in Status Bar

Slide down the top status bar and select **System Settings**. Users will see the following settings.

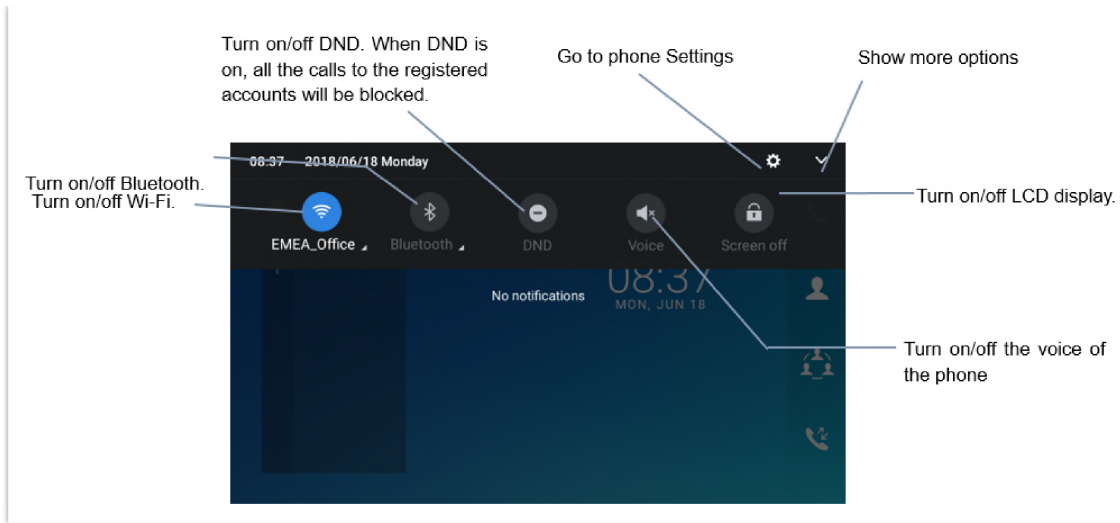

Figure 42: System Settings in Status Bar

## Use the GXV34x0 Keys

- o GXV3480 and GXV3470

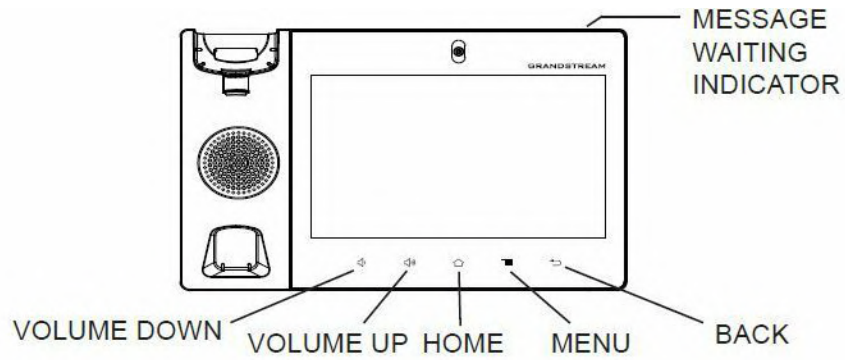

Figure 43: GXV3480 Keys

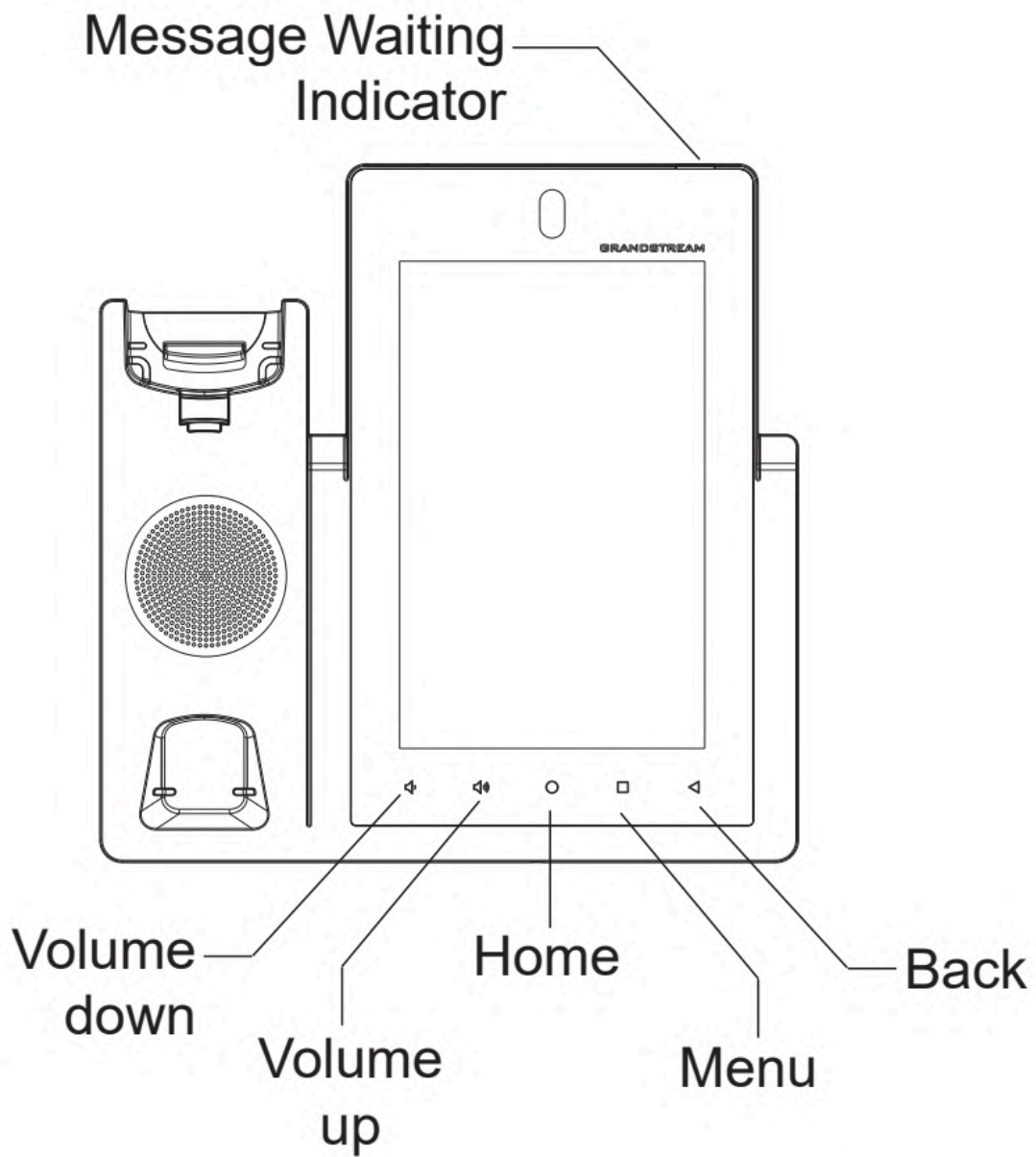

Figure 44: GXV3470 Keys

<b>Volume Down</b>	Tap to turn down the call volume and media volume.
<b>Volume Up</b>	Tap to turn up the call volume and media volume.
<b>Home</b>	Tap to go back to <b>Home</b> screen; or touch and press for about 2 seconds to take a screenshot
<b>Menu</b>	Tap to view options for different screens or applications.
<b>Back</b>	Tap to go back to the previous menu.

Table 18: GXV3480 and GXV3470 Keys

- o GXV3450

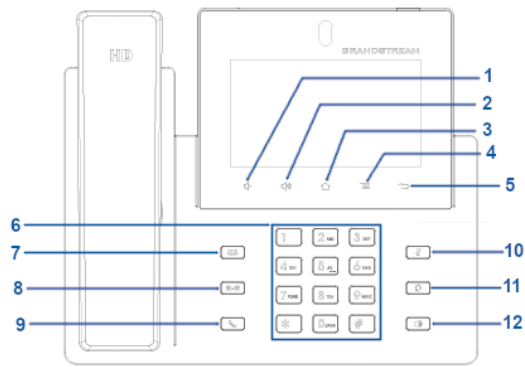

Figure 45: GXV3450 Keys

1	<b>Volume Down</b>	Tap to turn down the call volume and media volume.
2	<b>Volume Up</b>	Tap to turn up the call volume and media volume.
3	<b>Home</b>	Tap to go back to <b>Home</b> screen; or touch and press for about 2 seconds to take a screenshot.
4	<b>Menu</b>	Tap to view options for different screens or applications.
5	<b>Back</b>	Tap to go back to the previous menu.
6	<b>Keypad</b>	Tap to enter numbers or send DTMF
7	<b>Conference</b>	Tap to enter into conference, then make an online meeting
8	<b>Transfer</b>	Transfer the call.
9	<b>Dial/Send</b>	Make a call or send DTMF.
10	<b>Mute</b>	Mute / Unmute the call. Or enable DND when free.
11	<b>Earphone</b>	Tap to enter into the dial interface or switch the media channel to earphone
12	<b>Speaker</b>	Tap to enter into the dial interface or switch the media channel to speaker

Table 19: GXV3450 Keys

## Keypad Shortcut Functions

The GXV34x0 supports keys shortcuts for certain special system functions.

- **Screenshot**

Press and hold the Home button  for about 2 seconds to capture screenshot. The screenshot can be accessed via **File Manager** → **Pictures**.

- **Upgrade via USB flash drive**

**Step 1:** Plug in USB flash drive into your PC USB (Type-A) port. Download the firmware file to PC and save it in the root directory of USB flash drive.

**Note:**

- You can copy firmware to different USB flash drives. Multiple GXV340 upgrades can be performed simultaneously.
- Please make sure the firmware filename is **gxv3480fw.bin, gxv3470fw.bin or gxv3450fw.bin**.

**Step 2:** Remove the USB flash drive from the PC and insert it to GXV34X0 USB (Type-A) Port.

**Step 3:** Wait for a moment, GXV34X0 will automatically detects the current version and the new version. Following pop-up window will displayed on LCD screen.

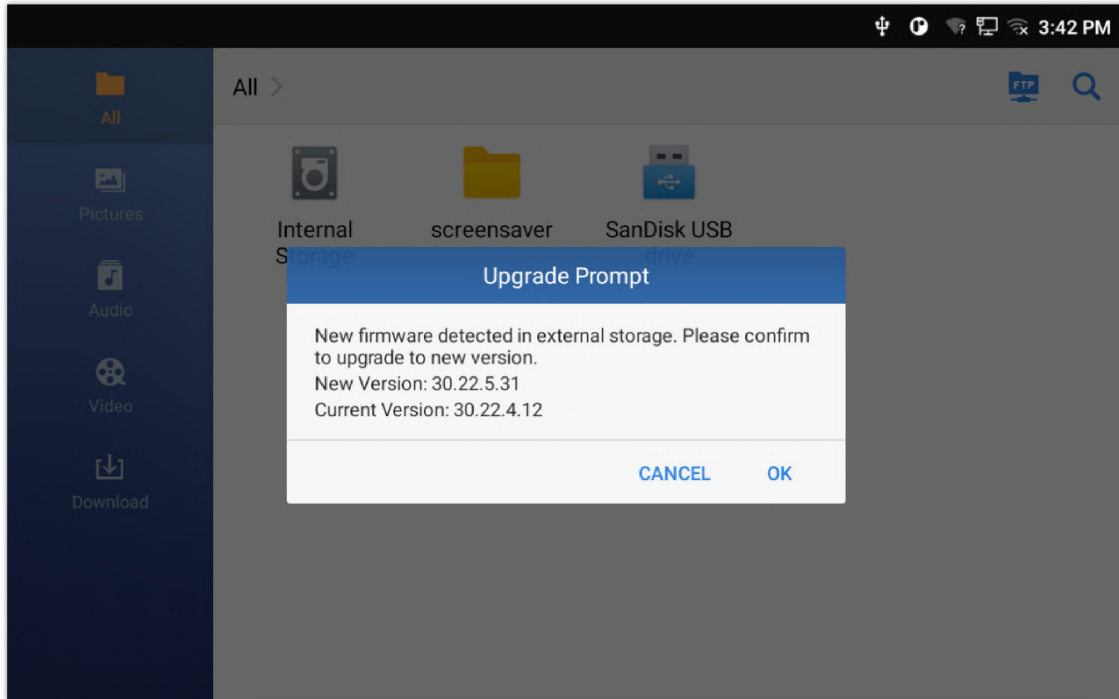

Figure 46: Upgrade Prompt

**Step 4:** Click "OK", the device will perform upgrade automatically. This process will takes about 3 minutes.

**Note:** When prompted by this screen, ensure that the USB flash drive is inserted into the device.

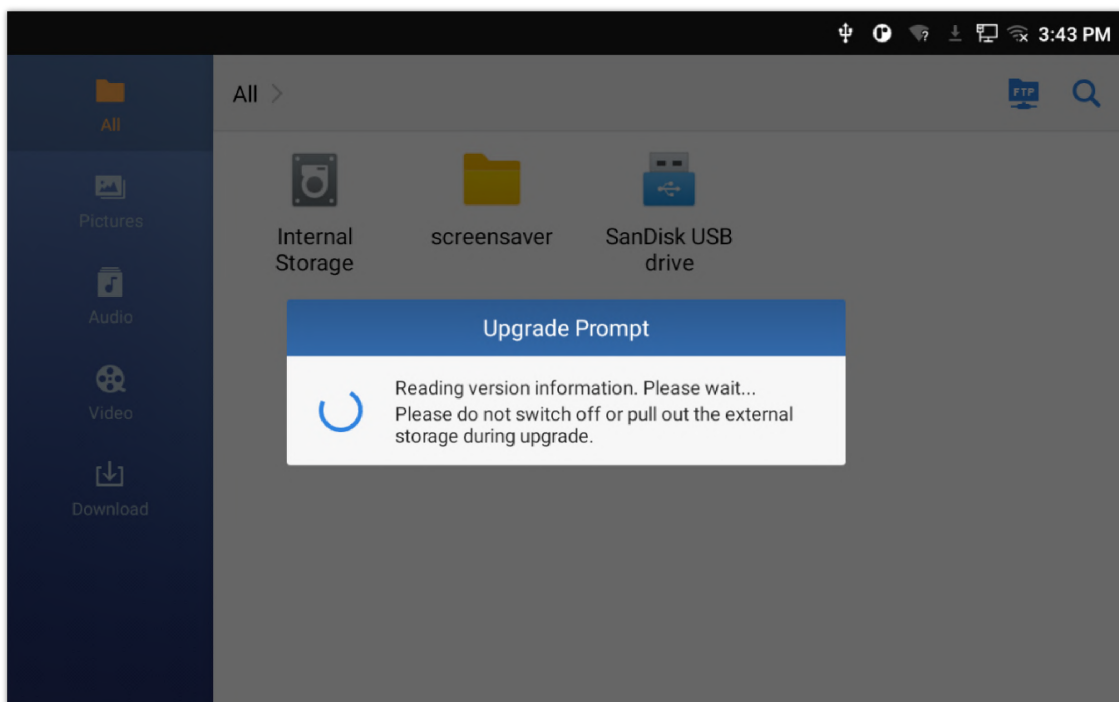

Figure 47: Reading version information

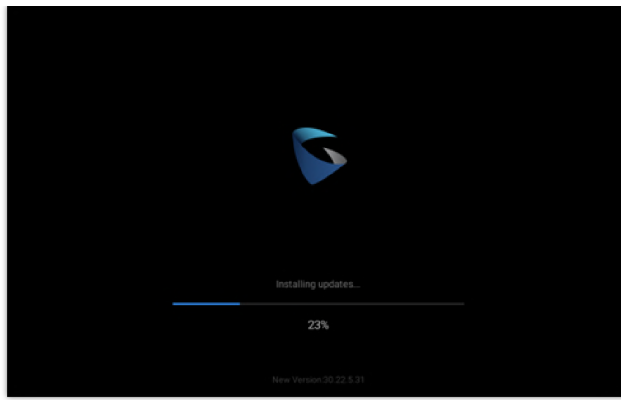

Figure 48: Installing Firmware

**Step 5:** Wait until the upgrading is done. The GXV34X0 will reboot itself. Go to **Settings ->Status->System Info** to check the firmware current version.

- o **Hard reset**

For users that want to factory reset the device manually, hard reset is an alternative:

1. Power cycle the GXV34x0.
2. Wait for the LED in the upper right of the phone to light up in Green, then about 2 seconds, press the both keys **⏮**+ (the second LCD key from the left: Volume Up) and **≡** (the 4th LCD key from the left : Menu) at the same time, it will go into the factory reset process.
3. The LCD screen will display "Factory reset, please wait".
4. The GXV34x0 will reboot with factory default settings.

## Use the On-Screen Keyboard

The GXV34x0 onscreen keyboard can be activated by tapping on an input field.

- o **English Keyboard**

This is the default keyboard on GXV34x0.

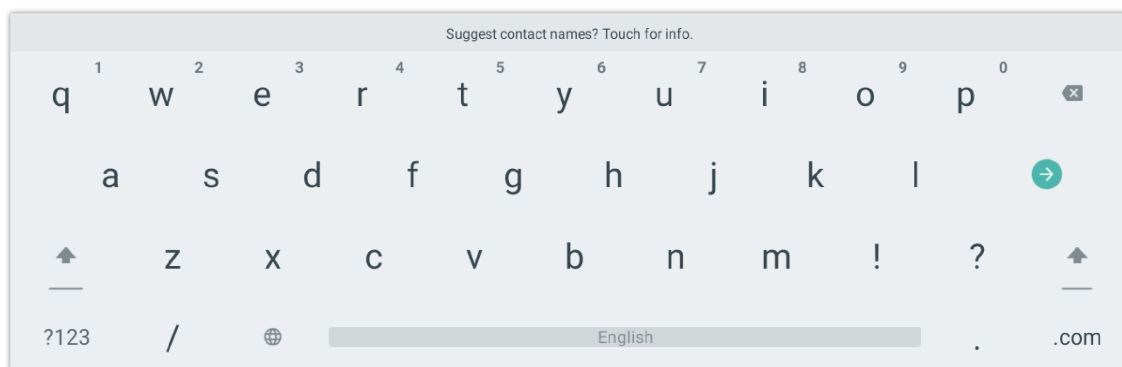

Figure 49: GXV34x0 Onscreen Keyboard – English Keyboard

To switch input between lowercase and uppercase, tap on **⏮** (lowercase) or **⏭** (uppercase).

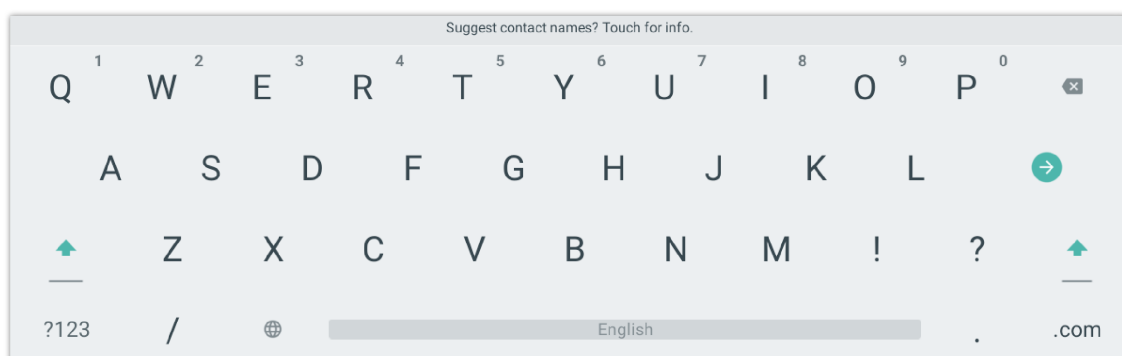



Figure 50: GXV34x0 Onscreen Keyboard – Lowercase and Uppercase

o **Number and symbols**

To input number and symbols, tap **?123** on the default keyboard to switch to number/symbols. Tap on **ABC** to switch back.

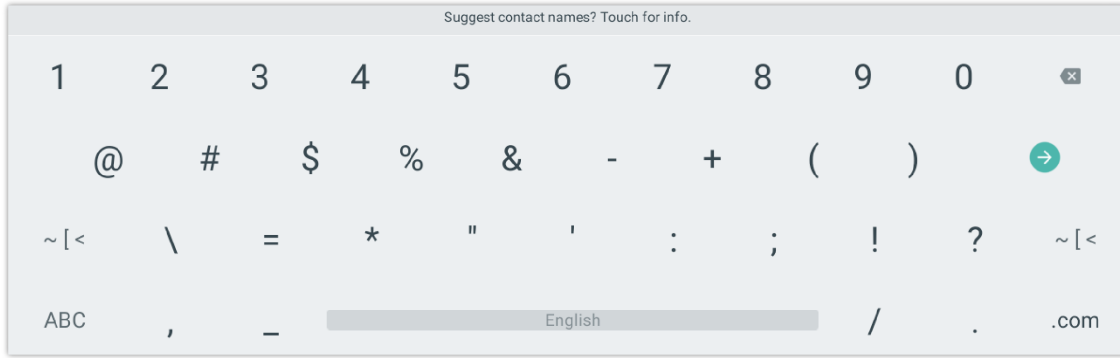

Figure 51: English Keyboard – Number and Symbols

Tap on **~[<** to access more symbols.

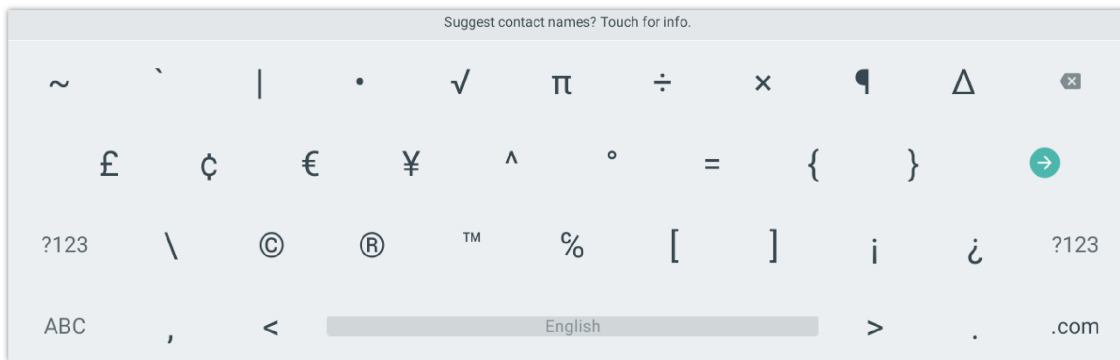



Figure 52: English Keyboard – More Symbols

**Note**

- o To configure keyboard and input methods options, please refer to the following steps:
  1. Go to **Settings→Basics→Language & Keyboard→On-screen keyboard**
  2. Click on “+” to add more input method.
  3. Go to **Settings→Language & Keyboard→Current Keyboard**, and choose from the input methods.
  4. After these steps, the method would change to the new one.
- o Users could touch and press the key on the keyboard for about 2 seconds to input the alternative character. For example, touch and press the “+” key for about 2 seconds can get the selection “±”.

**Use the Message Waiting Indicator**

The GXV34x0 message waiting indicator LED is on the upper right corner of the device. It could notify the users with different messages and status of the phone. Please refer to the status description below. **The priority for the LED indicator is from high to low in the following table.**

Color	LED Status	Description
	Fast Flashing	Incoming call
	Solid	Calling, Talking, Conferencing, Screensaver on when the LCD is off





	Slow Flashing	A call is on hold
	Flashing	Missed call (s), New voicemail (s), New SIP Message (s)
	Solid	High memory usage, Maximum contact storage, Network disconnect
	Fast Flashing	Upgrading
OFF	OFF	Normal

Table 20: GXV34x0 MWI LED Status

## MAKE PHONE CALLS

### Register SIP Accounts

The GXV34x0 supports up to 16 independent SIP accounts. Each account can have separate SIP servers, usernames and NAT configurations.

### Account Status

On the idle screen, the account widget shows the account name, and registration status.

- The following figure shows the account is successfully registered (account icon is green).
- If the account icon is grey, it's still trying to register or unable to register.

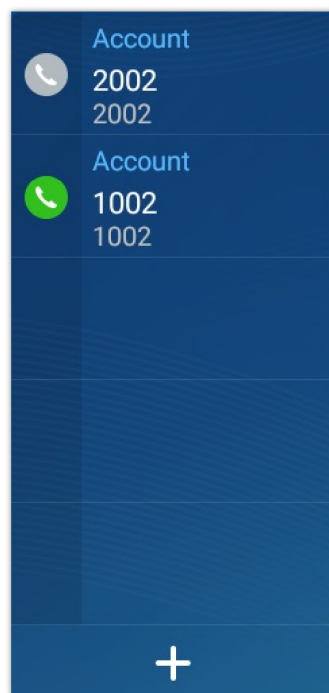

Figure 53: GXV34x0 Account Widget

### Configure SIP Account

To register a SIP account, users can access phone's LCD menu → **Settings** → **Advanced** → **Account Settings**

Or users could log in the GXV34x0 web GUI → **Account** → **SIP page** to fill in the necessary registration information, i.e., Account active, Account name, SIP Server, SIP User ID, SIP Authentic ID, SIP Authentic Password, etc. Once the correct information is entered and saved, the account registration status will show on the main screen.

## Note

For web GUI login and configuration information, please refer to GXV34x0 Administration Guide.

If the account is successfully registered, users could use one of the following ways to bring up dial screen to start making calls.

- Take the handset off hook.
- Select an account from the account widget in the idle screen.
- On the shortcuts menu of the idle screen, tap on  icon to open dial screen.

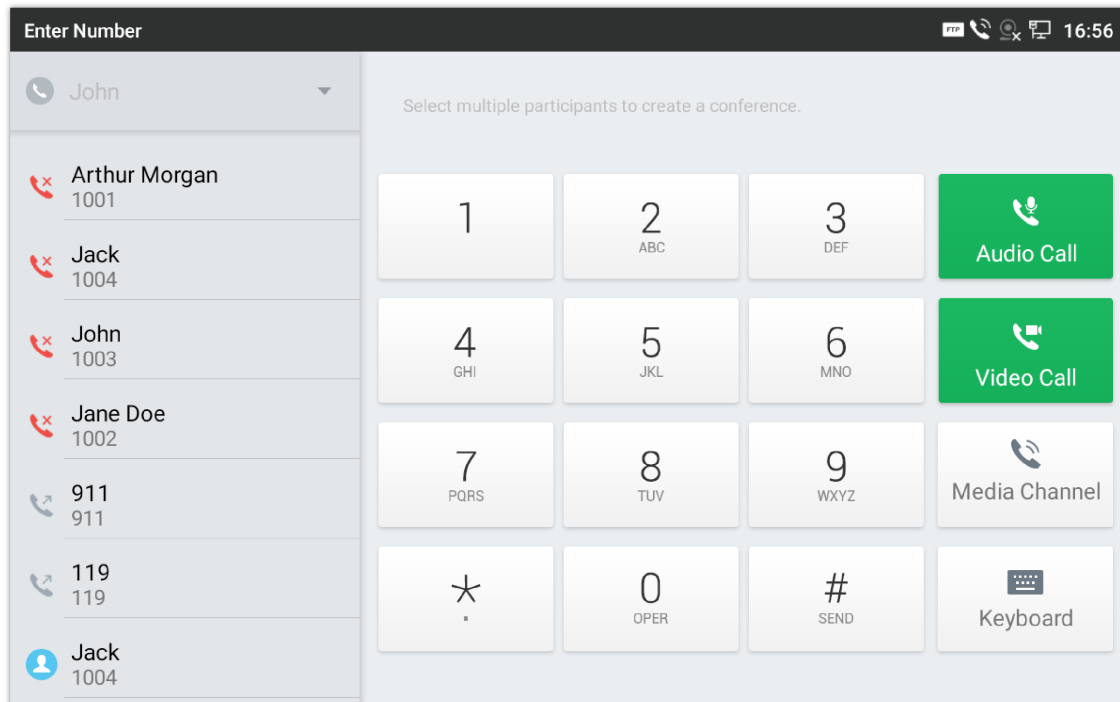

Figure 54: GXV34x0 Dial Screen

**Note:** If **Enable Video Call** option is unchecked, the **Video Call** option on GXV34x0 dial screen won't be available.

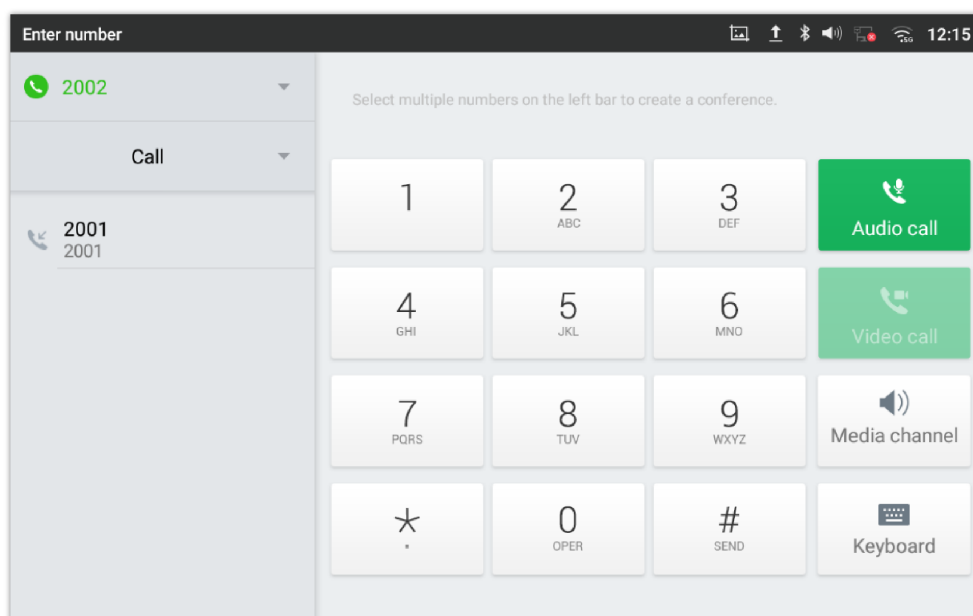



Figure 55: Disable Video Call Feature on Dial Screen

## Dial a Number Directly

1. Use the methods mentioned above to open dial screen [Figure 40: GXV34x0 Dial Screen].
2. Select the account to dial out on the left panel of the dial screen. The selected account will be displayed in green

3. Enter the digits to be dialed out using the keypad. If the digit matches call history, a list of numbers will be displayed for users to select from.
4. Tap on  (audio call only) or  (video call) to send the number. If no key is pressed, by default the call will be automatically dialed out after 4 seconds timeout.

#### Note

- By default, the “No Key Entry Timeout” is 4 seconds, meaning if no key is pressed after entering a number, the call will be automatically sent out after the timeout. The timeout interval can be configured under web GUI→**Account**→**Call Settings**.
- GXV34x0 allows users to press # key as SEND key. This behavior can be disabled via option “Use # as Dial Key” under web GUI→**Account**→**Call Settings**.
- When the user enters the digit on the dial screen, if there is digit matching call history, or contacts name/number, the drop-down list will show the numbers. For example, if “John” is saved in the contacts, entering 5 (JKL) 6 (MNO) 4 (GHI) 6 (MNO) will show call log with 5646 as the first four digits, as well as John’s number. Users could then directly select one of them from the list, instead of entering all the digits.



## Redial

Users can dial out the last dialed number if there is dialed call log, using the same SIP account making the call last time.

1. Enter the dial screen.
2. A list of dialed calls will be displayed on the left side of the dial pad. Tap on the number you would like to call, the number will be added to the dialing field, press Audio call or Video call to redial.

## Dial a Number via Contact

Follow the steps below to dial a number via Contact.

1. Access Contacts by tapping on  icon on the left side of the idle screen.
2. Navigate in the contacts entries by sliding up/down on the screen.
3. Tap on the dial icon for the contact 

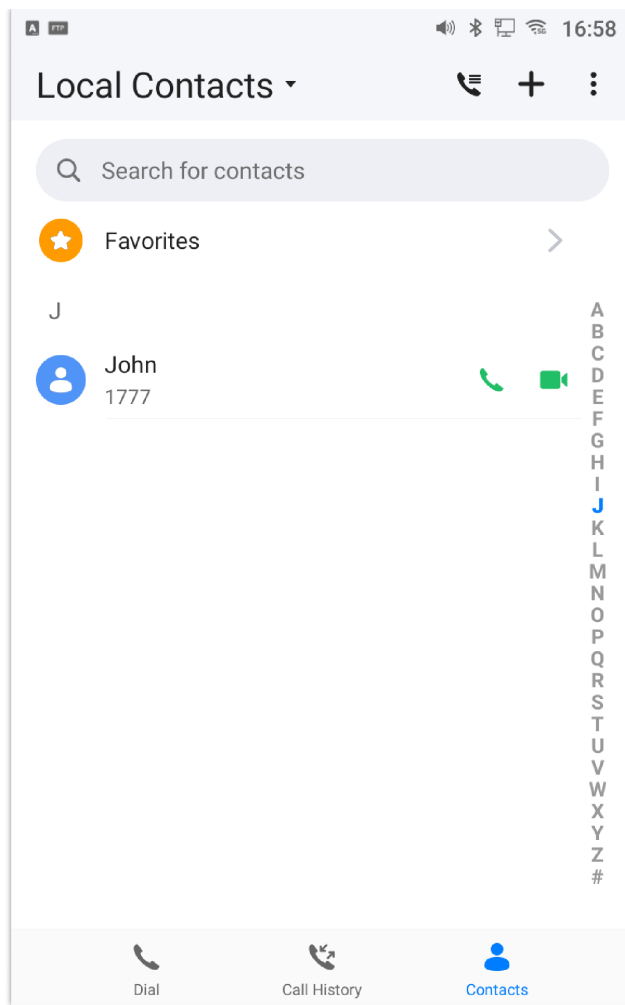







Figure 56: GXV34x0 View Contacts

## Dial a Number via Call History

1. Access Call History by tapping on  icon on the bottom of the idle screen.
2. The LCD will display all call history types: "All", "Missed", "Outgoing" and "Incoming" calls.
3. Navigate in the call history list by selecting the call history category and sliding up/down on the screen.
4. Tap on the entry to show more details or tap on  or  to dial out.

**Note:** The icon next each call indicates the Call Type with which the call was made, icon  means this was a Video call.  
And  means it was an Audio call

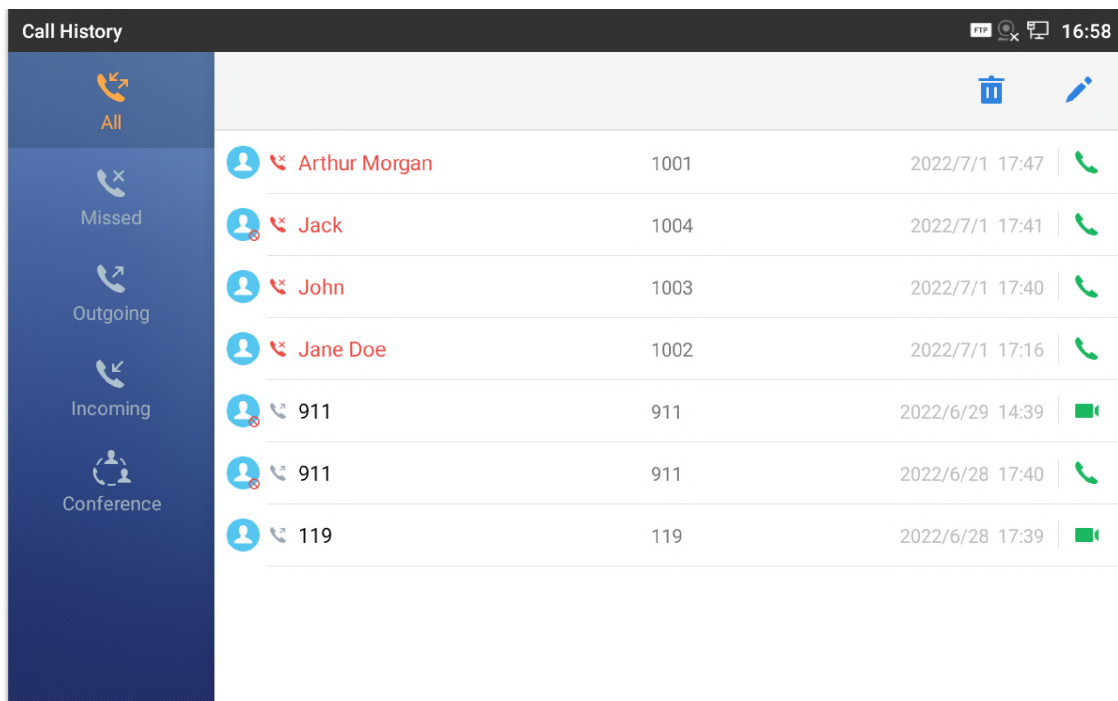

Figure 57: GXV34x0 Call History

In order to select which call mode to use when calling from Call History, access the call Details, then press the icon with keypad to dial the number on the phone's keypad directly and then select whether to use Audio or Video Call to begin the call

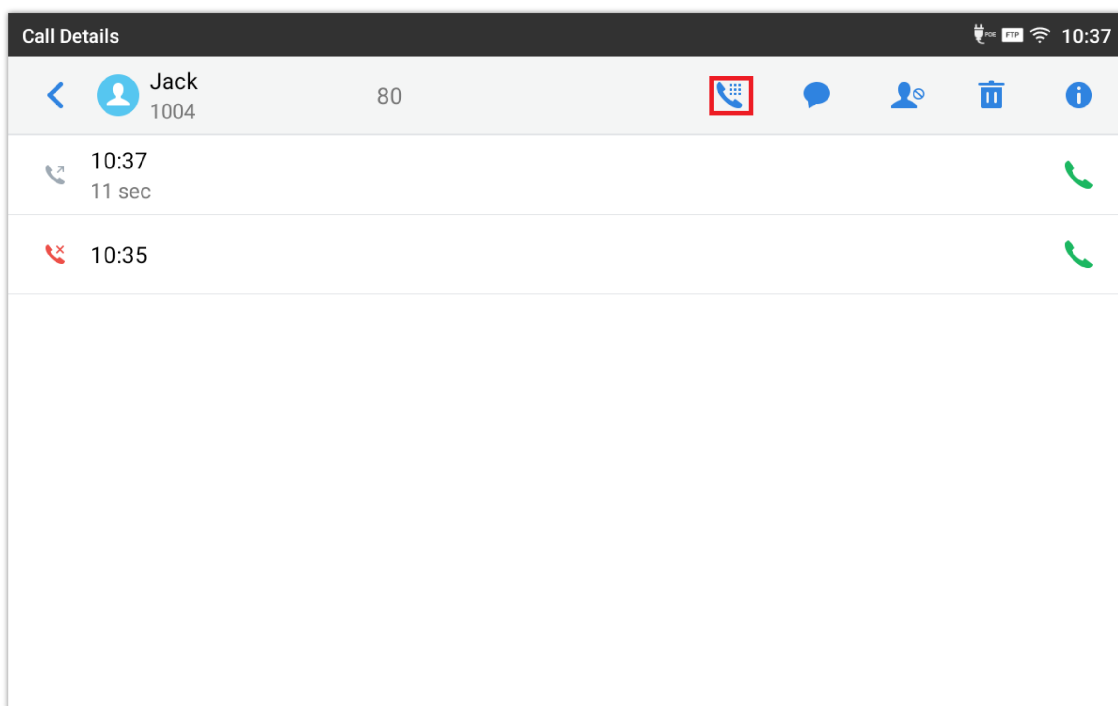

Figure 58: Choose Call mode from call history

## Answer a Call

### Single Incoming Call

- When the phone is in idle and there is an incoming audio call, the phone will show the call screen as below. Tap on "Answer" softkey to answer the call via speaker or pick up the handset the answer the call.



Figure 59: Single Incoming Call – Audio

- When the phone is in idle and there is an incoming video call, the phone will show the call screen as below. To answer the call with audio only, tap on "Audio" to answer the call via speaker. To answer the call with both audio and video, tap on "Video". During video call or pick up the handset, the audio will switch to handset if picking up the handset.

**Note**

Users could select the **Video Display Mode** on phone's Web UI→**Phone Settings**→**Video Settings**. Set the video display mode to "**Original proportion**", "**Cut proportionally**" or "**Add black margin proportionally**".

If set to "**Original proportion**", the phone displays video in its original proportion. If the video display proportion is different from the one of the phones, the phone will stretch or compress video to display it. If set to "**Cut proportionally**", the phone will cut video to meet its own display proportion. If set to "**Add black margin proportionally**", the phone will display video in its original proportion, if still exists spare space, the phone will add black edge on it.



Figure 60: Single Incoming Call – Video

- If the phone set the "Preview" feature for the incoming call from Web UI, the phone will display one more key "Preview" when there is an incoming video call. End users will preview the remote end without answering the video call. After previewing, end user can tap on Answer key to answer the video call, or "Reject" key to reject it. This feature should be supported by the SIP server. Please contact service provider for more information.





Figure 61: Single Incoming Call – Preview-1

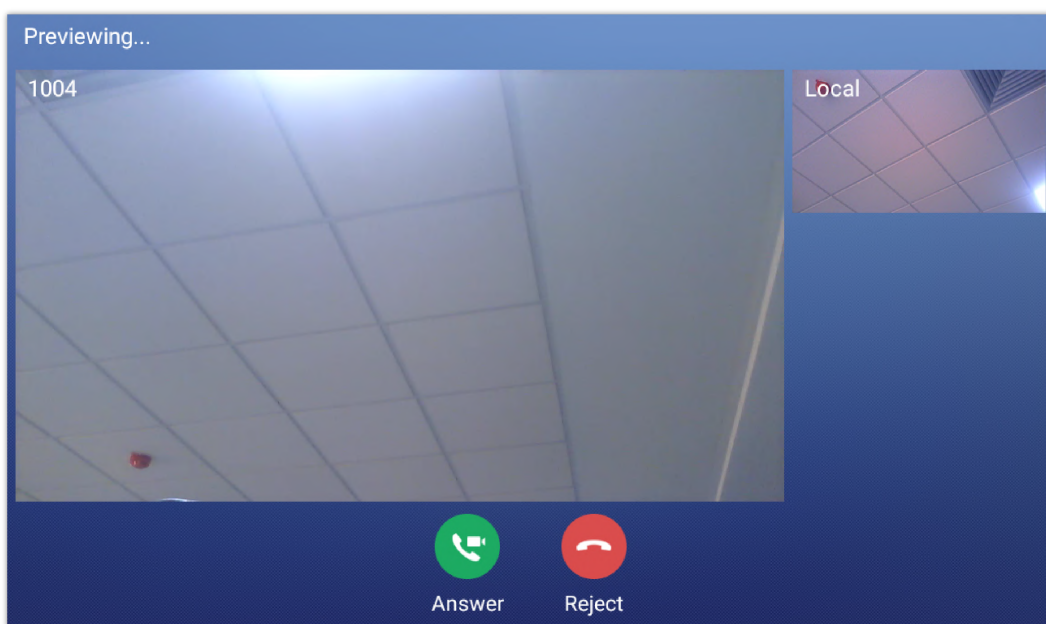

Figure 62: Single Incoming Call – Preview-2

### Transfer Function for Incoming Call

- o If the phone set the "Transfer" feature for the incoming call from Web UI, the phone will display one more key "Transfer" when there is an incoming call. End users will have the possibility to transfer the call without answering. After pressing "Transfer" button, end user can enter manually destination or press "MPK" to select a destination. "Reject" key to reject it. This feature should be supported by the SIP server. Please contact service provider for more information.

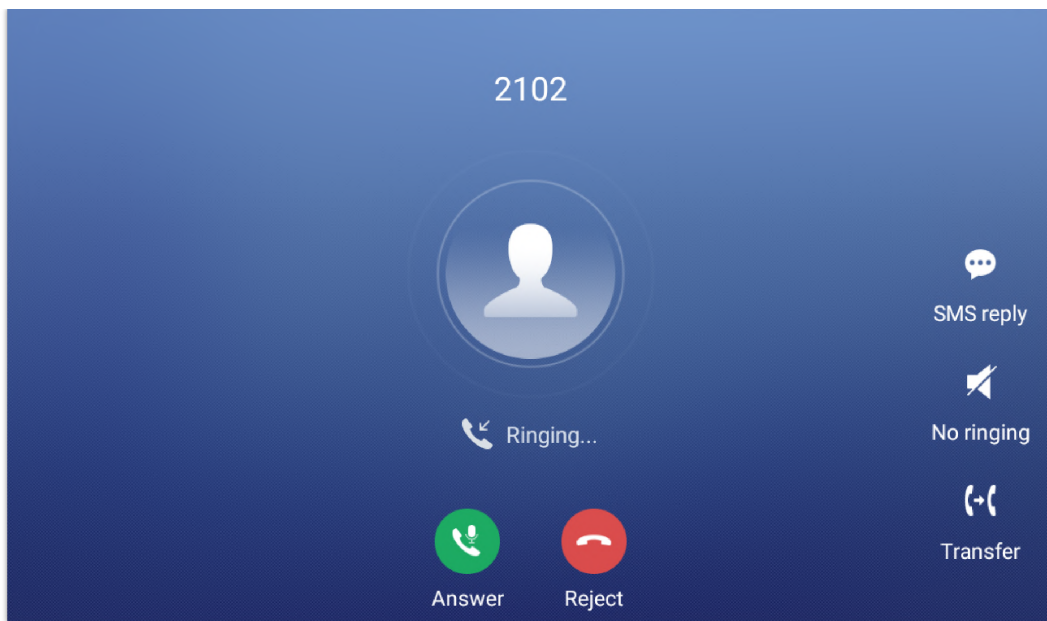

Figure 63: Single Incoming Call – Transfer - 1

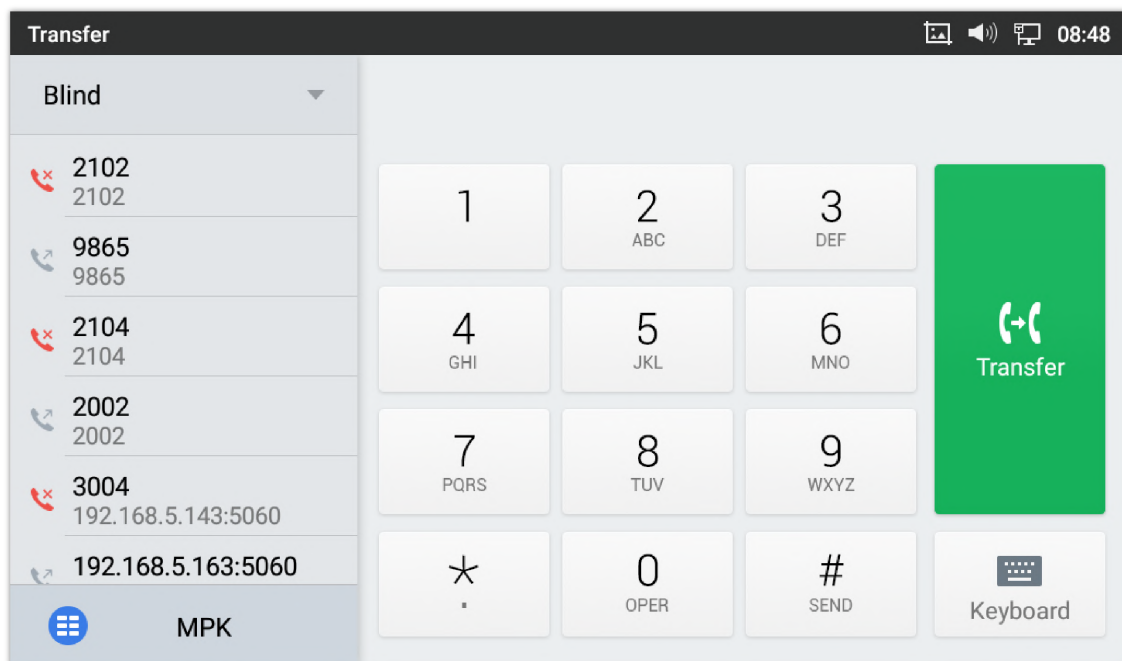

Figure 64: Single incoming Call – Transfer – 2

## Multiple Calls/Call Waiting

1. When there is another incoming call during active call, users will hear a call waiting tone, with the LCD displaying the caller name and ID for the incoming call. In the prompt window, it shows new incoming call from "Jack" with the caller number; the account bar in purple is the current active call with "1004".

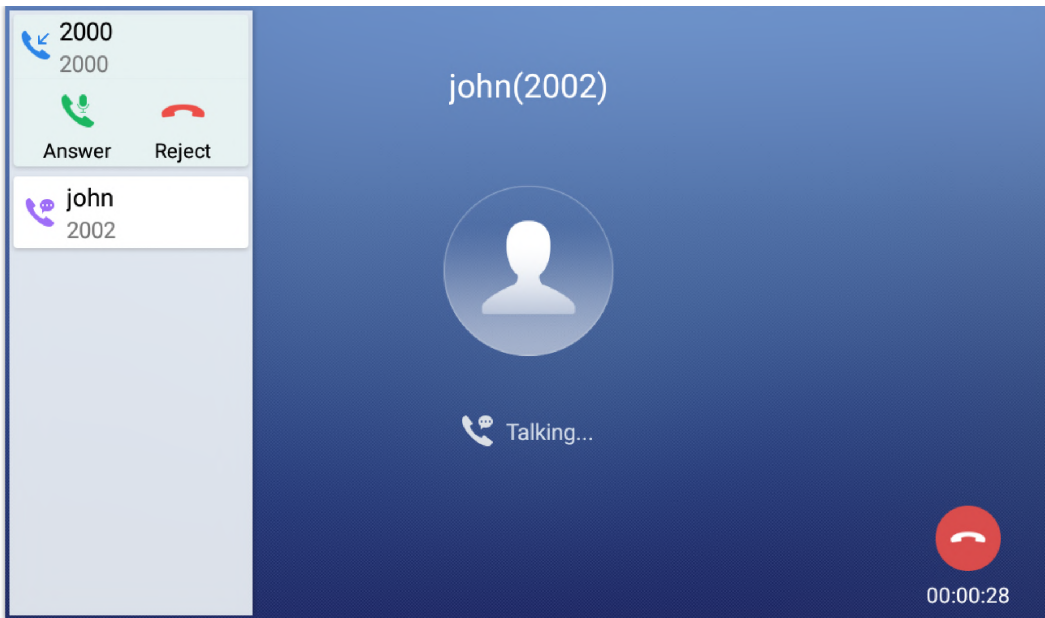
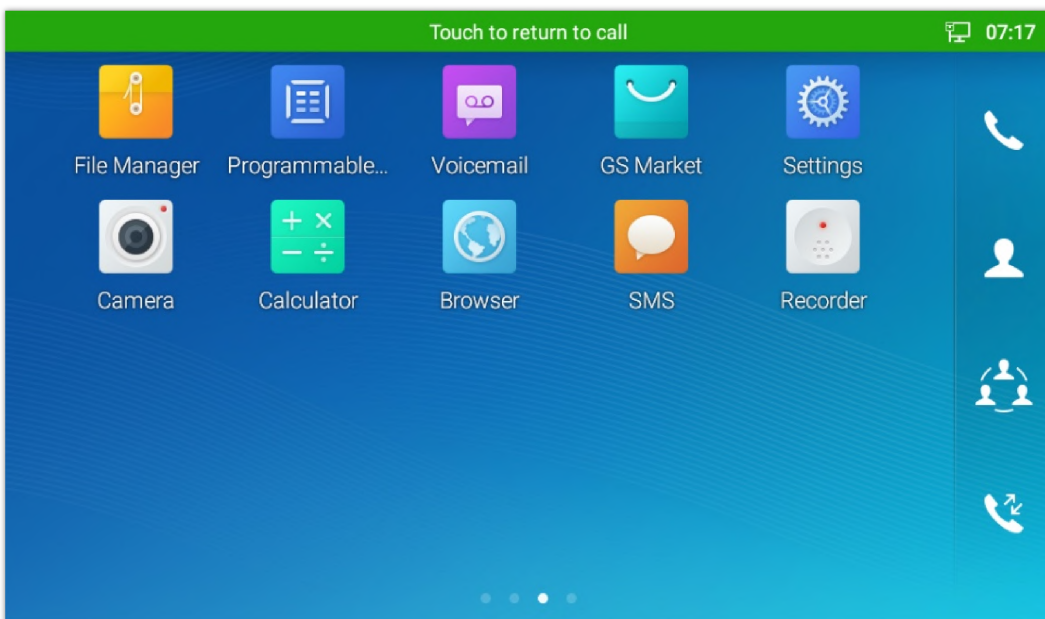

Figure 65: Call Waiting

2. Similar to single incoming call, if the incoming call is video call, users can choose to Audio Answer or to Video Answer
3. Once the new call is answered, the current active call will be placed on hold. If the new call is rejected by tapping on "Reject" softkey, the current active call will not be interrupted.

### Call Progress Status

During an active call if Home Button is pressed, the phone will go back to the home screen and the call-in-progress status will be shown on the GXV34x0 status bar, once clicking the bar it will go back to call screen.



Touch to Return to Call Screen

### Call Switch

This feature allows the user to switch an ongoing call between different devices or apps.

When the user answers a call from a different source such as Wave app on a PC or cellphone, the LCD would display a notification on the top of the GXV34xx to allow to switch the call to that device.



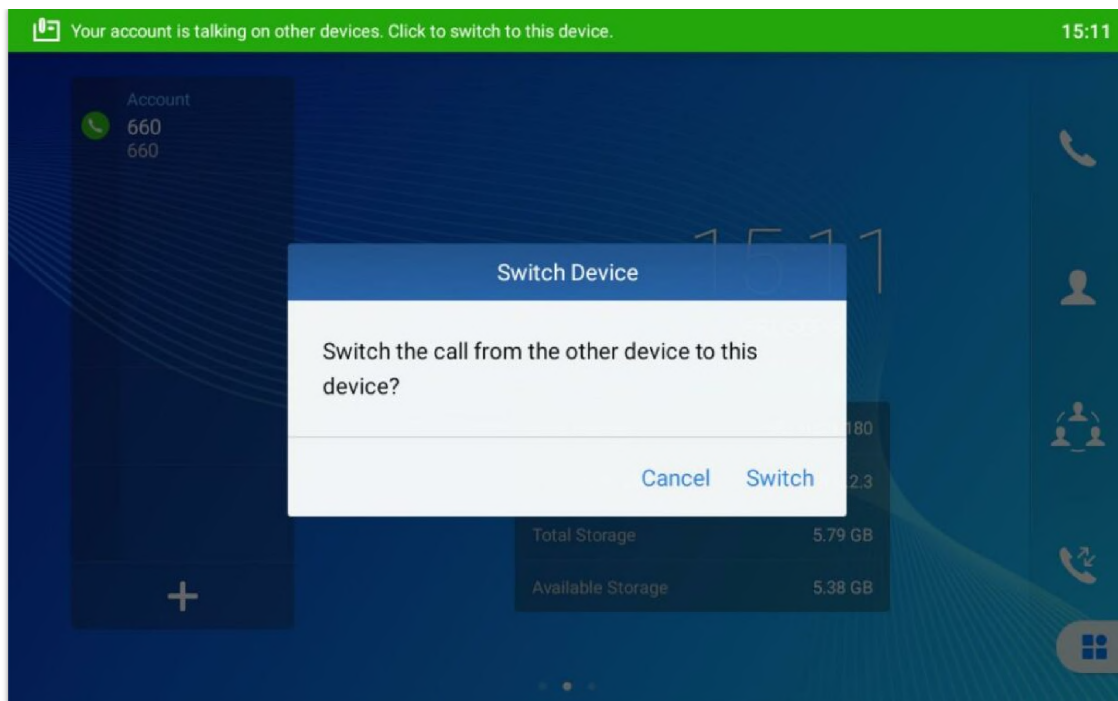

Call switch interface

## Call Hold

During the active call, press HOLD softkey under **"More"** → **"Hold"**. The LCD screen will show as below. To resume the call, press UNHOLD softkey on the bottom of the screen.

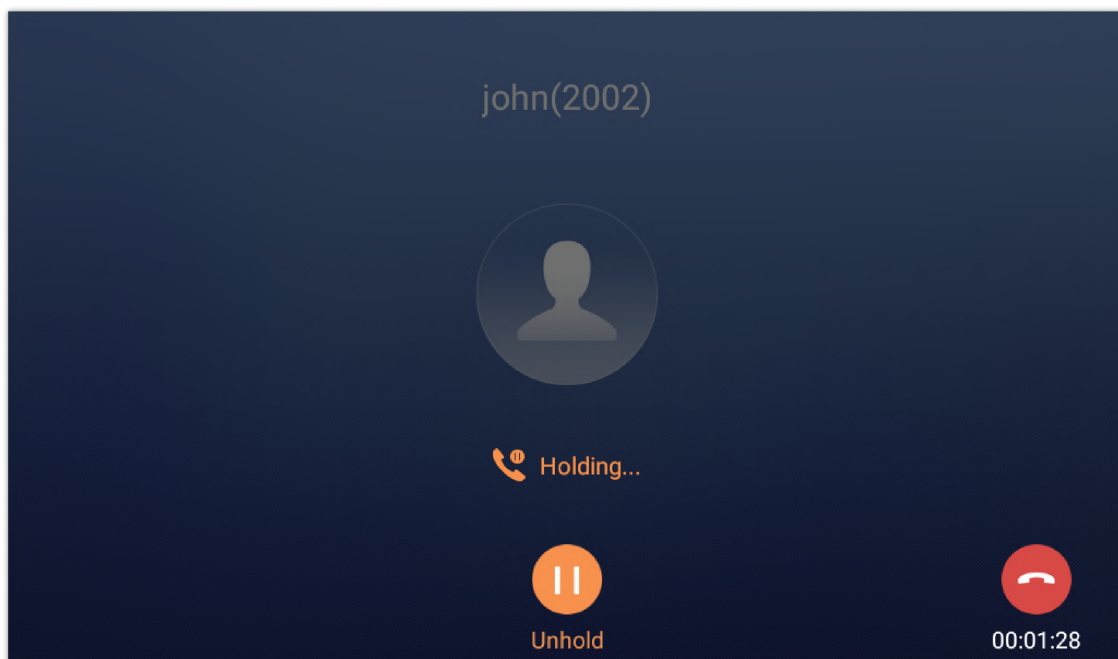

Figure 67: Call on Hold

## Call Recording

1. During the call, users could record the conversation to the phone by tapping on **"More → Record"**
2. If need to stop the recording, tap on **"Stop Recording"**
3. The recording files can be retrieved from the GXV34x0 **"Recorder application"**

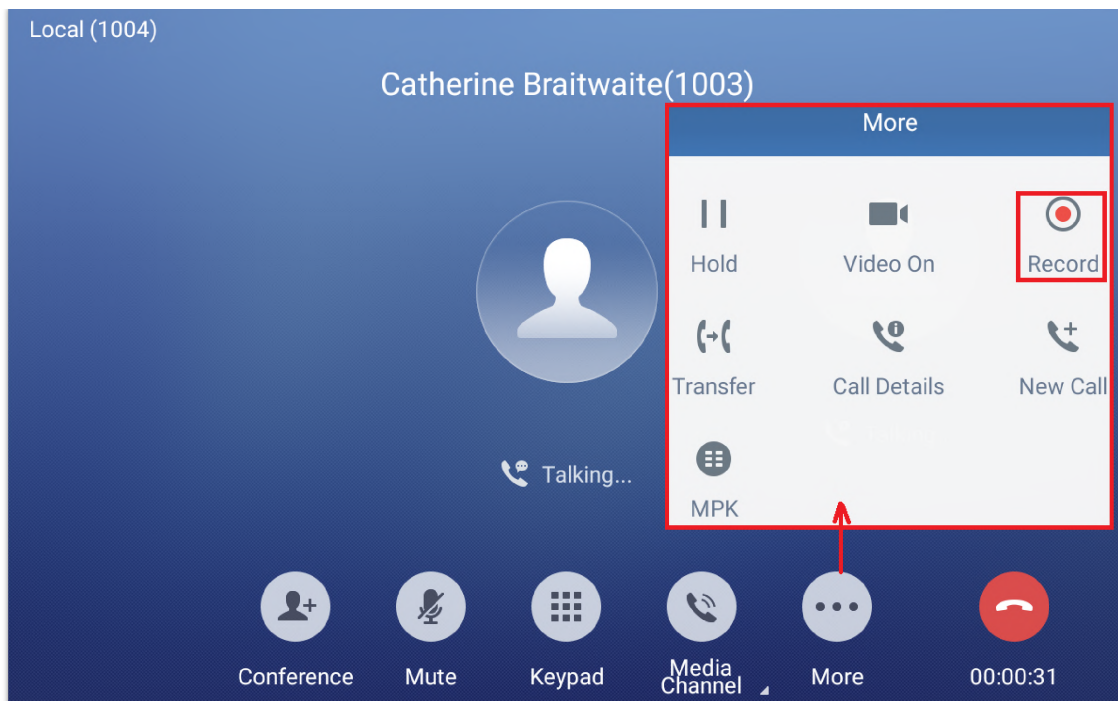

Figure 68: GXV34x0 Call Recording

## MPK Monitoring

During the call, users could view and monitor the programmable keys configured for the current Account:

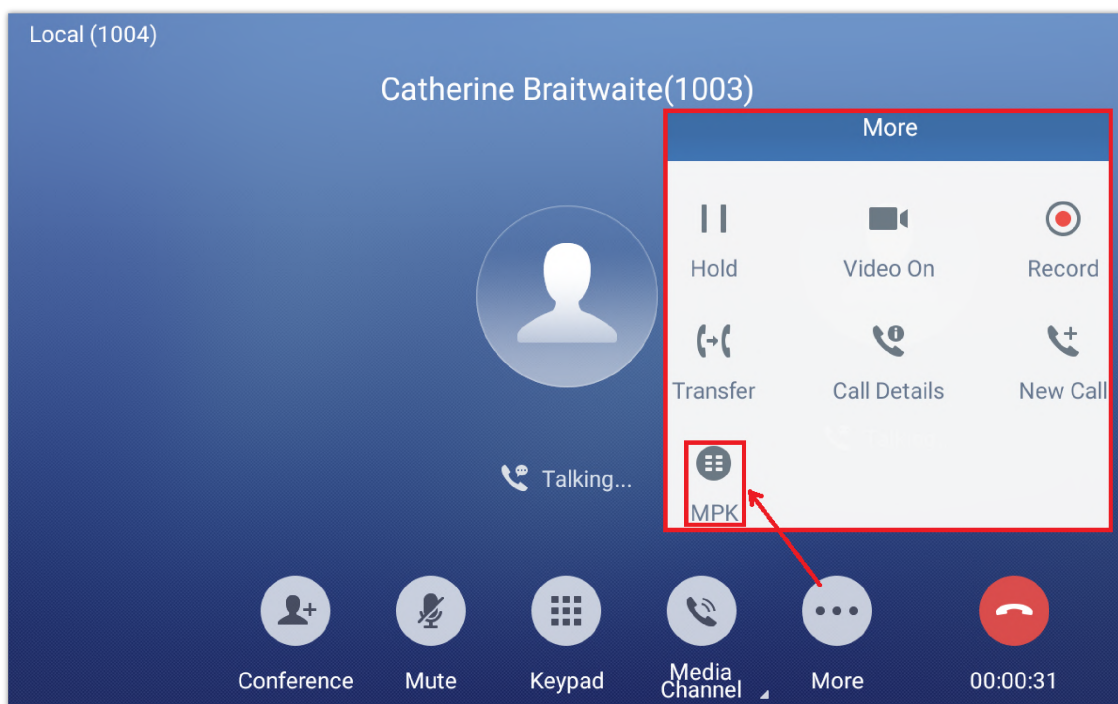

Figure 69: MPK button

1. During the Call, press "**More** → **MPK**" button as shown above.
2. The list of MPK configured for the active account will be displayed.

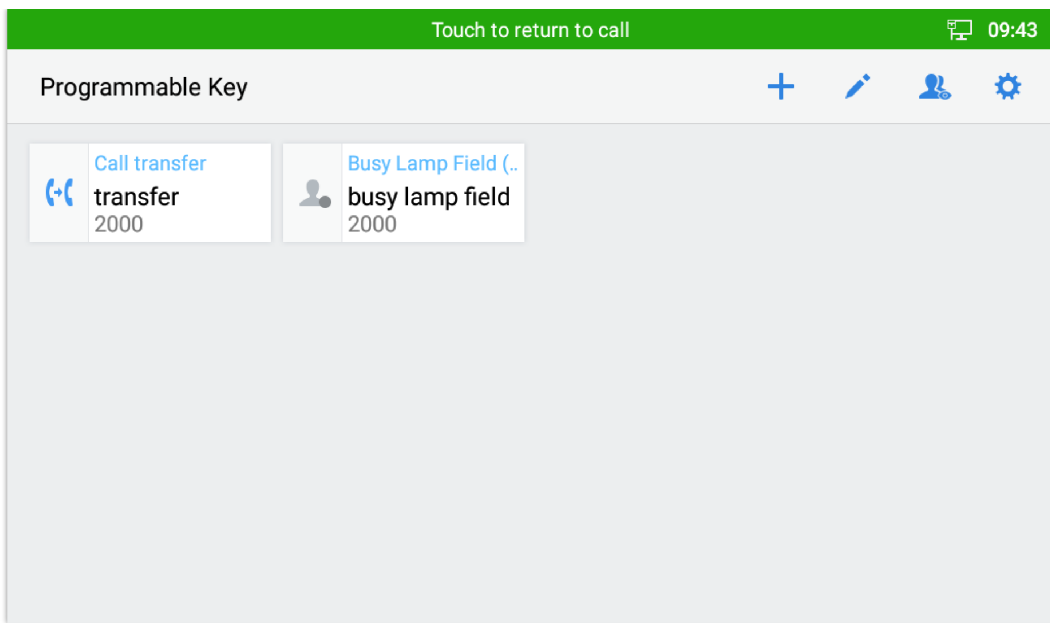



Figure 70: MPK list

3. User can choose an MPK from the list as they see convenient.

## Mute

During an active call, press **"Mute"** to mute the call. The mute icon  will be displayed under the Caller Name and ID.

Press **"Unmute"** to unmute the call.

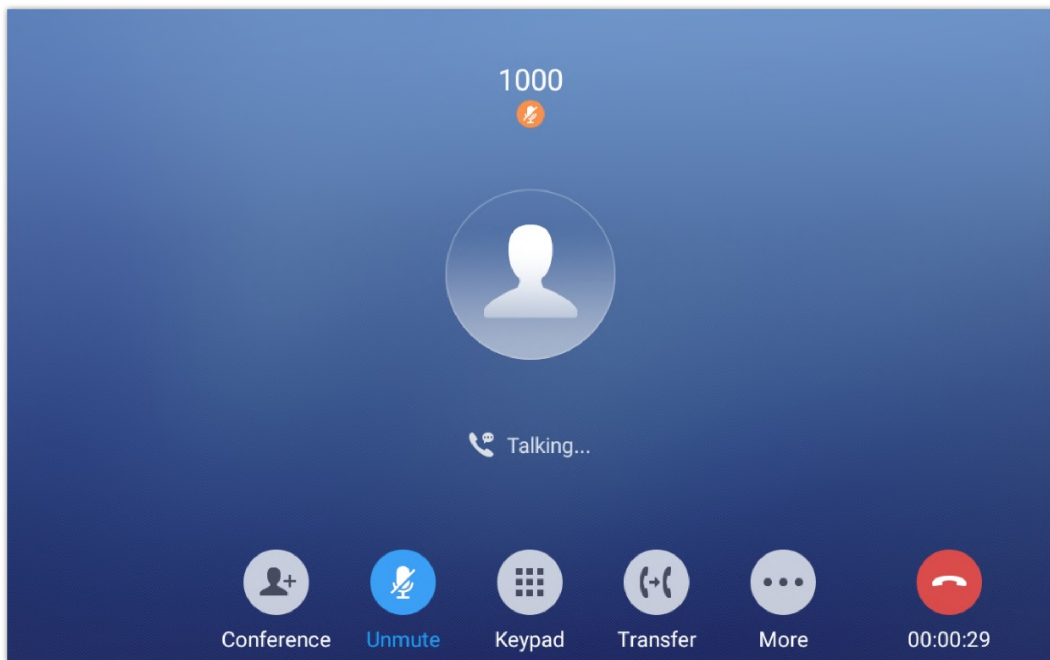

Figure 71: GXV34x0 Call Mute

## Turn on Video during Audio Call

Users could establish audio call first and then turn on video or accept video request during the call if the other party supports video call as well.

- o **Turn on video during audio call**

During an active audio call, on the call screen, tap on "More" and select "Video On", a video request will be sent to the other party.

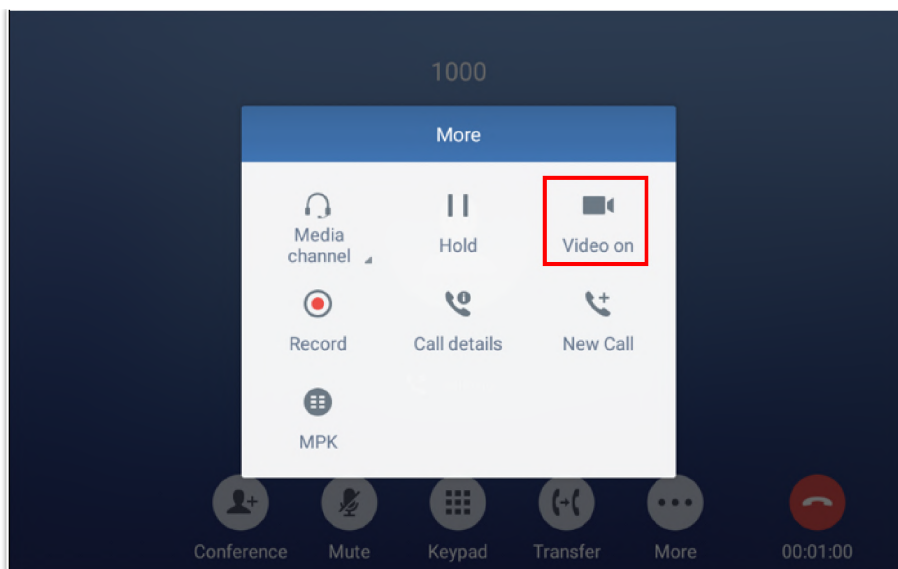
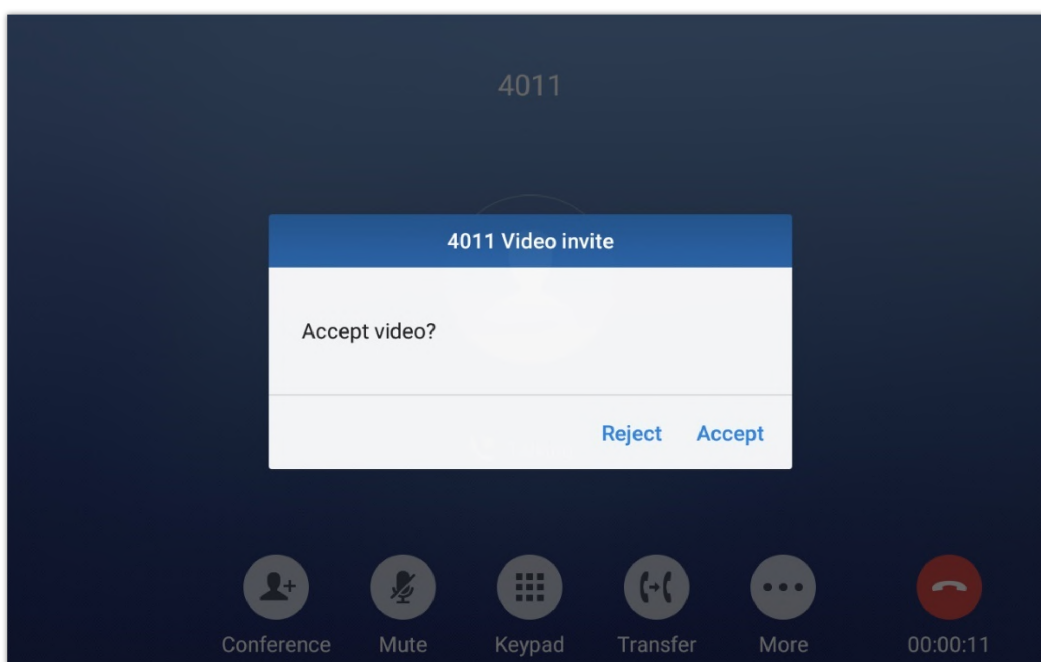

Figure 72: Turn On Video During an Audio Call

o **Accept video request**



Accept Video During Audio Call

If the GXV34x0 receives video request during the audio call, a message "Do you want to accept video?" will be prompted. Select "Yes" to establish video during the call. If the **Enable Video Call Feature** is disabled on GXV34x0, the "Video On" option on GXV34x0 will be hidden during the audio call. However, if the GXV34x0 receives video request during the audio call, users could tap to accept the video request.

**Set video call to full screen**

Once the video call has been established, the user has the option to set its end of the display to full screen by tapping twice on the LCD screen, to exit the full screen mode, click the option displayed below:



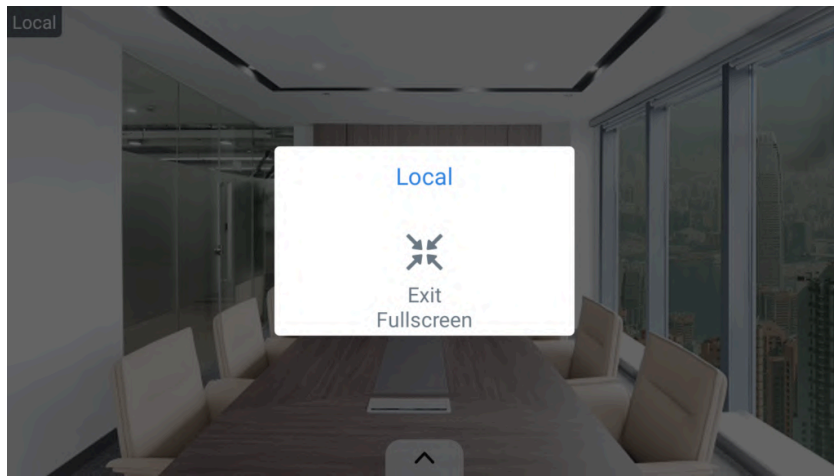

*Exit full screen*

## Virtual background during video call

Once the video call is established, the GXV34xx user can add a virtual background during the call from the available backgrounds, to do that:

1. Click on More to display some additional options.

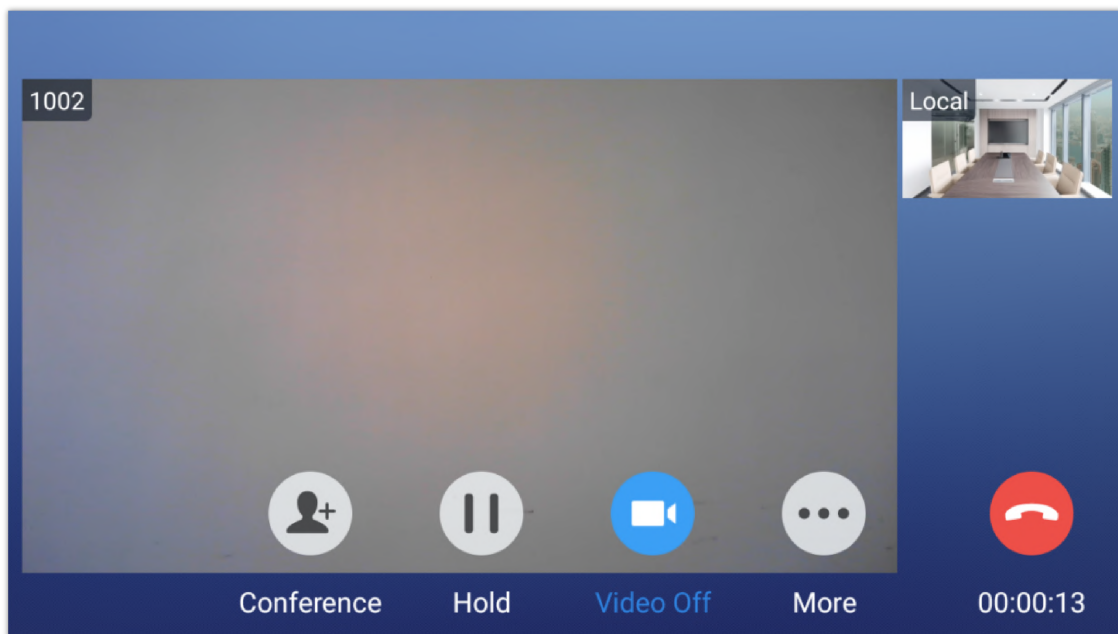

2. Click on Virtual Background.

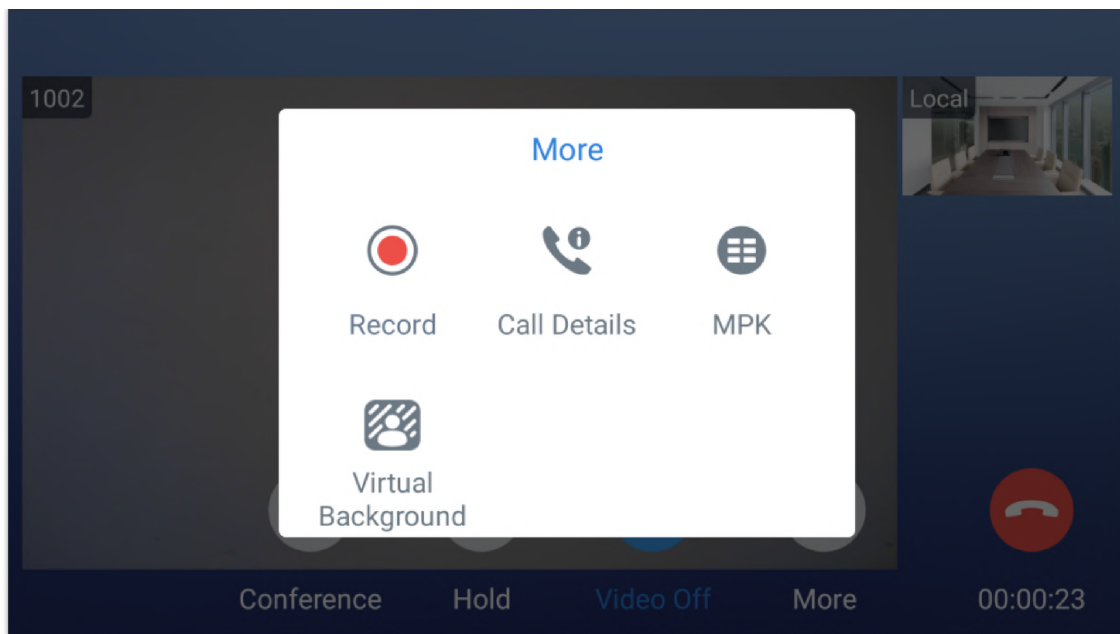



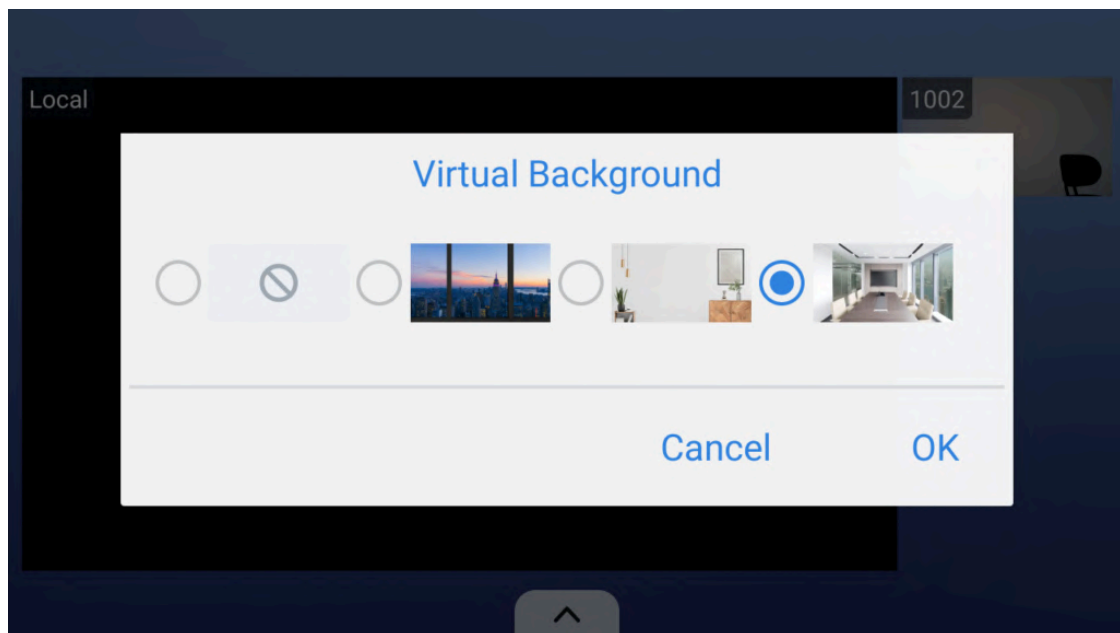

3. Select the desired background.

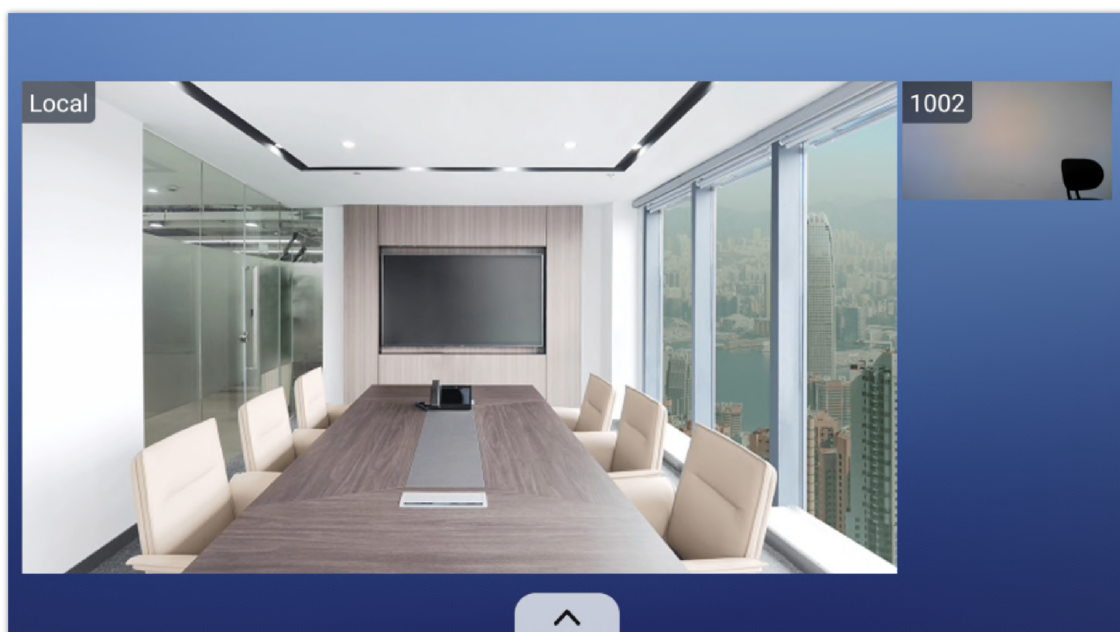

4. Click OK, Now the selected background will be displayed during video calls.



## Switch Audio Channel During Call

- The GXV34x0 allows users to switch among handset, speaker or headset (RJ9 headset, 3.5mm earphone, Plantronics EHS headset and Bluetooth headset) when making calls.
- During a call, tap on the first softkey on the bottom to switch audio channel. Tap on icon  to use handset; tap the icon  to switch to RJ9 headset; tap on icon  to switch to speaker; tap on  to switch to 3.5mm earphone; tap on  to switch to Bluetooth headset.
- If Bluetooth headset is connected, the audio will be automatically switched to Bluetooth headset once the call is established.
- The status bar on the top or the screen shows the current audio channel being used during the call.

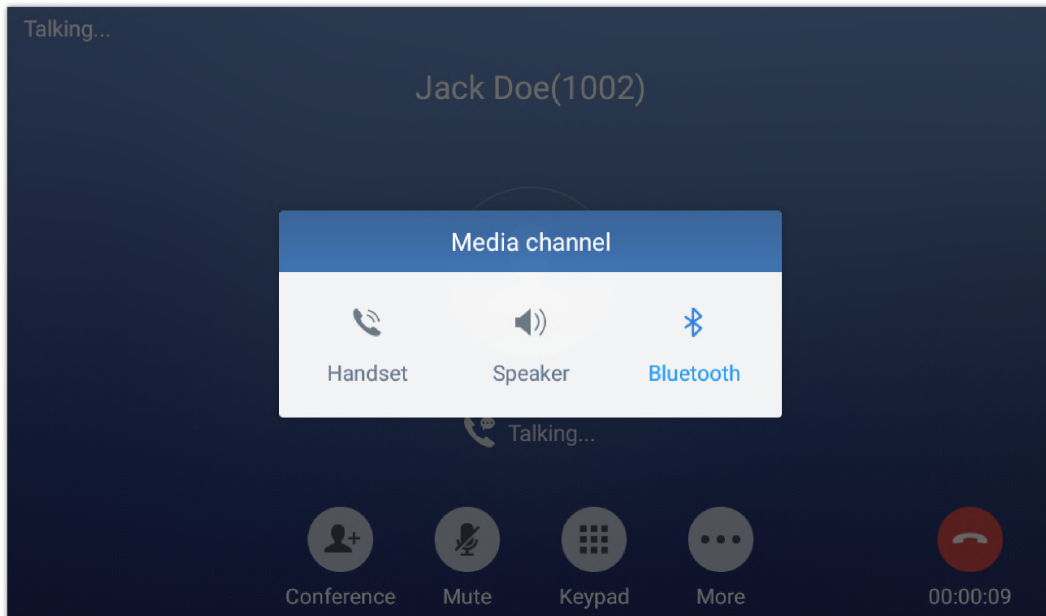

Figure 74: Switch Audio Channel during Call

## Call Transfer

A call can be transferred to another party during the call. The GXV34x0 phones support blind transfer and attended transfer.

### Blind Transfer

1. During the active call, tap on "More" softkey.
2. Select "Transfer" to bring up the transfer screen.
3. Select transfer mode as "Blind" by tapping on the highlight area in **[Figure 61: Blind Transfer]**. The default transfer mode is "Blind".
4. Enter the digits.
5. Tap on "Transfer" softkey.
6. The call will be transferred and GXV34x0 will hang up the call.

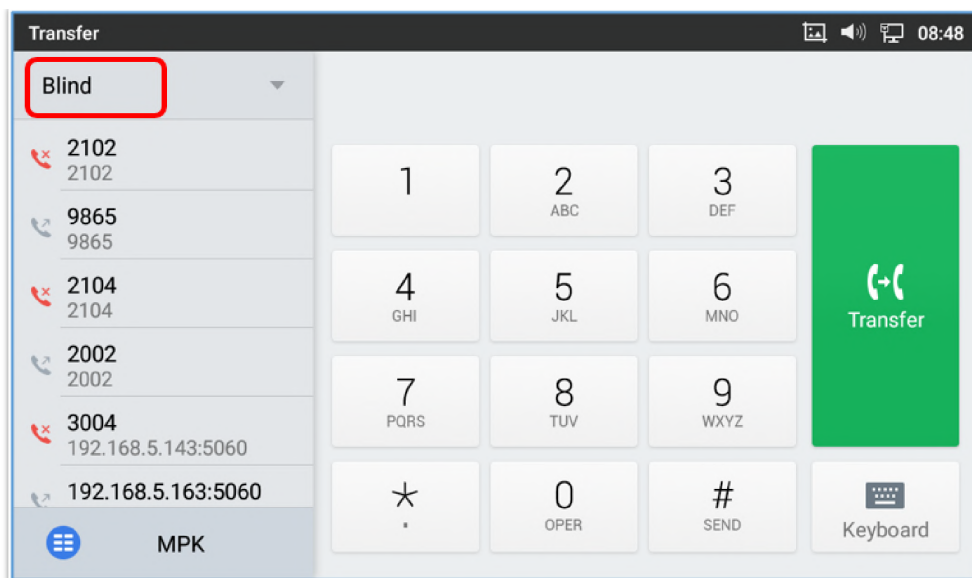



Figure 75: Blind Transfer

**Note**

- o If wrong digits are entered, tap on  to delete the digit one by one.
- o If users would like to cancel the transfer, press  button to go back to the previous talking screen.

**Attended Transfer**

GXV34x0 supports attended transfer:

1. During the active call, tap on **"More"** softkey. Select **"Transfer"** to bring up transfer screen.
2. Select transfer mode as "Attended" by tapping on the mode selection area (see figure below).

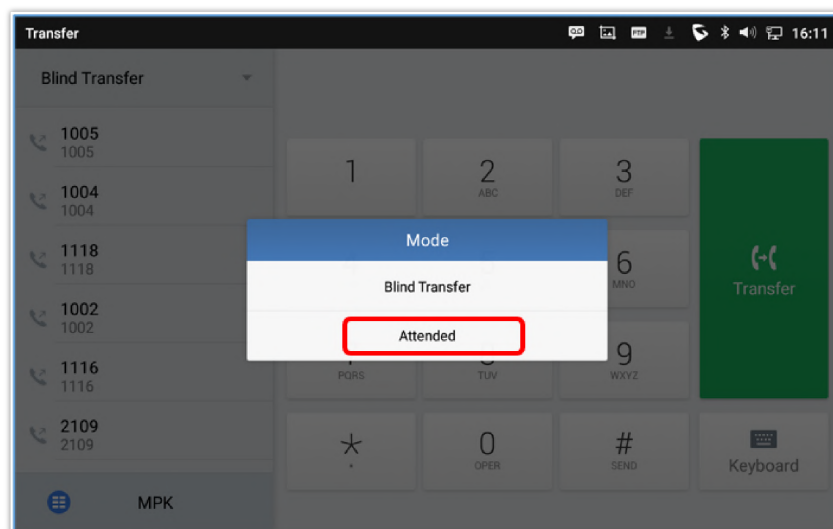

Figure 76: Attended Transfer

3. Enter the transfer target number, and then press the "Send" soft key on the right.
4. Before transfer target answers the call, GXV34x0 hears the ringback tone, and the touch screen prompts shown as below. Users could tap on "End" to cancel the transfer, or tap on "Transfer now" to complete call transfer (Blindly).

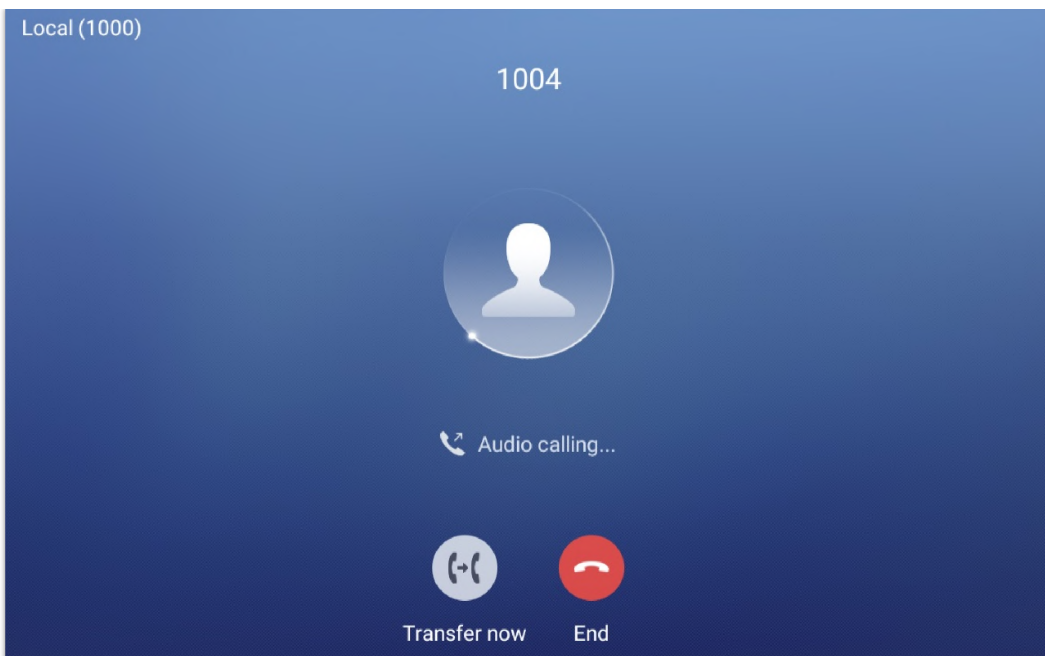

Figure 77: Attended Transfer – Transferring

5. After transfer target answers the call, the following screen will be shown up. If the user taps on Red button, the call will be not be transferred and the original call will be resumed. If the user taps on “Split” soft key to separate the calls, the user will talk to the second established call while the first call is on hold. If the user presses on “Transfer now” the call will be then transferred to the transfer destination.

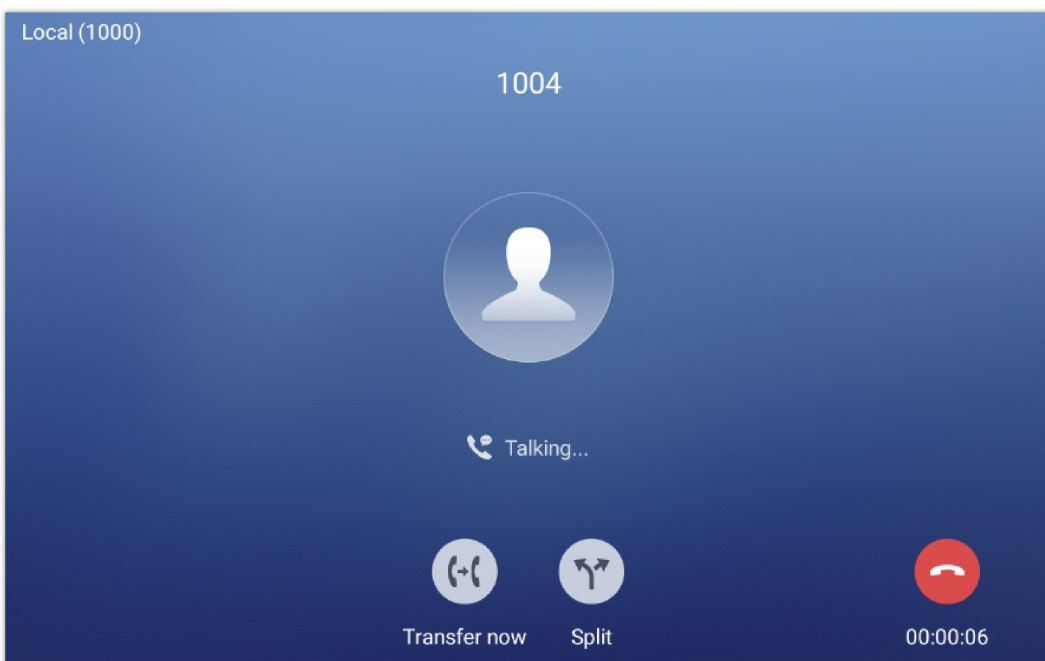
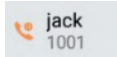
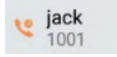

Figure 78: Attended Transfer – Split

Besides attended transfers above, users could also consult the third party first before transferring the call.

1. During the active call, tap More then New Call to make the second call. This will place the current call on hold.
2. The second call establishes after the call is answered.
3. During the active call, tap on “**More**” softkey.
4. Select “Transfer” to bring up transfer screen. The other call on hold will be displayed such as .
5. Select transfer mode as “Attended” in the transfer mode bar and tap on the call on hold such as  to transfer the call.
6. The call will be transferred, and GXV34x0 will hang up the call.



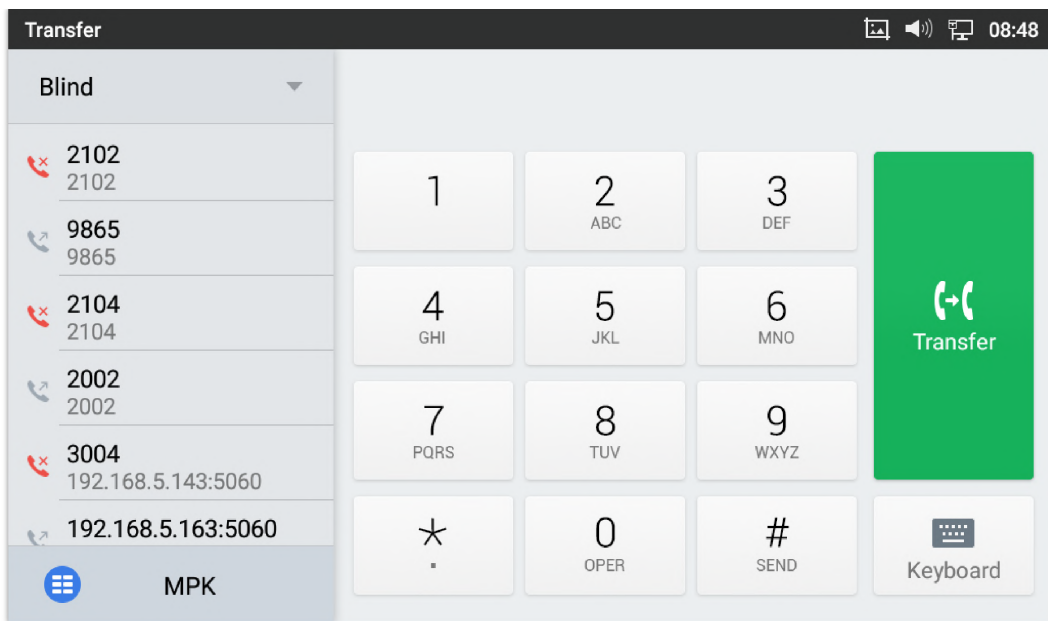



Figure 79: Attended Transfer

**Note**

For the GXV450 model, completing a call transfer can be achieved by pressing the Transfer Key  while in a call.

**Transfer via MPKs**

Users have the possibility to transfer calls via Transfer or non-transfer programmable keys (BLF keys)

1. During an active call, press the **Transfer** softkey then press on **MPK**

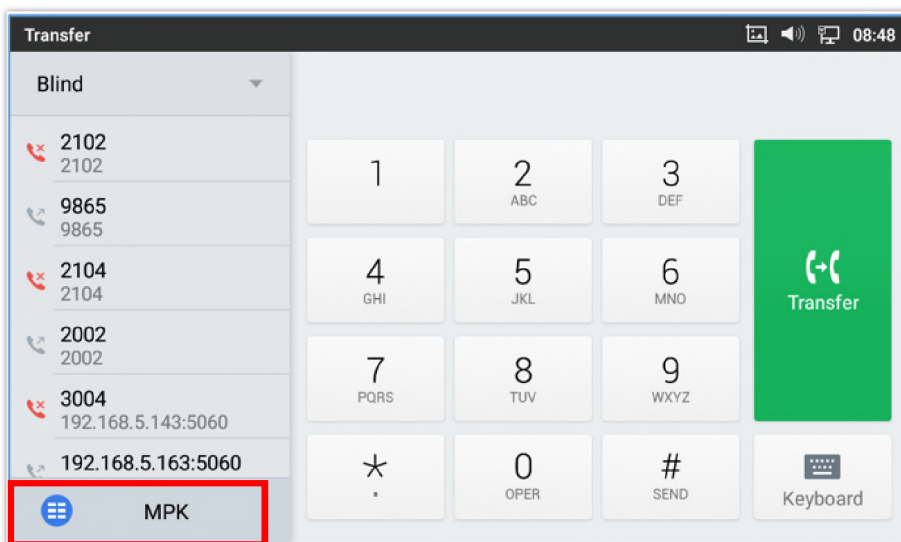

Figure 80: Transfer via MPK

2. Choose the destination to transfer calls to from the MPKs list

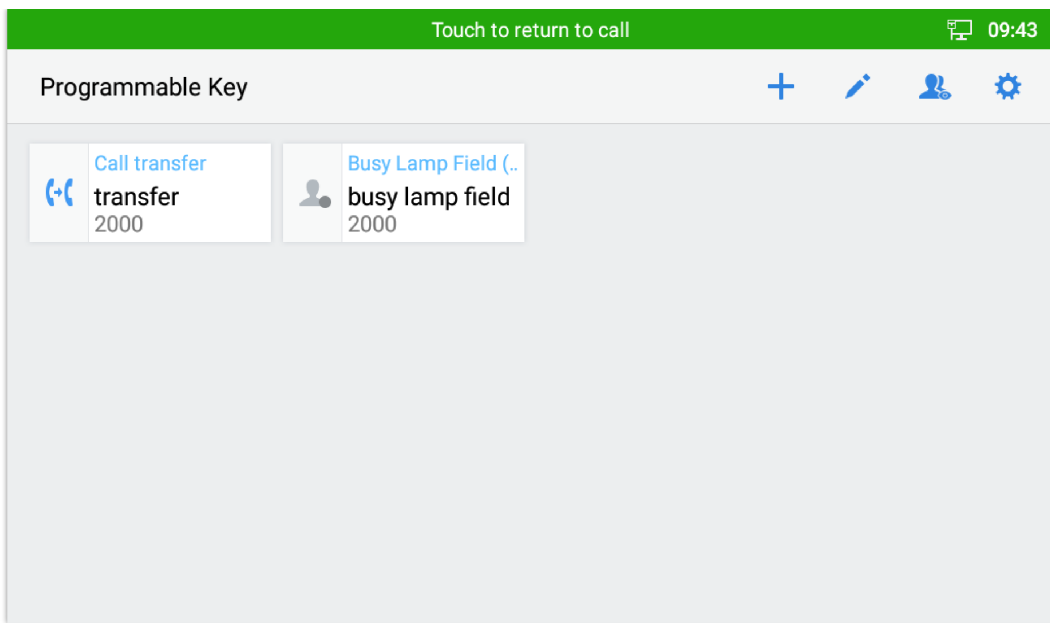

Figure 81: MPK list

**Note:** The transfer via programmable keys will follow the Default Transfer Mode whether it's Blind Transfer or Attended Transfer specified in WEB UI under Phone Settings -> Call Settings -> Default Transfer Mode.

**Note**

- To transfer calls across SIP domains, SIP service providers must support transfer across SIP domains;
- If users would like to cancel the transfer, press ↩button to go back to the previous talking screen.

**X-Way Conference**

- The GXV3480 supports up to 12-way Audio conferencing and 3-way FHD Video conferencing.
- The GXV3470 supports up to 10-way Audio conferencing and 3-way HD Video conferencing.
- The GXV3450 supports up to 10-way Audio conferencing and 3-way HD Video conferencing.

**Initiate Conference**

There are three ways to initiate a conference call.

- **Initiating conference from dial screen**
  1. Bring up the dial screen using one of the methods described previously [Figure 40: GXV34x0 Dial Screen].
  2. Enter the extension number then press on it on the left panel of the screen

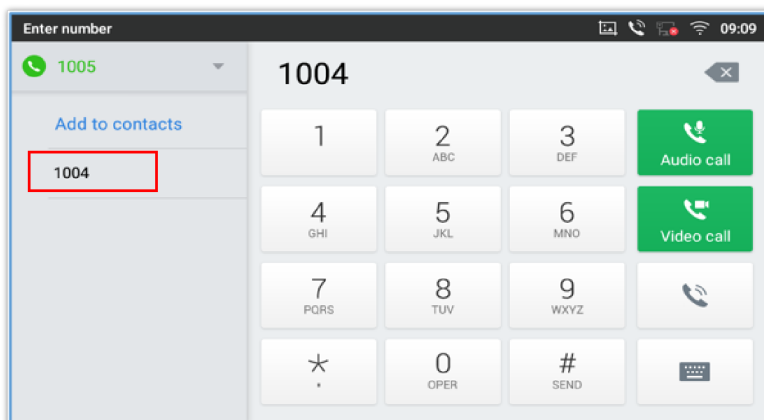

Figure 82: Add Conference Members from Dial Screen



3. The extension number will be added to dialing field and users can dial another number

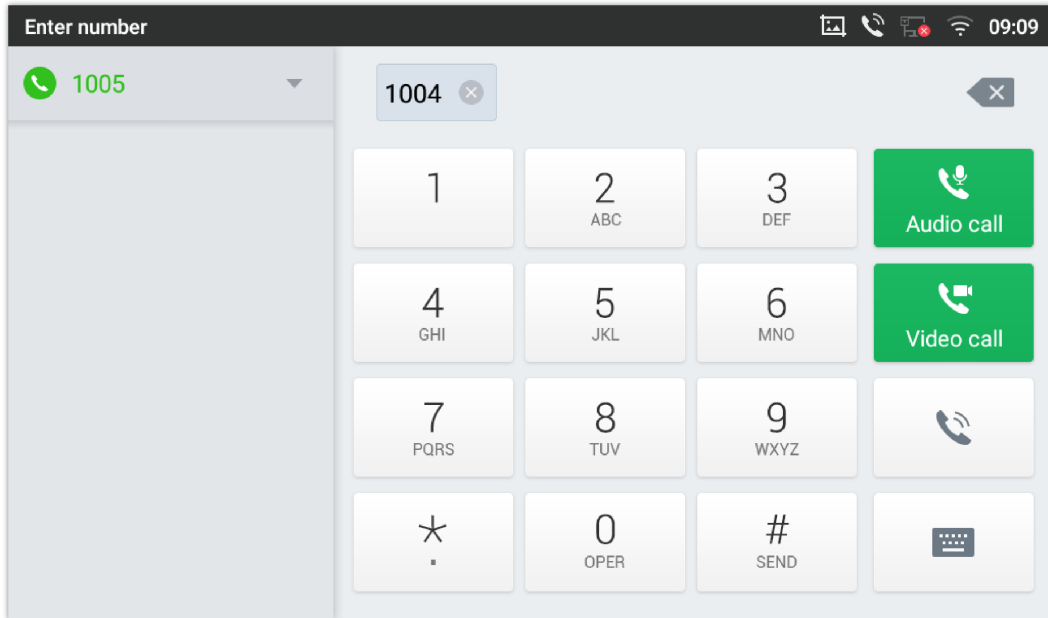



Figure 83: Add Conference Members from Dial Screen 2

4. Using the same method add the other members then press "Audio Call" for an Audio conference or "Video Call" for a video Conference

o **Initiating conference during a phone call**

1. When the phone is on call screen, tap on "Conference" softkey;
2. Enter the third-party number or choose an available number on the left menu from call history or contacts to form a conference of 3. After the call is established, the conference screen is brought up;

3. Tap on  to add another member to the conference;

o **Initiating conference directly using conference soft key**

1. On idle screen, press conference soft key .

2. Tap on  to add the members of the conference.

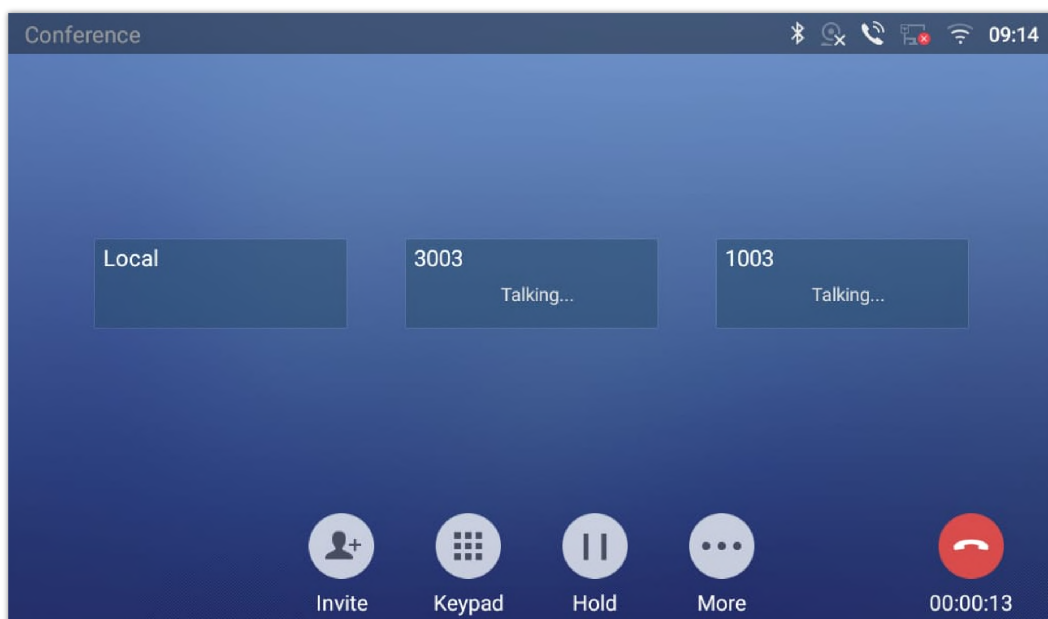



Figure 84: GXV34x0 Conference Screen

**Note:** When users press on  to invite another member to the conference, a dial tone will be heard for the user to start dialing the number.

If there are calls on hold, they will show up when adding member to the conference. Users could then tap on the call to add it to the conference directly.

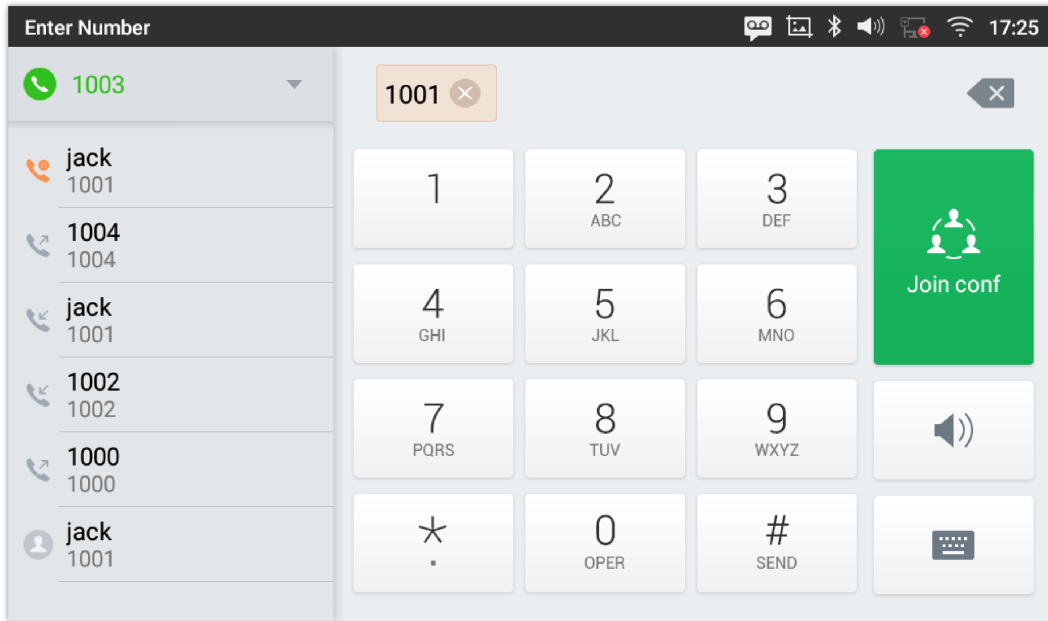

Figure 85: GXV34x0 Conference – Add Existing Call to Conference

3. Repeat the above steps to add more parties into the conference. The following figure shows a 3-way conference established.

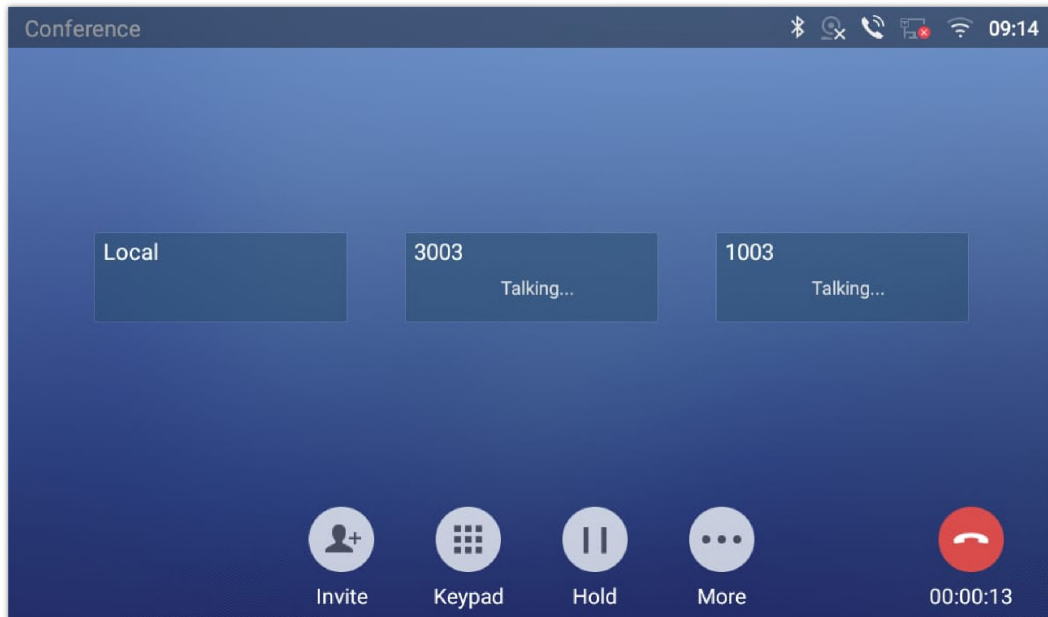

Figure 86: 3-Way Conference Call Established

**Note:** Every time a conference participant joins or exits the conference when using Full screen, a notification will appear in order to make the GXV34x0 host aware of the participant's actions during the conference.

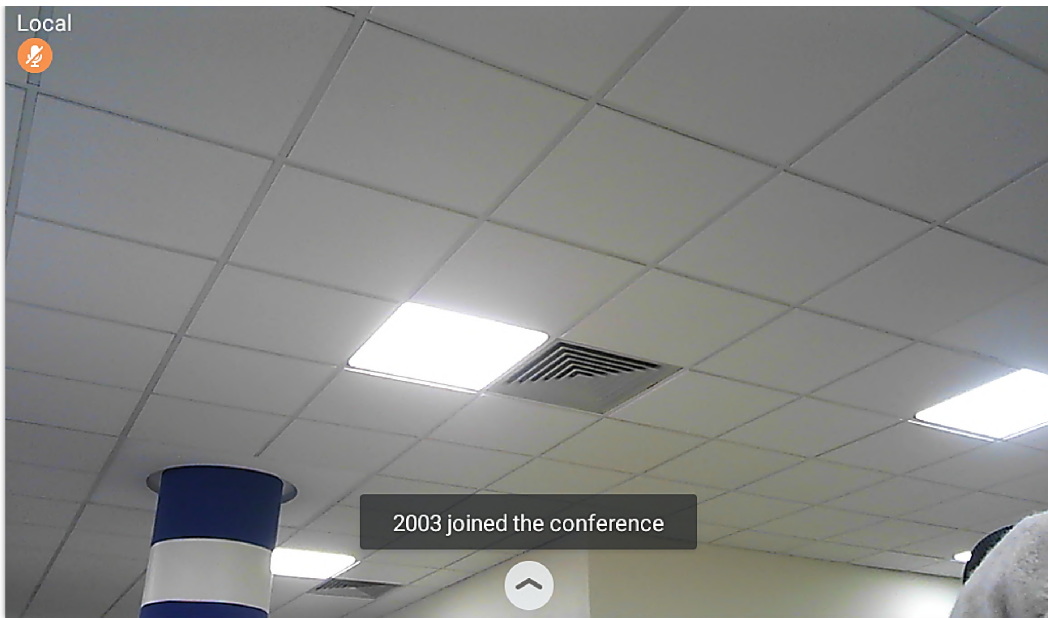

Figure 87: Notification of joining the conference

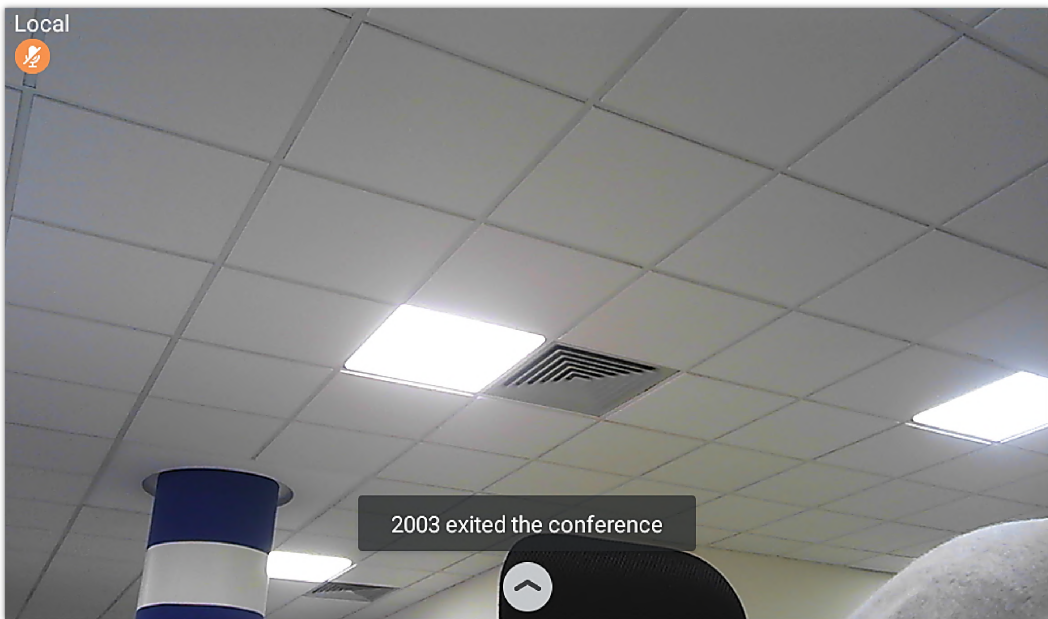



Figure 88: Notification of exiting the conference

## Remove Party from Conference

To remove a party from the conference:

1. Tap on the participant icon of the user you want to remove. The below window will show up giving the possibility to Mute enable video Enlarge or hang up.
2. Tap on icon  to remove the a party from the conference.

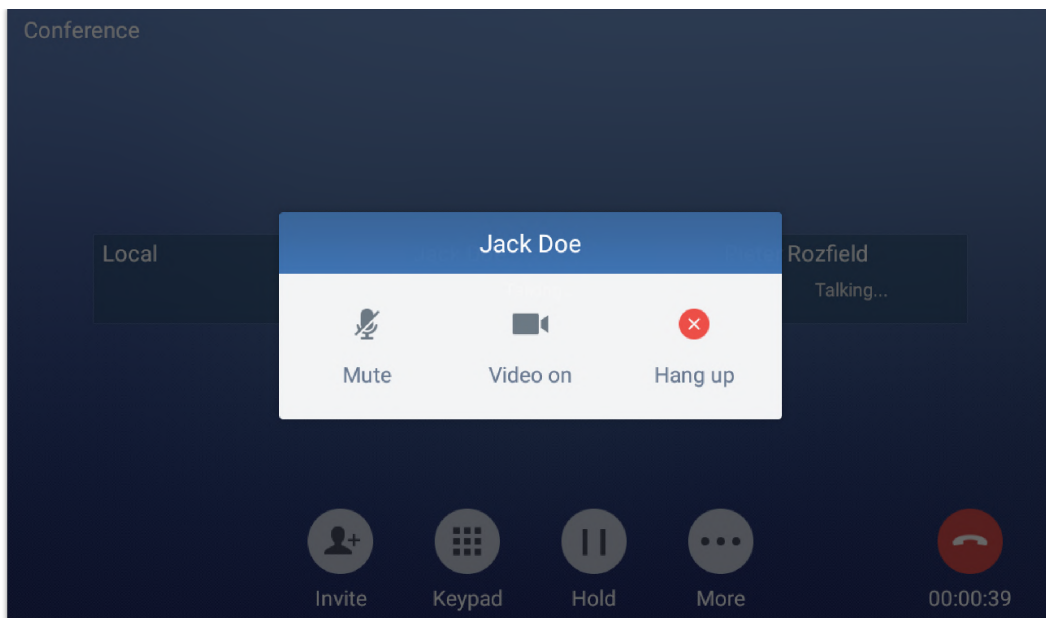



Figure 89: GXV34x0 Conference – Remove Party from Conference

## End Conference

To end the conference, tap on  to disconnect all the parties from the conference. GXV34x0 will hang up the call. If the remote party hangs up the call itself, it will be disconnected from the conference but other parties on GXV34x0 will stay in the existed conference.

## Hold and Resume Conference

During the conference, users could tap on More softkey then tap on Hold to hold the conference at any time. To resume the call tap on Unhold.

## Auto Conference Mode

The GXV34x0 also supports "Auto Conference" which allows users to establish conference call in a quick and easy way, instead of adding the other parties one by one. To enable Auto Conference feature, go to web GUI → **Phone Settings** → **Call Settings** and check "**Auto Conference**".

To establish call with auto conference when there are 1 or more calls on the GXV34x0, simply tap on "More" softkey and select "Conf". All the calls on GXV34x0 will be brought into the conference.

## Initiating Whiteboards from Wave Client

Users initiating calls from the wave app client have the possibility to display a whiteboard for drawing among the methods of screen sharing, this whiteboard is now supported to be displayed during meetings on the GXV34xx models, with the possibility to switch between the whiteboard presentation and the call interface.

An example of initiating a whiteboard during a UCM call will be as follows:

1. The wave extension 1001 invites extensions 1002 and 1000 to a conference meeting
2. Once the call is initiated, extension 1001 have the possibility to share a whiteboard display for the meetings attendees where it will display real time drawings.

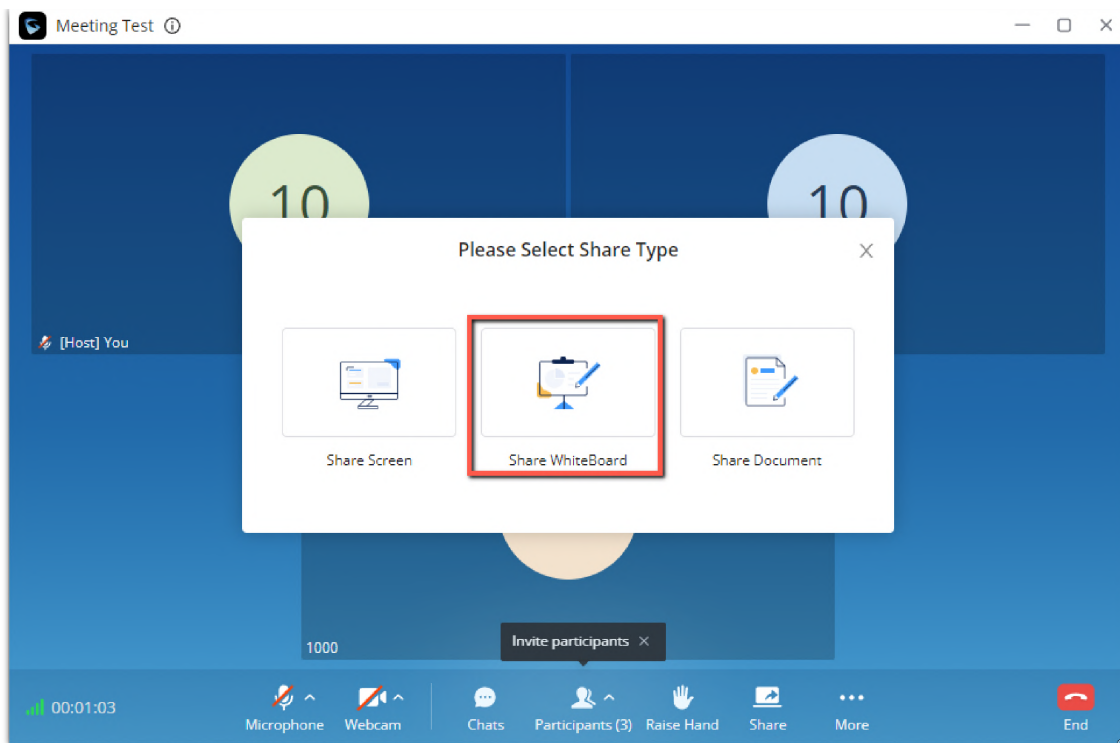

3. The attendees with a GXV34xx model will be able to see the drawings on the whiteboard in real time manner.

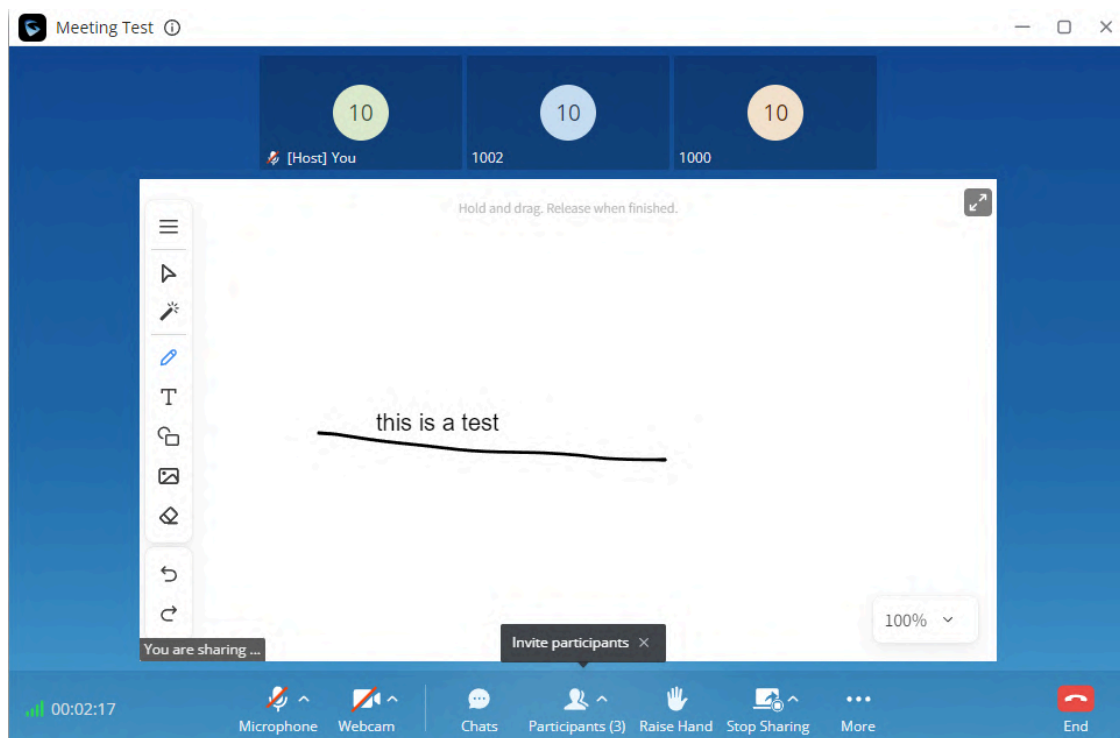

*Whiteboard displayed from the Wave client*



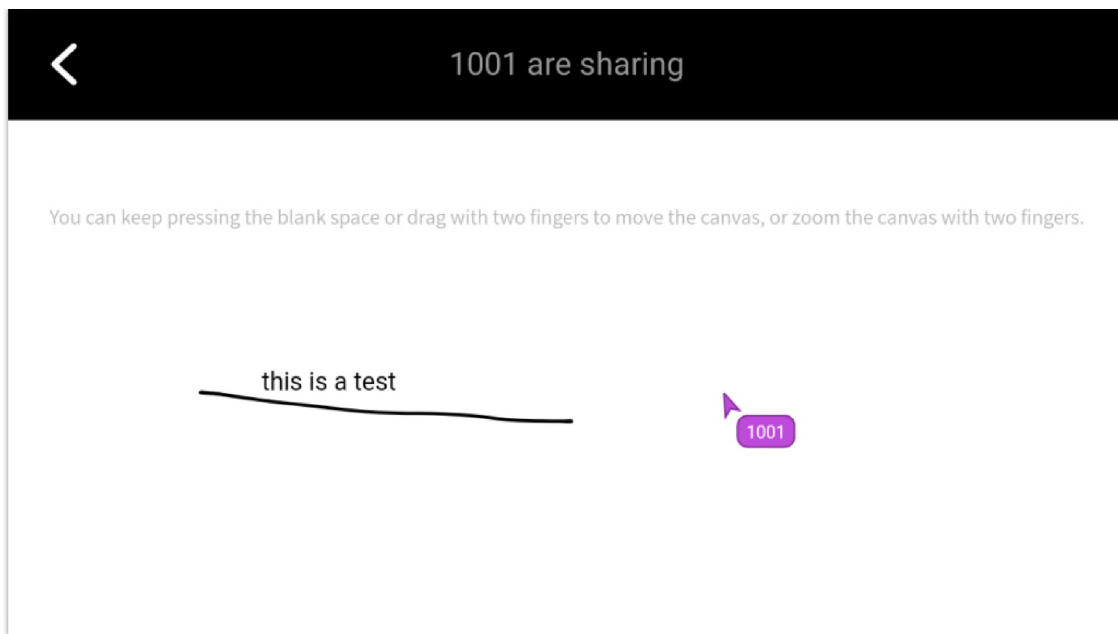

*Whiteboard displayed from the GXV34xx*

4. The attendees from the GXV34xx will also have the possibility to switch between the whiteboard display and the call interface, by clicking the icon highlighted below:

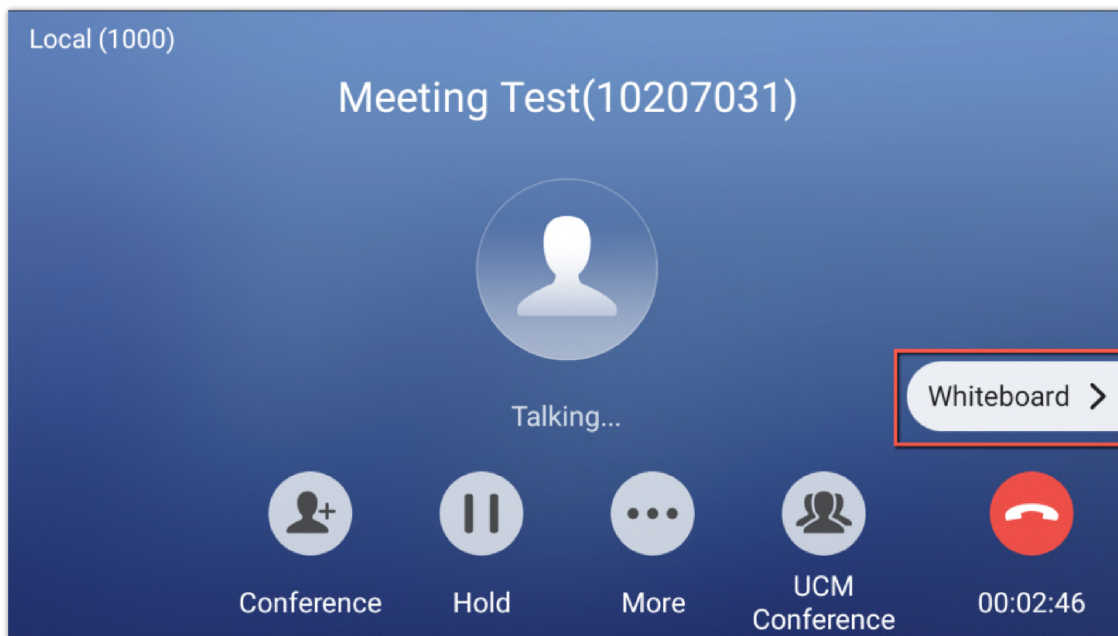

*Switching between Whiteboard and Call interface.*

## Multicast paging

Multicast paging is an approach to let different SIP users to listen to a page from a common multicast IP address. In multicast page call, one way audio will setup from sender to listeners, but the listeners cannot talk to each other. The sender and listeners must be located within the same LAN.

Sender multicast page configurations are under Web UI Settings → Applications → Programmable Key → BLF → Press on Add

1. Set the key Mode to Multicast Paging in dropdown list.
2. Enter the multicast paging description in Display Name field.
3. Enter multicast paging address and port in URL field. The range of multicast page address is 224.0.0.0 to 239.255.255.255 with a port not in use by phone.

To receive multicast page, the GXV34x0 must be well configured to listen to the right address and port. The configurations are under **Phone Settings->Multicast Paging → Multicast Listening**. There are 10 listening address supported. After multicast page listening well configured, please reboot the phone to let the settings take effect.

## Multicast Listening switch

Users can enable/Disable multicast listening feature from Multicast listening widget. When Multicast Listening Widget is set to ON; The phone will be listening to Multicast paging calls.

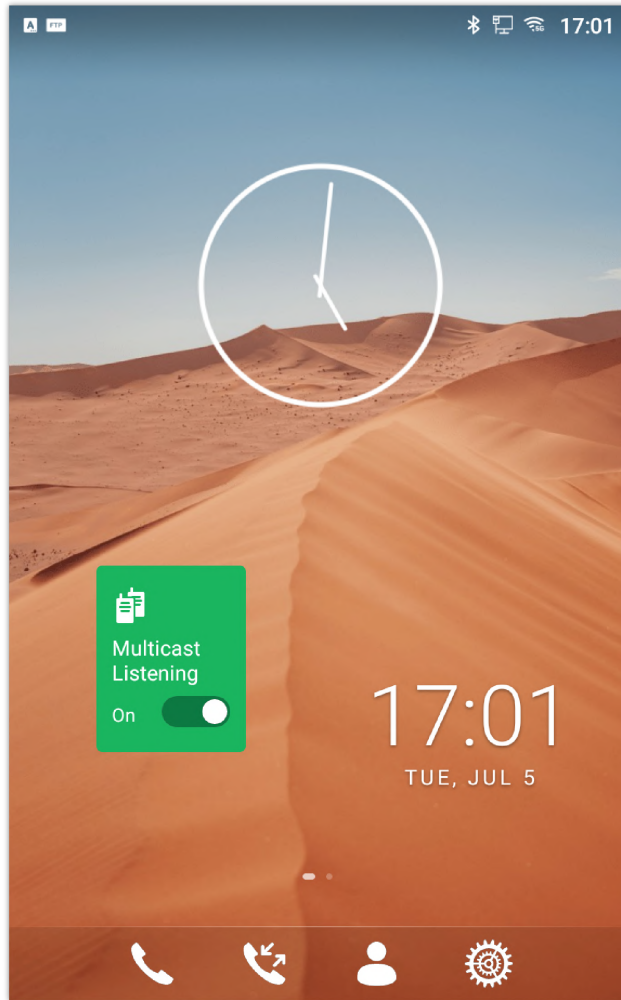
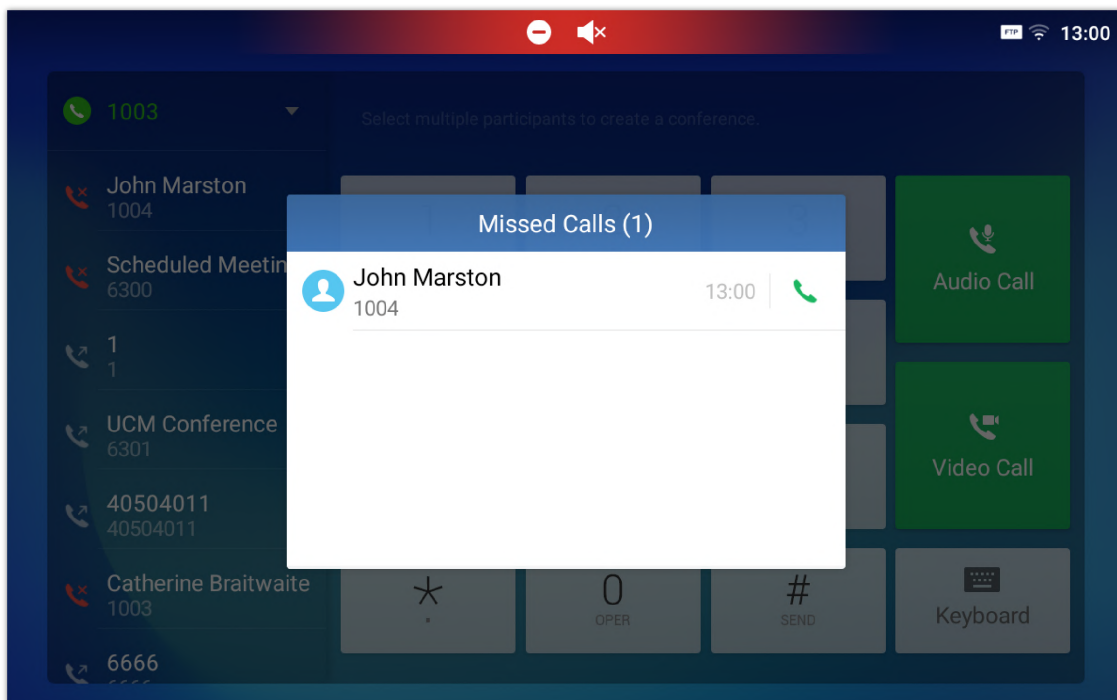

Figure 90: Multicast Paging ON

## Missed Call

When there is a missed call, the LCD will show missed call dialog on the idle screen.







Users can tap on the missed call entry to access the missed call log.

## DND (Do Not Disturb)

When DND is on, the incoming calls to the GXV34x0 will be blocked for all registered accounts with a reminder ring produced. To turn on/off DND:

1. Touch and drag the status bar down on the GXV34x0 idle screen.
2. Tap on the DND icon  to turn it on. The status bar shows icon  indicating DND is on.
3. Tap on the DND icon  to turn it off.

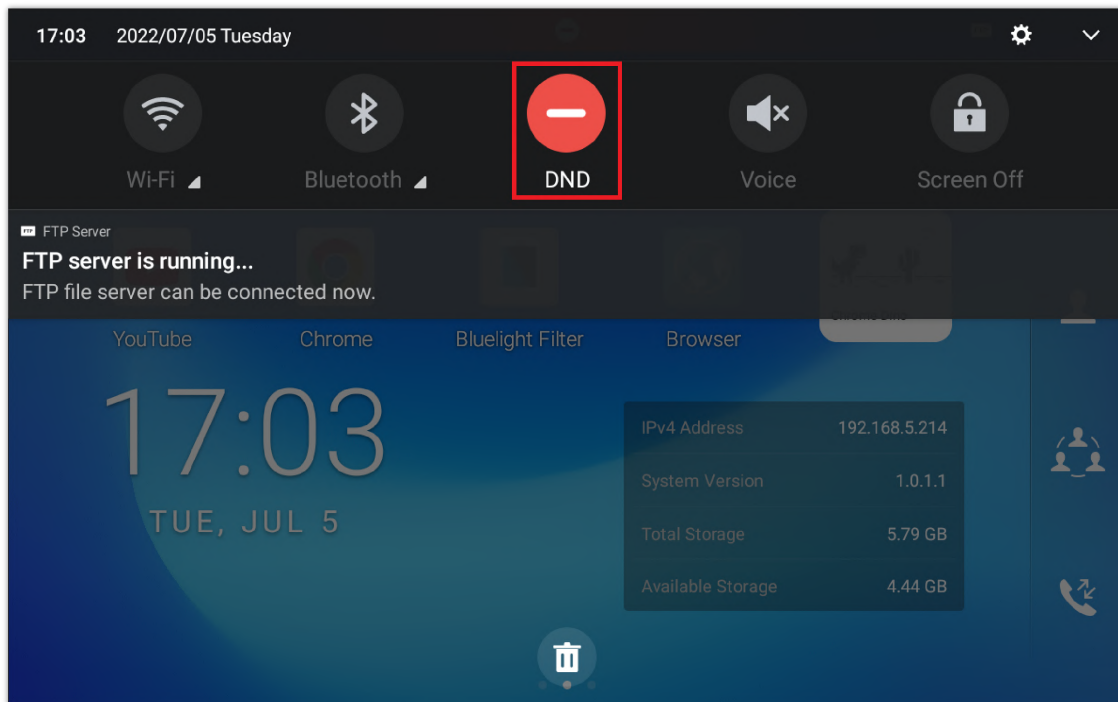



Figure 101: Enable/Disable DND

### Note

- When the phone is in an active call, turning on/off DND won't affect the current active call. It will take effect starting from the next incoming call.

## Voicemail/Message Waiting Indication

When there is a new voicemail, the Message Waiting Indication (MWI) LED icon will blink in red on the upper right corner of the GXV34x0 and  will show up in the status bar.

To retrieve the voicemail:

1. Tap on the Message icon  from the applications section to bring up voicemail screen. All the registered accounts and the number of voicemails are displayed there.
2. Tap on the account to dial into the voicemail box. Then follow the Interactive Voice Response (IVR) for the message retrieval process.

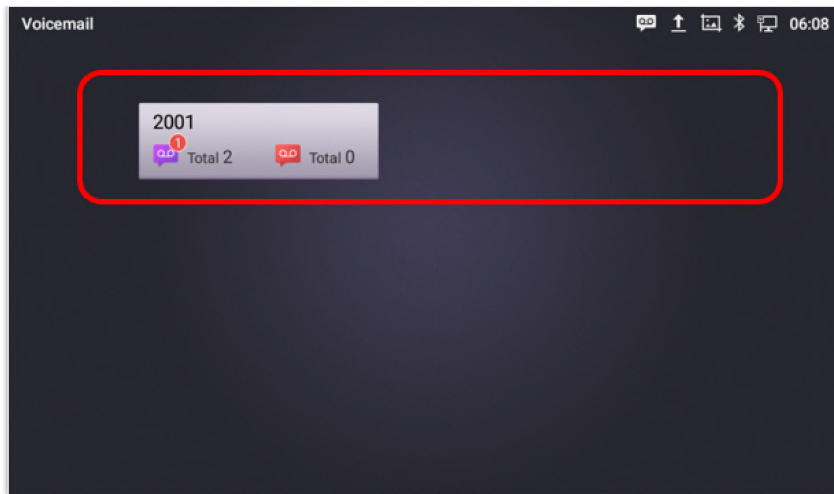

Figure 102: Retrieve Voicemail

For each account, the Voicemail User ID can be set up under web GUI → **Account** → **SIP** → **Account X** → **General Settings**: “Voice Mail Access Number”. This is the number that will be dialed out to access voicemail message when tapping on the account in Voice Mail screen.

## Call Forward

Call forward feature can be set up from GXV34x0 LCD or web GUI.

- **From LCD**

Go to onscreen Menu → **Settings** → **Features** → Call Forward. Select account name and tap on **Call Forwarding** to activate the feature. Then the list of options will be available. Select the option Call Forward Mode to configure the call forward type (Unconditional, Time Based, Others) and then enter necessary number in the fields.

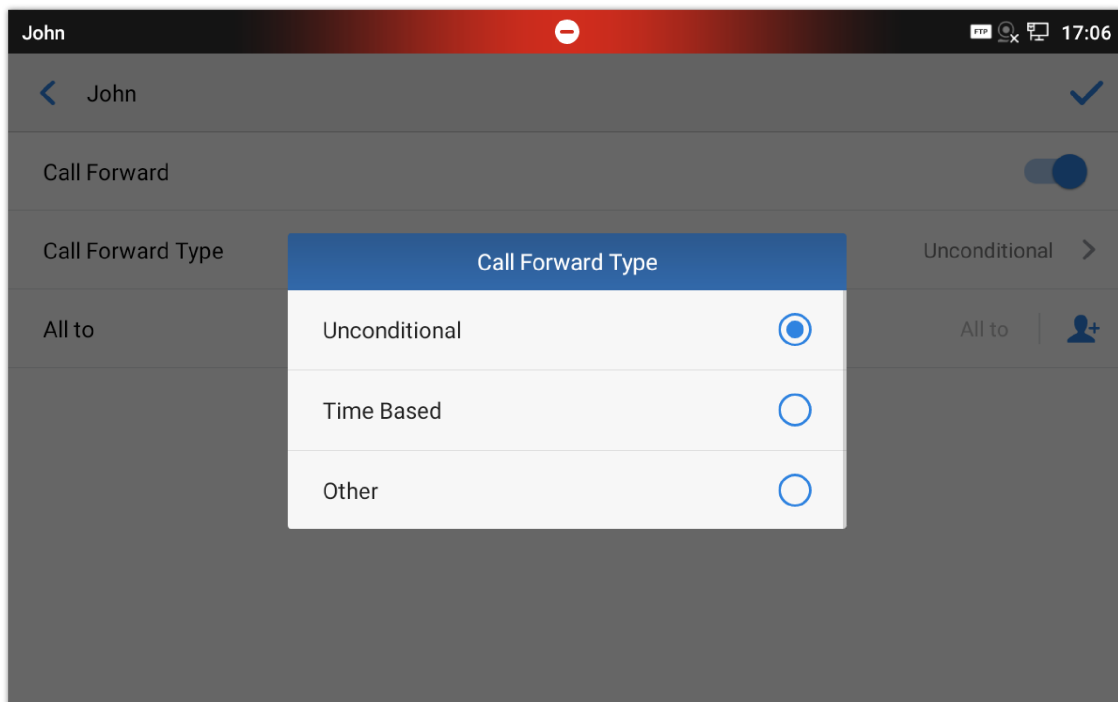

Figure 103: Unconditional Call Forward

- **From Web GUI**

Log in GXV34x0 web GUI and go to **Account** → **Account X** → **Call Settings** → **Call Forward**. By default, Call Forward feature is set to “None”. The Call Forward feature options are:

- **Unconditional Forward:** All the incoming calls will be forwarded to the number set up in “All To” field.

Figure 104: Call Forward – Unconditional

- Time Based Forward:** All the incoming calls will be forwarded to the number as schedule in the time period. During the setup time, the call will be forwarded to the number in “In Time Forward To:” field. Other period the call will be forwarded to the number in “Out Time Forward To:” field.

Figure 105: Call Forward – Time Based

- Call Forward on Busy / Call Forward No Answer / Call Forward on DND:** The incoming call will be forwarded when the GXV34x0 is busy or no answer after certain interval “Delayed Call Forward Wait Time (s)”, or if the phone is on DND mode then the call will be forwarded to the configured destination number.

Figure 106: Call Forward – Busy/No Answer/DND

## Call Features

The GXV34x0 supports traditional and advanced telephony features including caller ID, caller ID with caller Name, call waiting, call forward etc. Before using the following feature codes, please make sure “Enable Call Features” option is set to “Yes” under web GUI→**Account** page→**Call Settings**.

Feature Code	Description
*01	<p><b>Use Preferred Codec</b> (per call)</p> <ul style="list-style-type: none"> <li>Dial *01 followed by the preferred codec code and the phone number.</li> <li>The phone will try to use this codec during the call.</li> <li>Codec code: <b>PCMU</b>: 7110 – <b>PCMA</b>: 7111 – <b>G726-32</b>: 72632 – <b>G722</b>: 722 – <b>iLBC</b>: 7201</li> </ul> <p>For example, if the user would like to use PCMA as the preferred codec to call phone number 334455, enter *017111334455.</p>

*02	<p><b>Force Codec</b> (per call)</p> <ul style="list-style-type: none"> <li>• Dial *02 followed by the preferred codec code and the phone number.</li> <li>• The phone will try to use this codec during the call.</li> <li>• Codec code: <b>PCMU</b>: 7110 – <b>PCMA</b>: 7111 – <b>G726-32</b>: 72632 – <b>G722</b>: 722 – <b>iLBC</b>: 7201</li> </ul> <p>For example, if the user would like to use PCMA to call phone number 334455, enter *027111334455.</p>
*30	<p><b>Block Caller ID</b> (for all subsequent calls)</p> <ul style="list-style-type: none"> <li>• Dial *30.</li> </ul>
*31	<p><b>Send Caller ID</b> (for all subsequent calls)</p> <ul style="list-style-type: none"> <li>• Dial *31.</li> </ul>
*50	<p><b>Disable Call Waiting</b></p> <ul style="list-style-type: none"> <li>• Dial *50.</li> </ul>
*51	<p><b>Enable Call Waiting</b></p> <ul style="list-style-type: none"> <li>• Dial *51.</li> </ul>
*67	<p><b>Block Caller ID</b> (per call)</p> <ul style="list-style-type: none"> <li>• Dial *67 followed by the phone number.</li> </ul>
*82	<p><b>Send Caller ID</b> (per call)</p> <ul style="list-style-type: none"> <li>• Dial *82 followed by the phone number.</li> </ul>
*70	<p><b>Disable Call Waiting</b> (per Call)</p> <ul style="list-style-type: none"> <li>• Dial *70 followed by the phone number.</li> </ul>
*71	<p><b>Enable Call Waiting</b> (per Call)</p> <ul style="list-style-type: none"> <li>• Dial *71 followed by the phone number.</li> </ul>
*72	<p><b>Unconditional Call Forward.</b> To set up unconditional call forward:</p> <ul style="list-style-type: none"> <li>• Dial *72 followed by the phone number to forward the call.</li> </ul>
*73	<p><b>Cancel Unconditional Call Forward.</b> To cancel the unconditional call forward:</p> <ul style="list-style-type: none"> <li>• Dial *73.</li> </ul>
*74	<p><b>Paging Call</b></p> <ul style="list-style-type: none"> <li>• Dial *74 followed by the phone number to send the paging call.</li> </ul>
*83	<p><b>Force Audio Calling</b> (per call)</p> <ul style="list-style-type: none"> <li>• Dial *83 followed by the phone number to send the audio call.</li> </ul>
*84	<p><b>Force Video Calling</b> (per call)</p> <ul style="list-style-type: none"> <li>• Dial *84 followed by the phone number to send the video call.</li> </ul>

*90	<p><b>Busy Call Forward.</b> To set up busy call forward:</p> <ul style="list-style-type: none"> <li>• Dial *90 followed by the phone number to forward the call.</li> </ul>
*91	<p><b>Cancel Busy Call Forward.</b> To cancel the busy call forward:</p> <ul style="list-style-type: none"> <li>• Dial *91.</li> </ul>
*92	<p><b>Delayed Call Forward.</b> To set up delayed call forward:</p> <ul style="list-style-type: none"> <li>• Dial *92 followed by the number to forward the call. The default timeout before the call is forwarded is 20 seconds.</li> </ul>
*93	<p><b>Cancel Delayed Call Forward.</b> To cancel the delayed call forward:</p> <ul style="list-style-type: none"> <li>• Dial *93.</li> </ul>

Table 21: GXV34x0 Feature Code

## CONTACTS

The GXV34x0 supports local, LDAP and BroadWorks Xsi Contacts.

To access GXV34x0 contacts, on the phone's idle screen, tap on icon  on the right panel. The following figure shows Contacts on the GXV34x0.

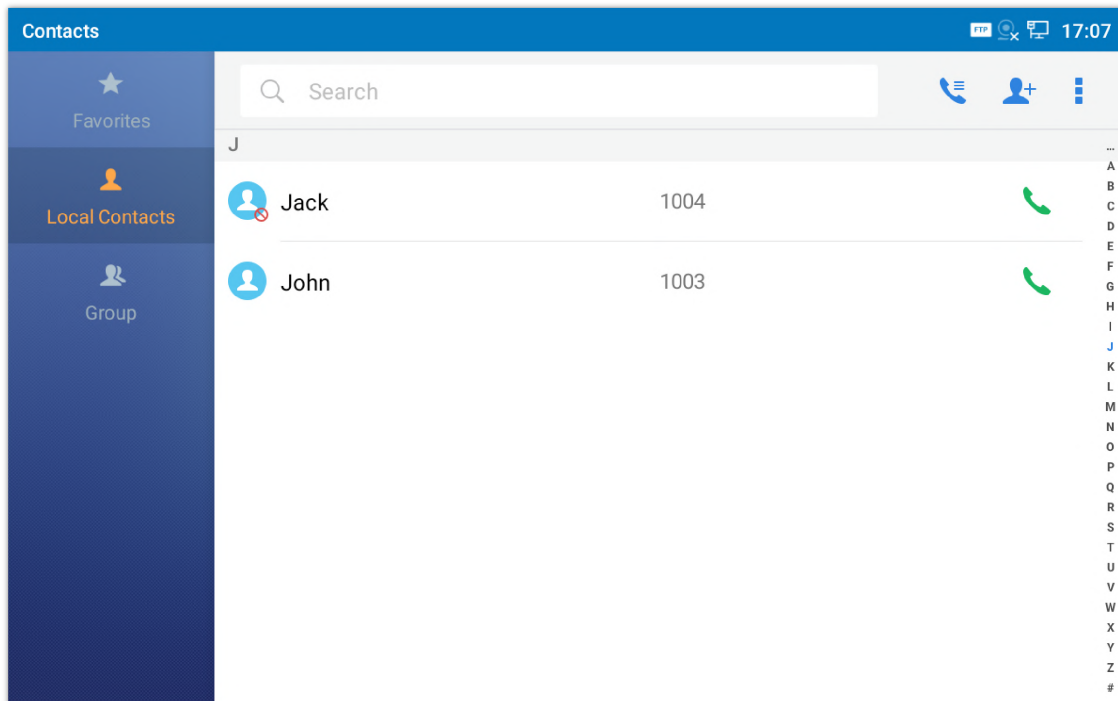

Figure 107: GXV34x0 Contacts

The BS Contacts is the BroadWorks Xsi Contacts. It needs to be configured with the remote BroadWorks server to enable this feature.

### Local Contacts

The local contacts can save up to 1000 entries. Users can manage contacts by adding, deleting and modifying single contacts, downloading contacts from HTTP/TFTP server, importing contacts from external storage and exporting contacts to external storage.

**Note:** A reminder prompt is shown on the GXV34x0 LCD screen when adding a number of contacts more than the allowed one (when importing contacts for instance).

## Add Single Contacts

1. On the Local Contacts menu Tap on  to bring up "Create Contact" dialog to manually add a new contact. See [Figure 94: GXV34x0 Contacts – Add New Contact].
2. Type First name, Last name, Phone number and other information for the new contacts. Please make sure the account number field is selected so the GXV34x0 will use this account to dial out the new contact. The account number field is located on the left of the "Phone" field as highlighted below.

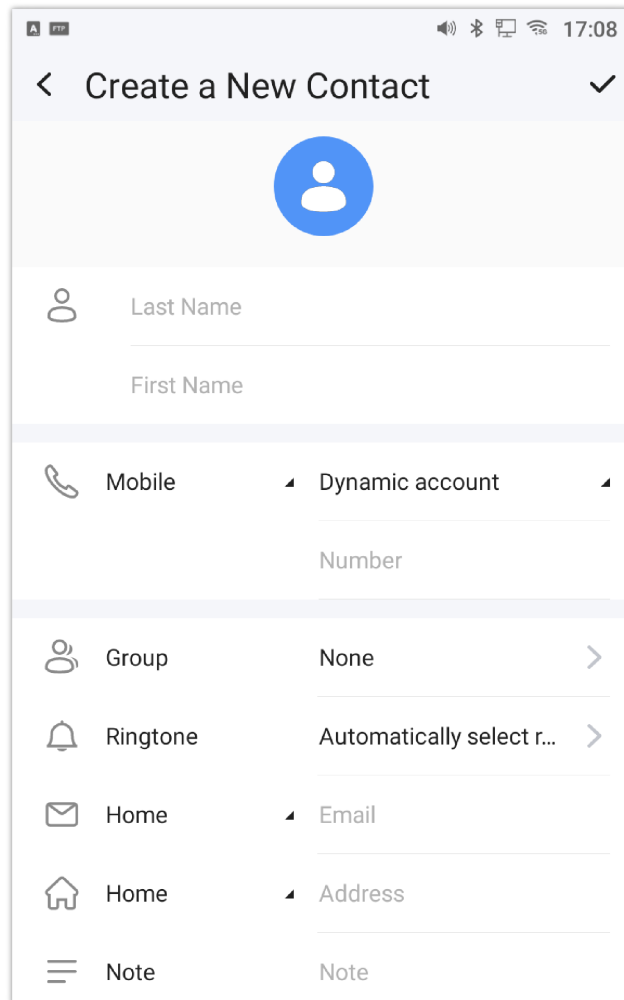

The screenshot displays the "Create a New Contact" dialog. At the top, there is a blue person icon. Below it, there are two input fields: "Last Name" and "First Name". The "Mobile" field is selected, showing a dropdown menu with "Dynamic account" and "Number" options. Other fields include "Group" (None), "Ringtone" (Automatically select r...), "Home" (Email), "Home" (Address), and "Note".

Figure 108: GXV3470 Contacts – Add New Contact

## Import/Export Contacts

If the users have the GXV34x0 phonebook file saved in local storage or external storage device that has been plugged into the GXV34x0, the phonebook file can be directly imported to the Contacts. There are two different formats supported for the phonebook file: "vcard", and "xml". Users could manually create contacts first and export the phonebook file in vcard or xml format to take a look on the phonebook file.

### To Import Contacts:

1. Open Contacts.
2. Tap on More  on the upper right corner of the Contacts screen.
3. Select "Import contacts" to bring up the dialog below.
4. Fill in the import options and scroll down to the bottom of the screen.
5. Tap on "Select file" to import phonebook file from the directory in internal or external storage device.

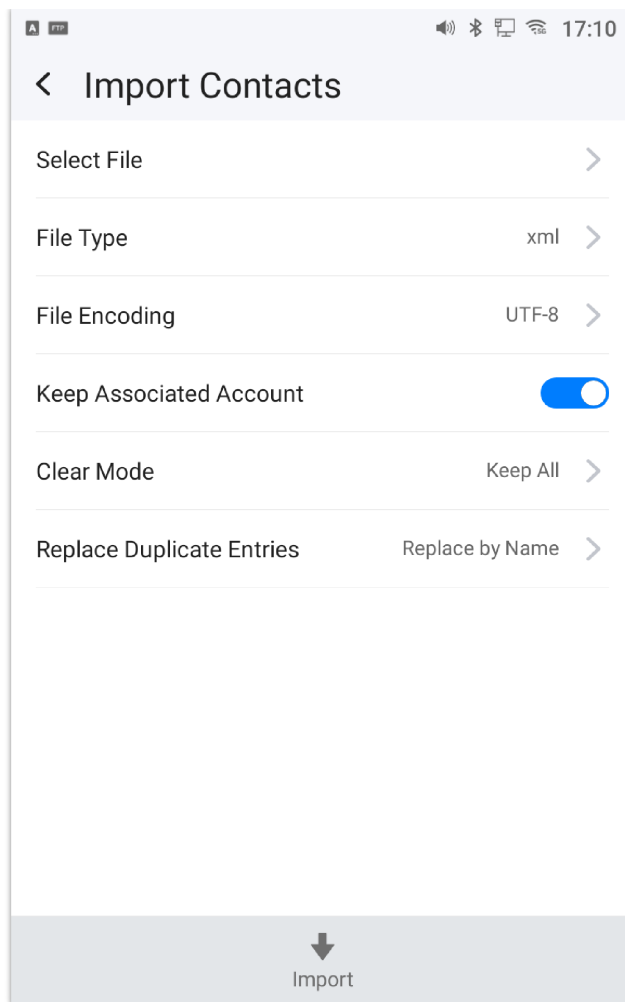



Figure 109: GXV34x0 Contacts – Import Contacts

**To Export Contacts:**

1. Open Contacts.
2. Tap on More  on the upper right corner of the Contacts screen.
3. Select "Export Contacts " to bring up dialog below.
4. Select the file encoding and file type for the exported phonebook file. By default, the GXV34x0 is using "UTF-8" as the encoding method.
5. Tap on "Choose Directory" and select the directory where the phonebook file will be exported to.

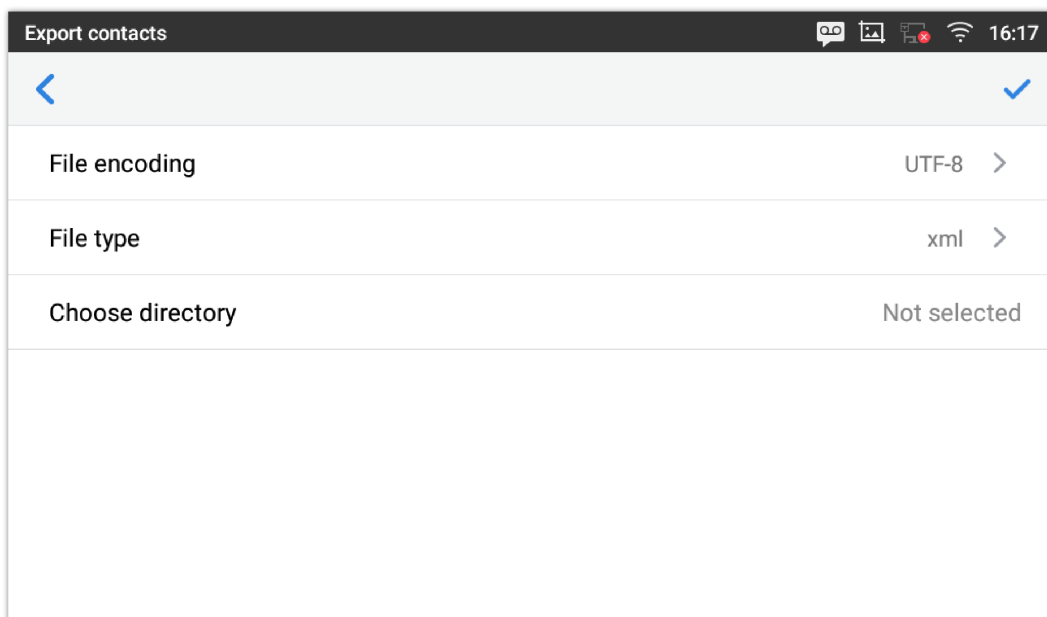



Figure 110: GXV34x0 Contacts – Export Contacts



## Download Contacts

The GXV34x0 supports downloading XML phonebook from a remote HTTP/TFTP/HTTPS server to local Contacts. When downloading the phonebook, the GXV34x0 sends request to the HTTP/TFTP/HTTPS server looking for file **phonebook.xml**. For more details about GXV34x0 phonebook, please refer to this <https://documentation.grandstream.com/knowledge-base/gxv33xx-series-xml-phonebook-guide/>.

### To download phonebook:

1. Make sure the GXV34x0 can connect to the HTTP/TFTP/HTTPS server and the phonebook.xml file in correct format is downloadable from the HTTP/TFTP/HTTPS server.
2. Open Contacts.
3. Tap on More  on the upper right corner of the Contacts screen.
4. Select "Download Contacts" to bring up the dialog below.
5. Fill in the necessary options and then tap on  in the upper right corner of the screen. The GXV34x0 will send out request to the configured HTTP/TFTP/HTTPS server.

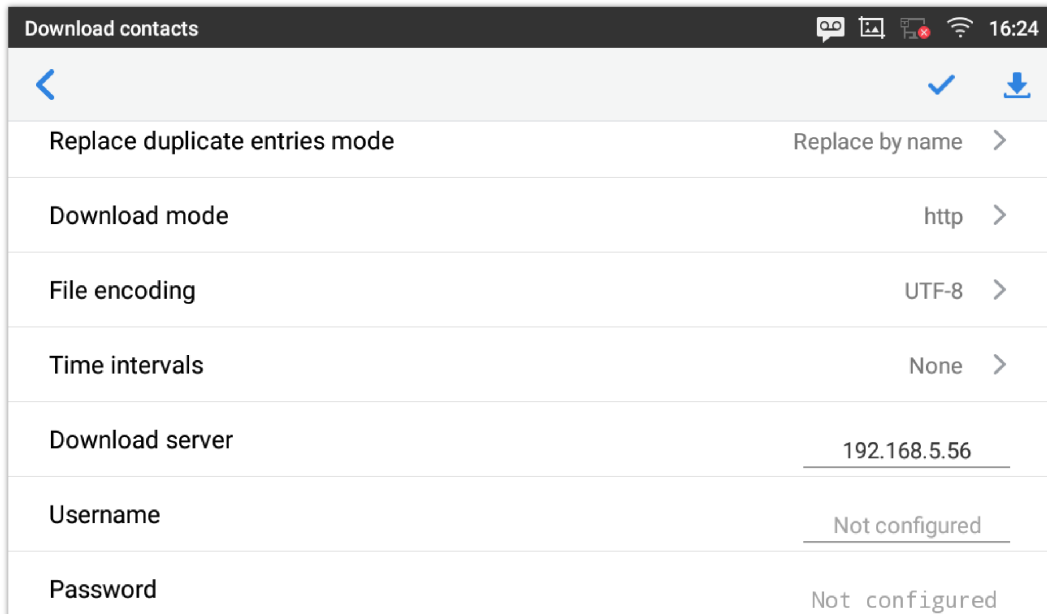

Download contacts	
Replace duplicate entries mode	Replace by name >
Download mode	http >
File encoding	UTF-8 >
Time intervals	None >
Download server	192.168.5.56
Username	Not configured
Password	Not configured

Figure 111: GXV34x0 Contacts – Download Contacts

## Search Contacts

1. Open Contacts.
2. Tap on the search field .
3. Enter a contact's name or a number to search. The search result will be automatically updated and displayed when entering the key words.

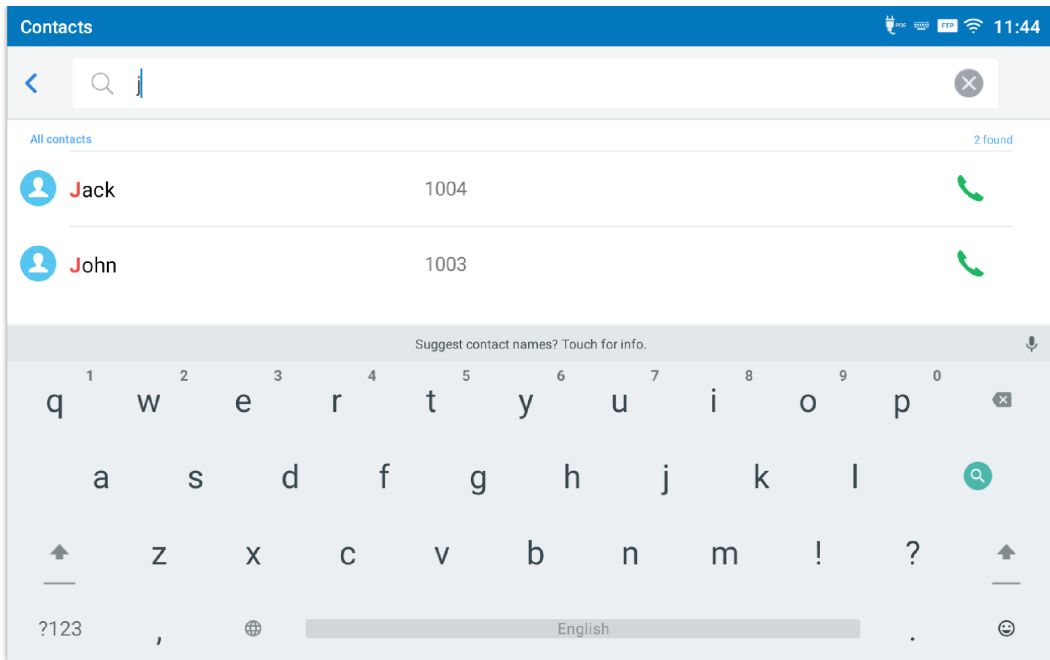



Figure 112: GXV34x0 Contacts – Search Contacts

## Use Contacts

Once the contacts are added, users could navigate in the contacts list  to make a call and manage the contacts furthermore.

## Make a Call to Contacts

Scroll up/down to find the contact in the list and tap on  to call this contact.

## Select Contacts

1. Scroll up/down to find the contact in the list.
2. Touch and press on the contact for about 2 seconds to show more options such as Delete contact, add to blacklist etc.

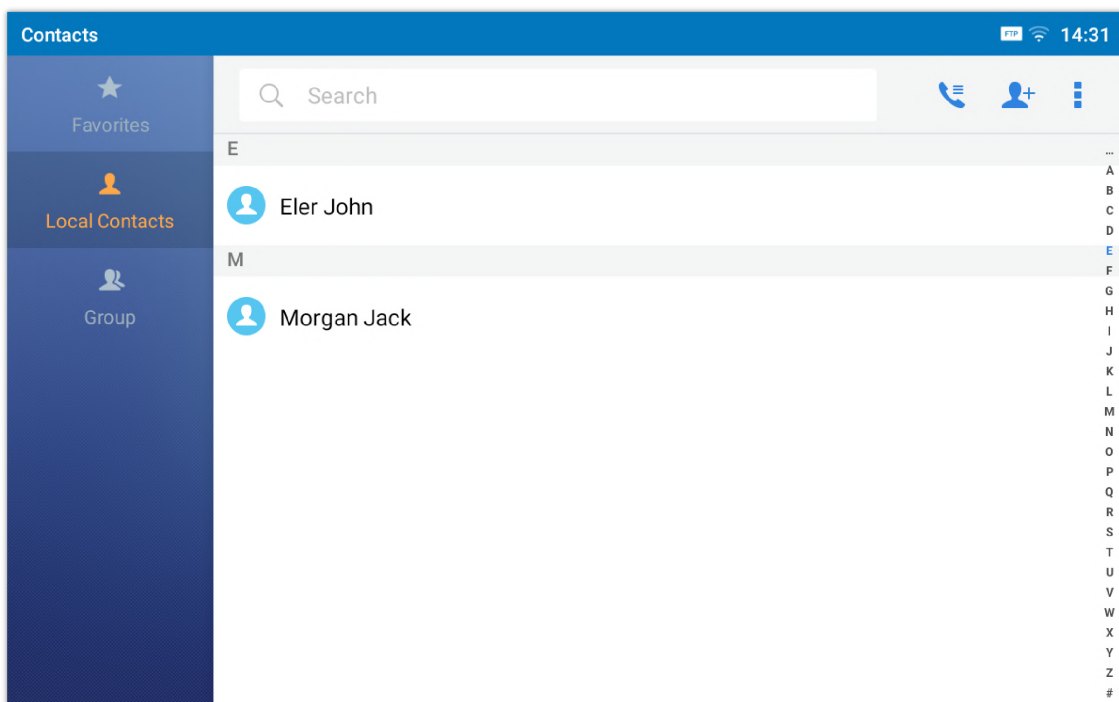





Figure 113: GXV34x0 Contacts – Select Contacts

## Add Contacts to Favorites

1. Select the contact/contacts to be added as described in [**Select Contacts**].
2. Then tap on  to add the contacts selected to Favorites

There are two other methods to add contacts to favorites.

- Directly pressing on the contact and tap on  to add the contact to favorite.
- Tapping on “Favorites” on the Contacts screen to navigate to favorites category and tap on  to select the contacts to be added to favorites then tap on .

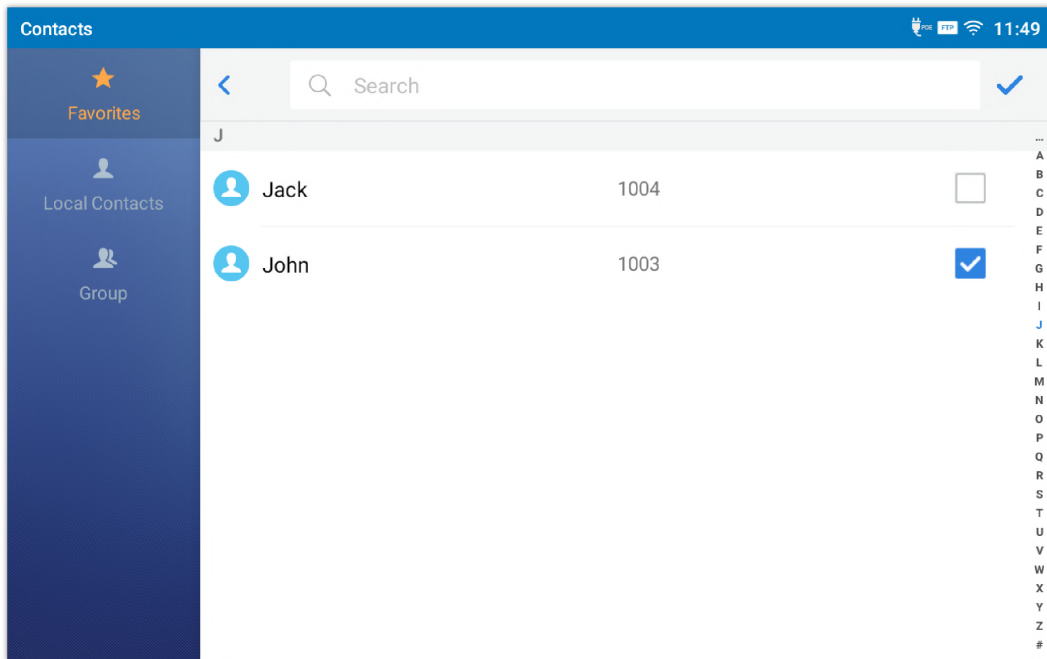



Figure 114: Add Contacts to Favorites

## Edit Contacts

1. Tap on a contact from the contacts list
2. Tap on  to edit the contact.

## Send Contacts to Desktop Shortcut

1. Long press on the contact
2. Tap on Send to Desktop from the menu.

## Share Contacts Via Bluetooth

Users can share a single contact or a batch of contacts. Refer to the following steps to do so:

- **Sharing a single contact:**
  1. Long press on the contact
  2. Select “Send” from the menu then choose the Bluetooth device that you want to share the contact with.
- **Sharing a batch of contacts:**

1. Select the contacts as described in [**Select Contacts**].
2. Press on  to share the selected contacts via Bluetooth

## Add Contacts to Blacklist

Users can add a single contact or a batch of contacts to the black list. Refer to the following steps to do so:



- **Add a single contact to black list:**

1. Long press on the contact
2. Select "Add to Blacklist" from the menu.

- **Add a batch of contacts to black list:**

1. Select contacts as described in [**Select Contacts**].
2. Press on  to add the selected contacts to the blacklist

## Add Group

Open Contacts and tap on  to access "Group". To add a new group, tap on  and name the new group.

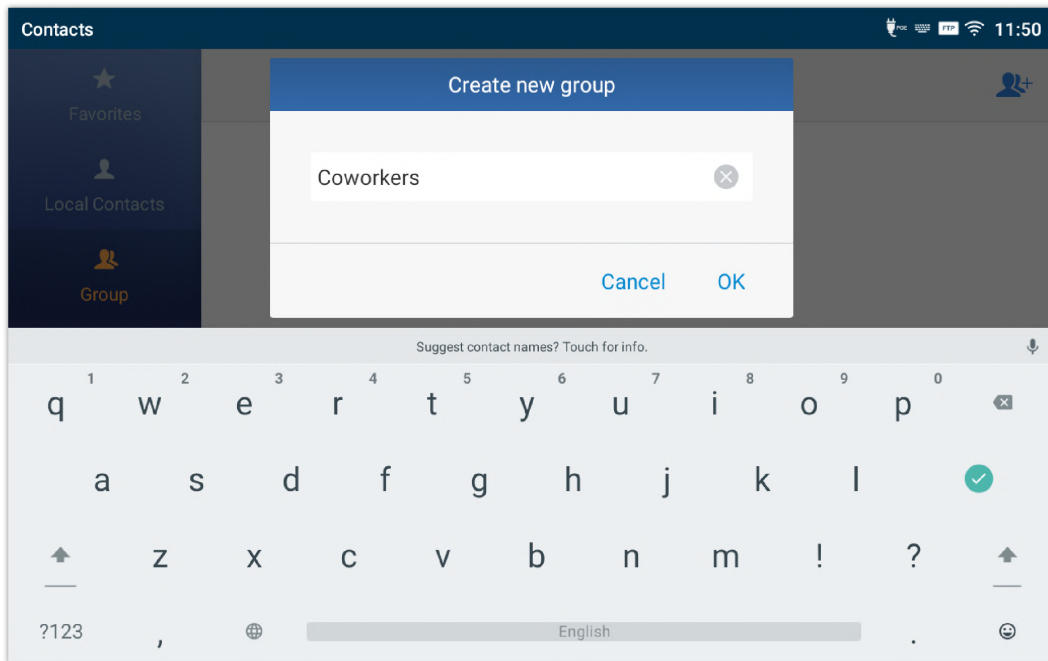

Figure 115: GXV34x0 Contacts – Add New Group

## Add contacts to Group

To add contacts to a group, tap on the group then tap on , check the contacts to be added to the group and press



### Note

- Users could also select a group for the contact when adding or editing the contact.
- Ringtone can be assigned in group as well as single contact. If the group has ringtone set to "Custom Ringtone", this ringtone has the highest priority when there is an incoming call to the contact.

## Contacts Storage Status

The GXV3480 default maximum contacts storage is up to 2000, while the GXV3470 and GXV3450 is up to 1000.

To check contact storage status, tap on More on the upper right corner of the contacts screen  to bring up contacts options, scroll down and select "Storage Status".

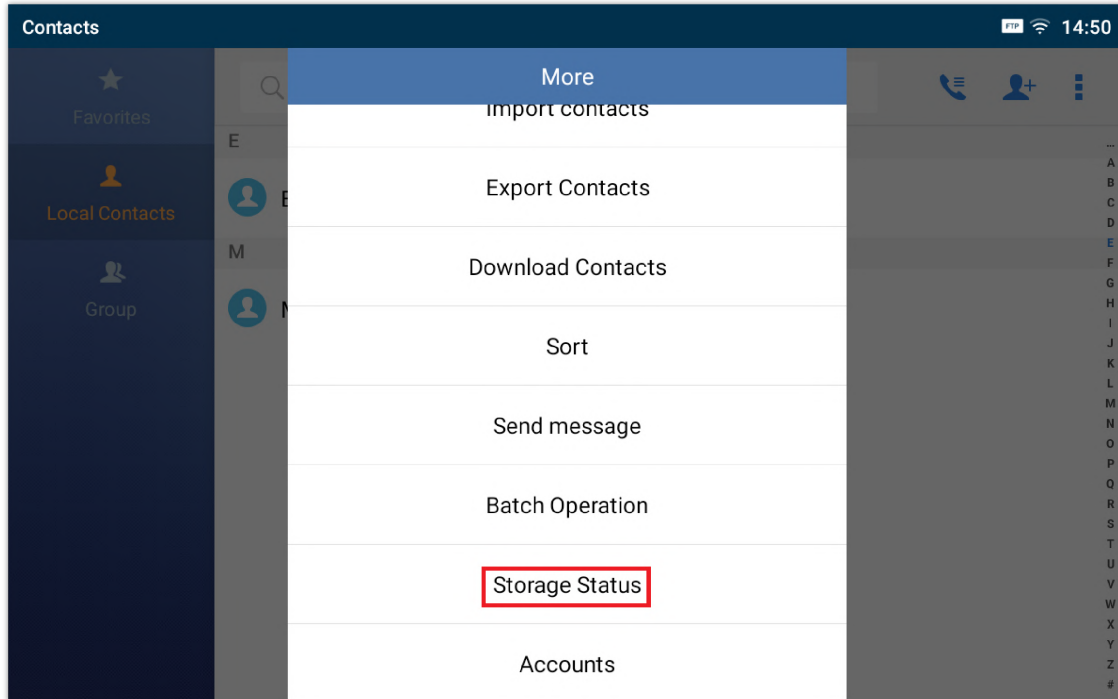

Figure 116: GXV3480 Contacts – Storage Status

### Note

Users could increase the number of maximum contacts storage to more than the default value. Users may access the phone through SSH and change the P value P1688 to another number ( $\leq 10000$ ) to increase the default contacts storage. In this case, if users increase this default P value, the phone resource will be cost, and the phone performance will be slower.

## Diagnostics

Diagnostics app provides visual information about the device's interfaces connection, Network and accounts status. Users can also perform an Audio diagnostic test to check if the built-in speaker is working.

Users can access the Diagnostics app and press on Start to check the phone's status.

- **General Status:**

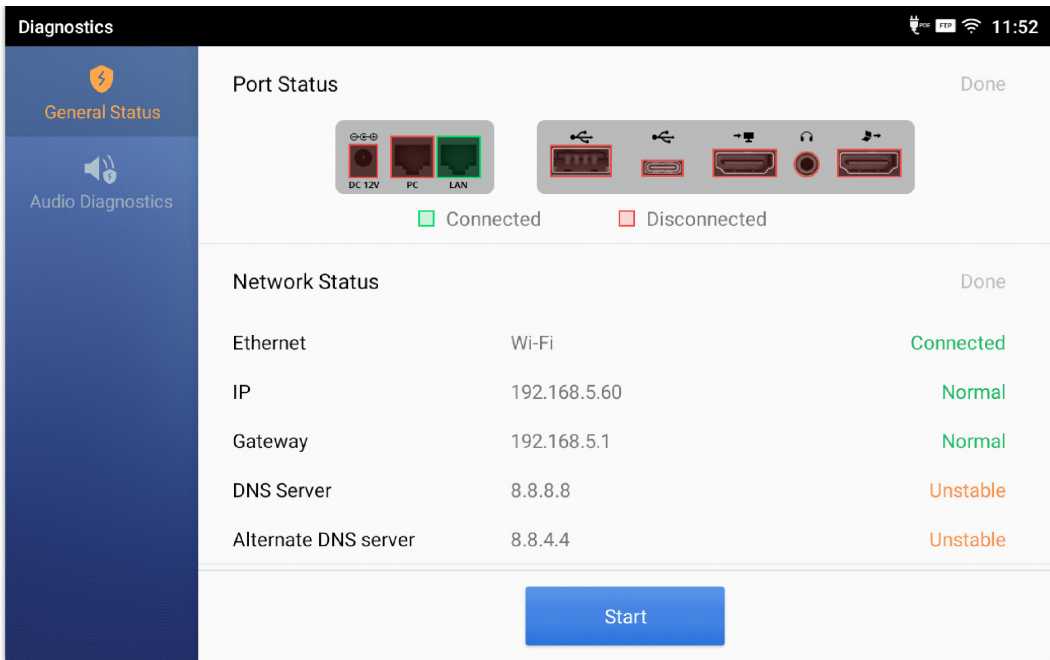

Figure 117: GXV 3480 Port & Network Status

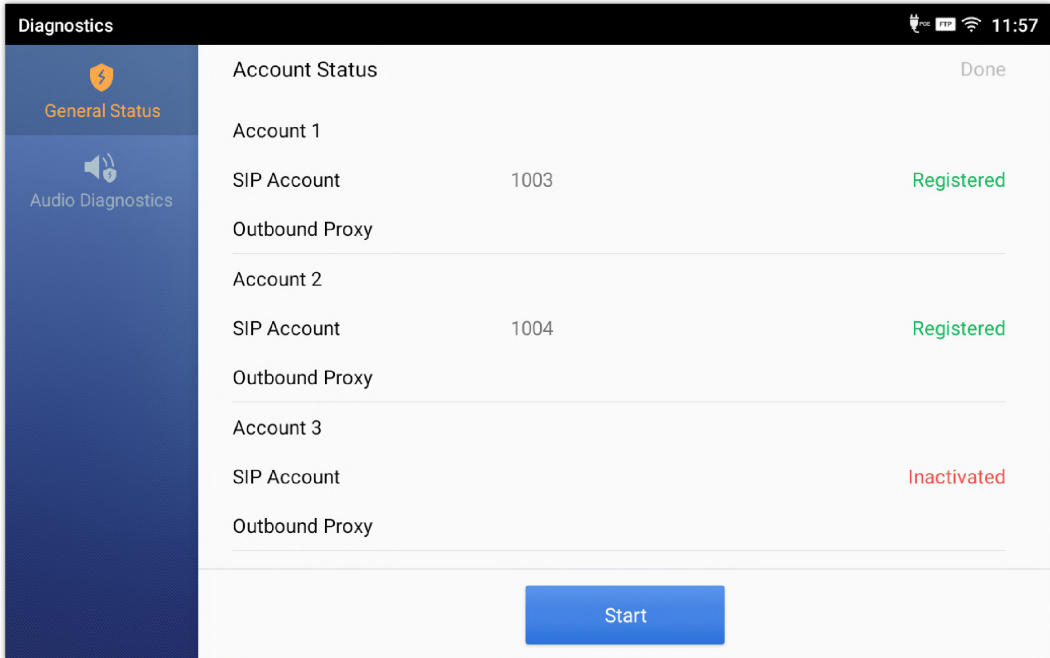

Figure 118: Account Status

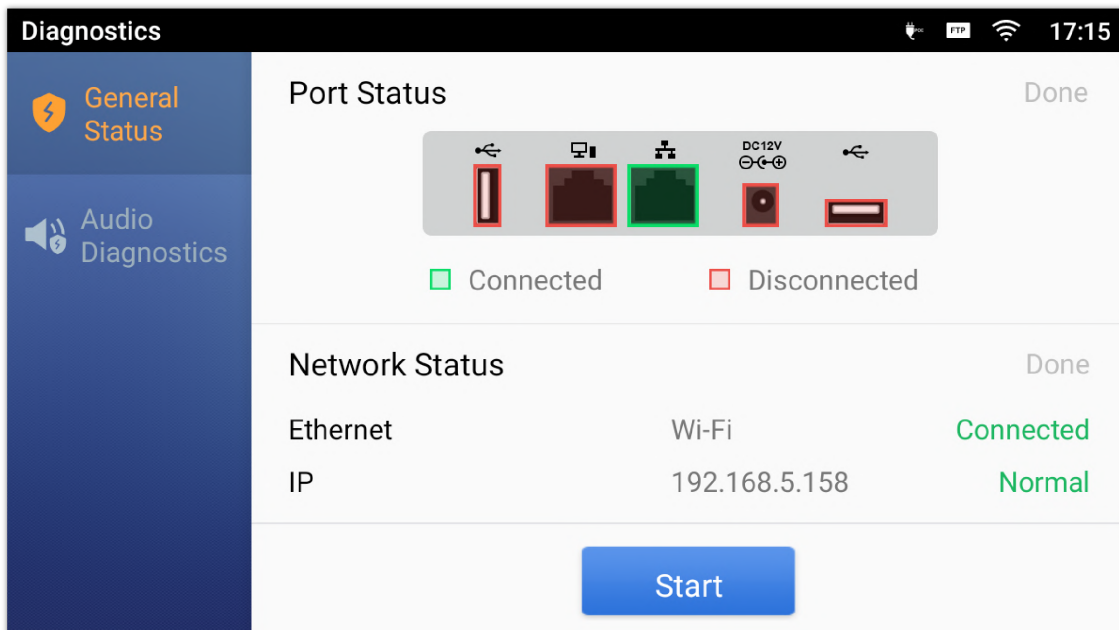

Figure 119: GXV 3450 Port & Network Status

- **Audio Diagnostics:**

In order to run the speaker diagnostics, Users need to press on Start and then listen to the recording. When then Users can indicate whether they could hear the audio recording and whether there was some noise heard.

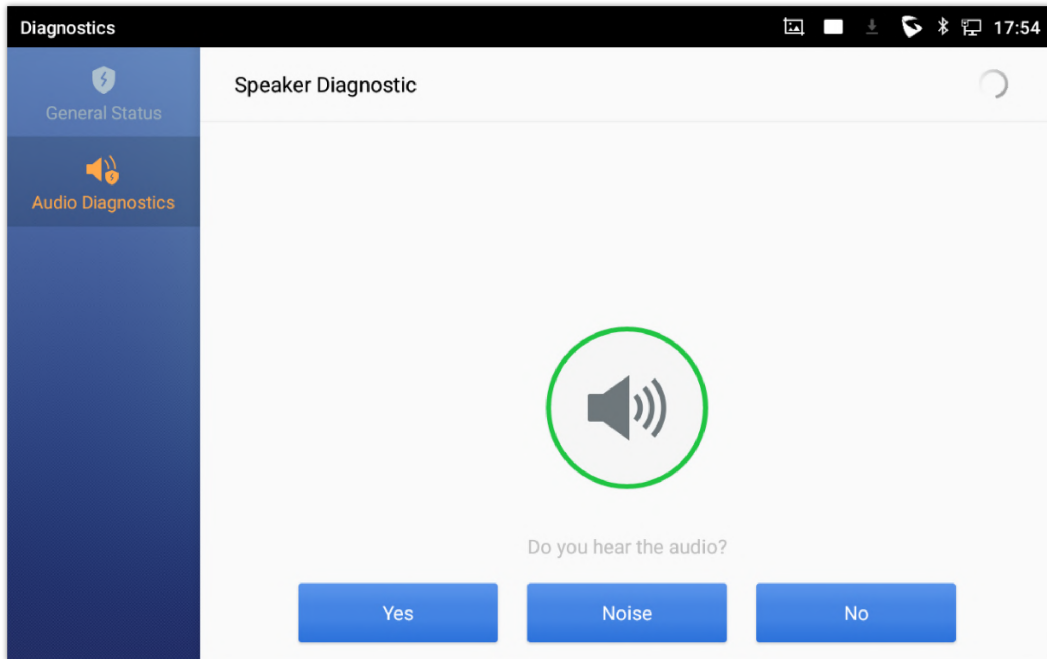
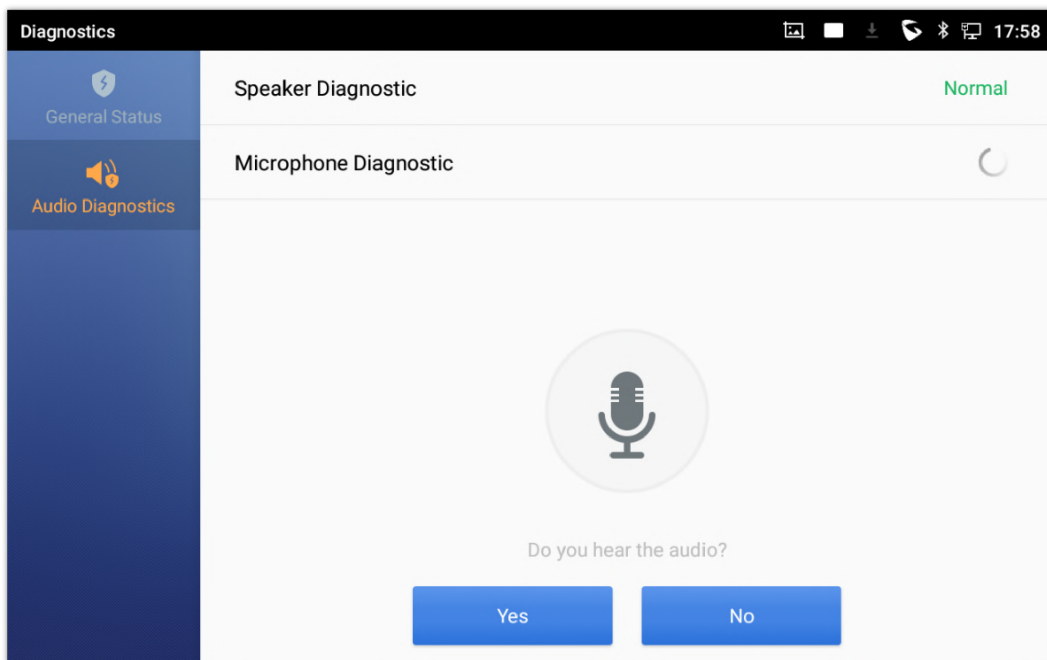

Figure 120: Speaker Diagnosis

When done with the speaker test, Users can Start the Microphone diagnostic which consists of speaking through the microphone after pressing on start and then checking If you can hear your speech back.



Microphone diagnosis

## One-key debugging

the One-Key debugging feature on the GXV34xx allows the users to collect information for troubleshooting purposes from the LCD screen , to perform the one-key debug:

- From LCD, Access Settings => Advanced => Systems Maintenance => One -key Debug,





- After inputting admin password, the debug will start automatically.

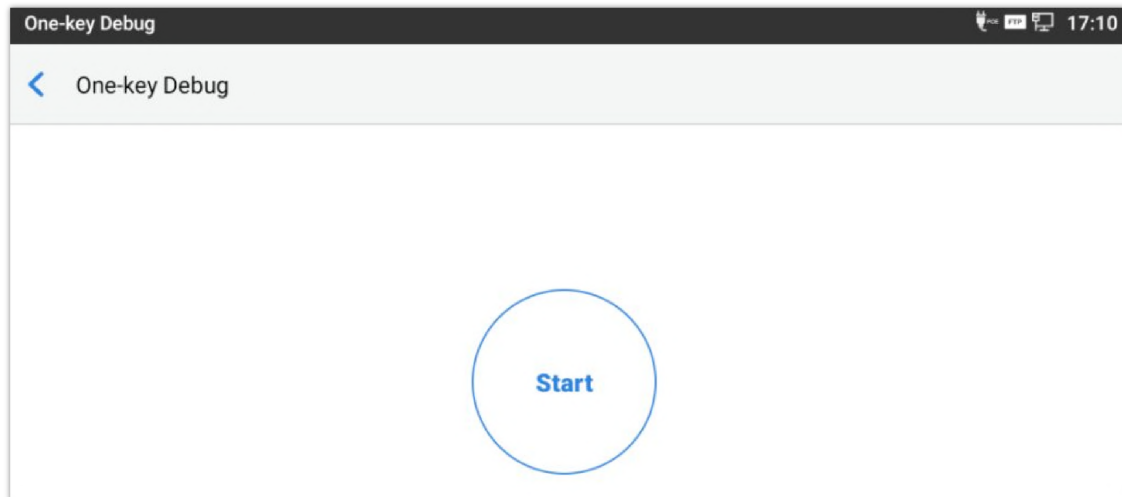

- You can stop the debug once the tests have been completed.

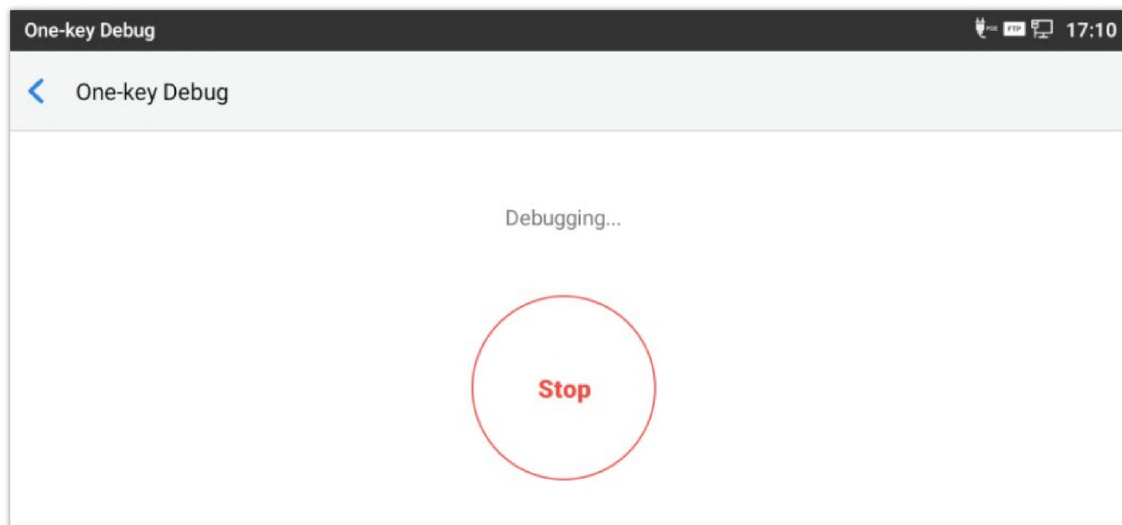

- The debug file can be found in File Manager => All tabs => internal Storage => Debug Info folder.



## GXV34x0 SETTINGS

Users could access the GXV34x0 Settings by tapping on the icon .

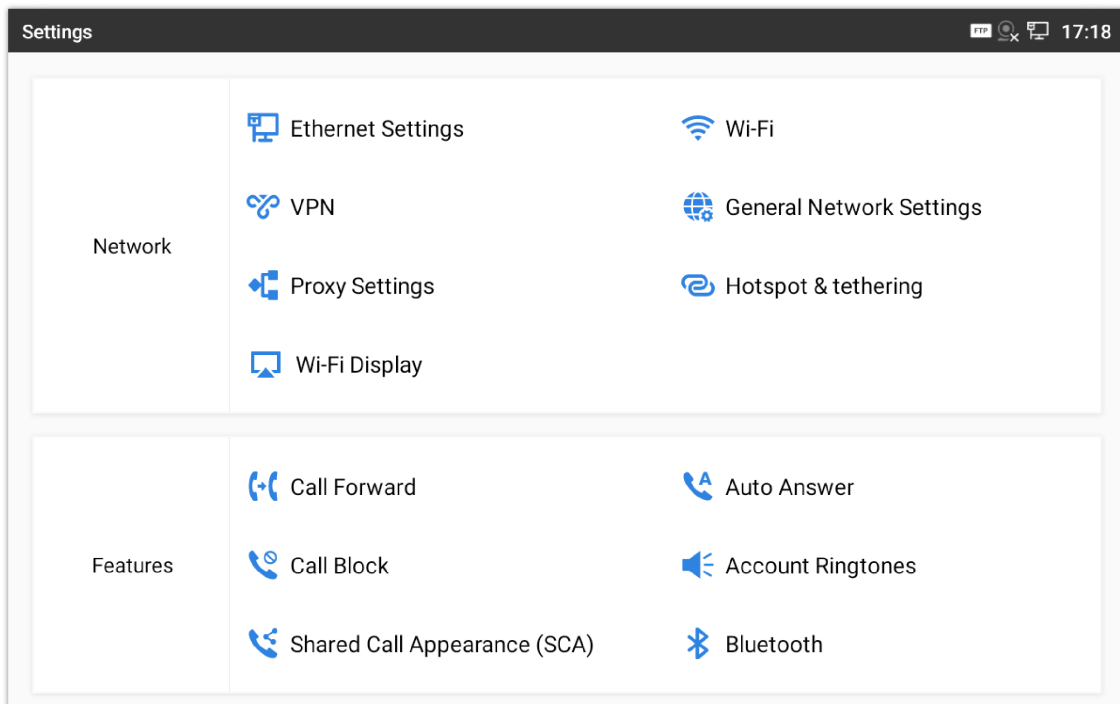

GXV3450/GXV3480 Settings

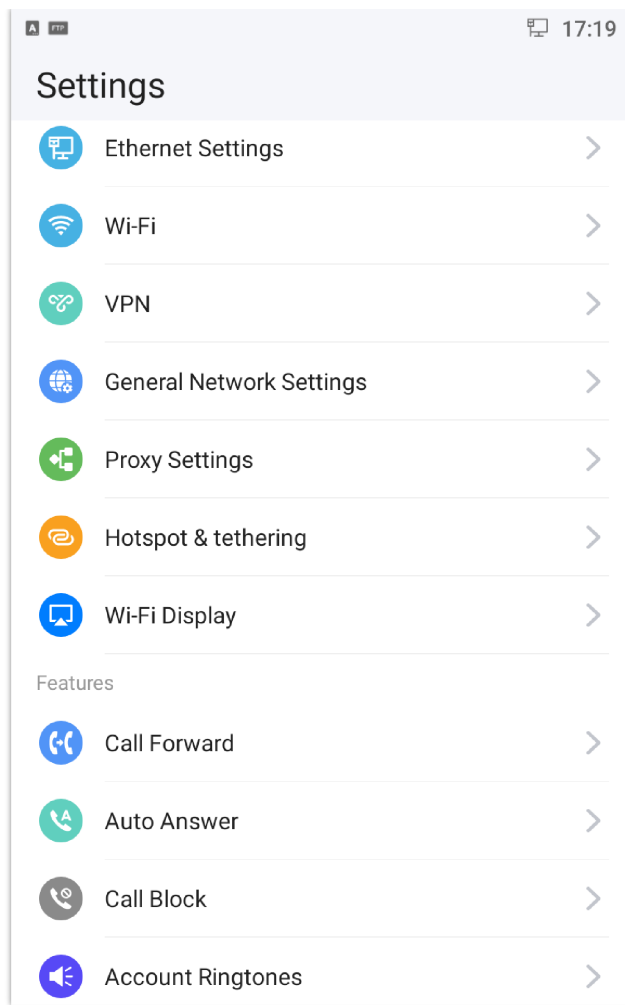

GXV3470 Settings

Users can find all the features and options that require configuration. Please, refer to the following table to have a clear idea about all the options available under this section:

<p><b>Features</b></p>	<ul style="list-style-type: none"> <li>● Call forwarding</li> <li>● Call Block</li> <li>● Shared Call Appearance (SCA)</li> <li>● Auto Answer</li> <li>● Account Ringtones</li> <li>● Bluetooth</li> </ul>
<p><b>Network</b></p>	<ul style="list-style-type: none"> <li>● Ethernet Settings</li> <li>● VPN</li> <li>● Proxy Settings</li> <li>● Wi-Fi</li> <li>● General Network Settings</li> <li>● Hotspot &amp; tethering</li> </ul>
<p><b>Basic</b></p>	<ul style="list-style-type: none"> <li>● Sound</li> <li>● Language &amp; Keyboard</li> <li>● Display</li> <li>● Date &amp; Time</li> <li>● Security Settings</li> <li>● Peripherals</li> <li>● Accounts</li> <li>● Power Information</li> <li>● Reboot the phone</li> <li>● Accessibility</li> </ul>

<b>Apps</b>	<ul style="list-style-type: none"> <li>• Application Management</li> <li>• Default Application</li> <li>• Notification Center</li> </ul>
<b>Advanced</b>	<ul style="list-style-type: none"> <li>• Account Settings</li> <li>• System Updates</li> <li>• Syslog</li> <li>• System Security</li> </ul>
<b>Status</b>	<ul style="list-style-type: none"> <li>• Account Status</li> <li>• Network Status</li> <li>• System Info</li> <li>• Storage Status</li> </ul>

Table 22: GXV34x0 Settings options

## Call Block

The GXV34x0 has blacklist support for users to manage incoming calls. To access blacklist, tap on “Settings” icon then under “Features”, access “Call Block”.

### Blocked Contacts

The blocked Contacts are the contacts that were added to the blacklist, the GXV34x0 will block any calls coming from these contacts. To show the blocked contacts tap on Blacklist from the Call Block page.

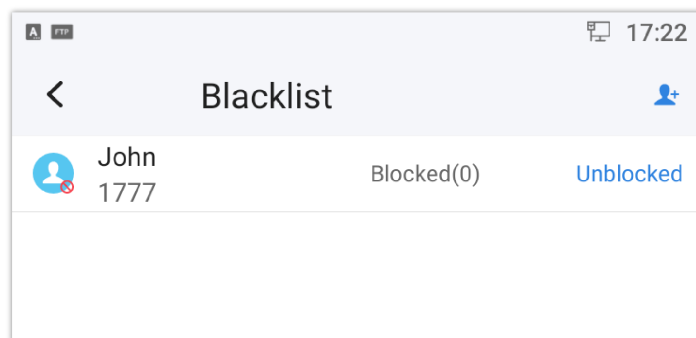

Figure 124: GXV3470 List of blocked contacts

### Block History

To show the history of blocked contacts/numbers, tap on call history from home screen then on “Block”.

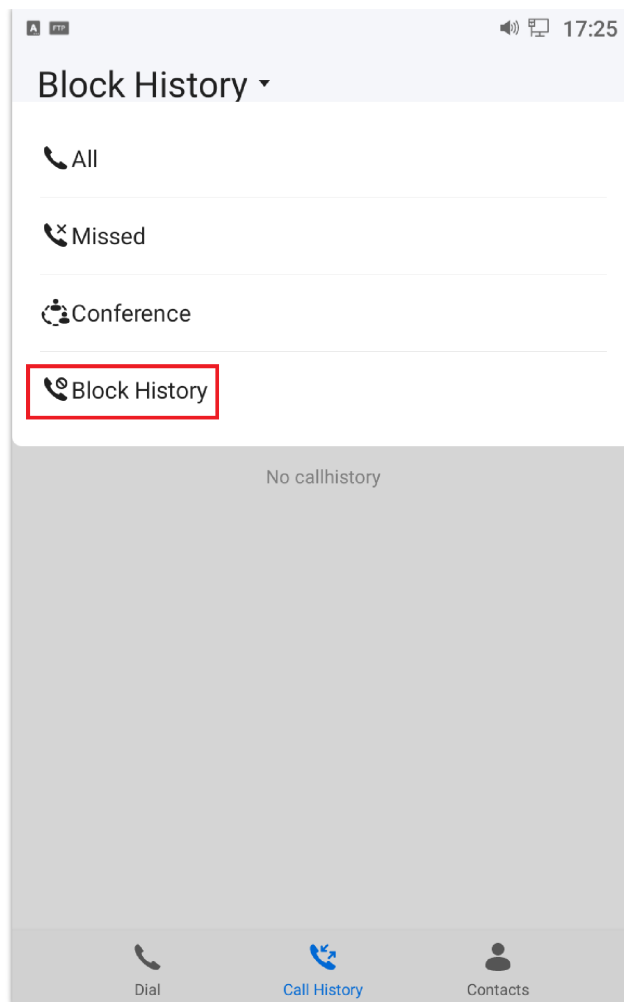



Figure 125: Block History

## Delete Block History

1. In the block history, tap on the recycle bin icon  .
2. Confirm the deletion of the complete blocking record by pressing "OK"

## Edit Blacklist

Tap on Blacklist under the Harassment Interception Menu to show the blacklisted contacts

- o **Add number to blacklist**

1. Tap on  to start adding new entry to the blacklist. The blacklist can be added manually, from contacts, or from call history.

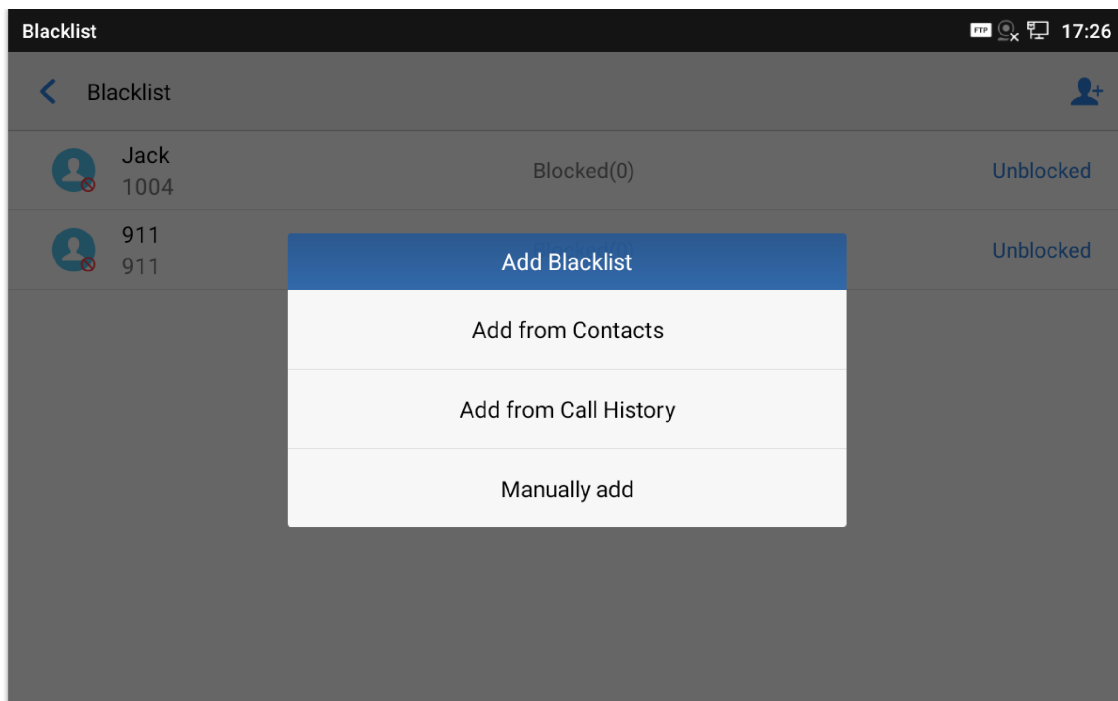

Figure 126: GXV34x0 Blacklist – Add Number to Blacklist

2. The following figure shows manually adding number to blacklist. Once **Manually add** option is selected, a window will be prompted for users to enter the phone number in the first field and name/note in the second field (optional). Tap on **OK** to finish the adding operation.

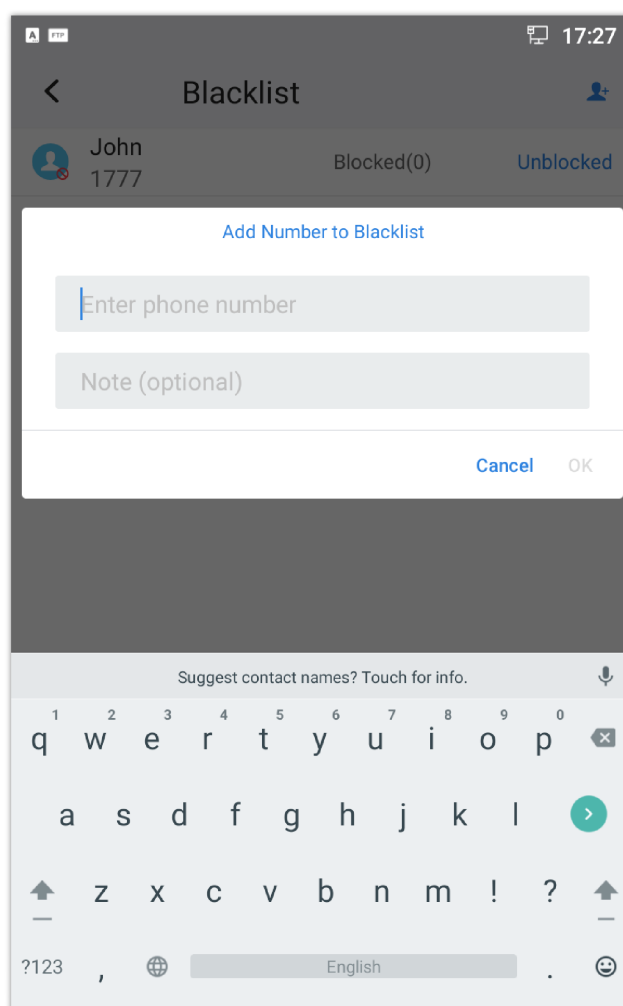

Figure 127: GXV3470 Manually Add Number to Blacklist

#### o Edit Blacklist

1. In the blacklist, touch and press the entry for about 2 seconds a prompt allowing changing the name/note is displayed
2. Change the name/note.

3. Tap on OK once done.

- o **Delete Blacklist**

Users can Delete/unblock contacts from the blacklist using two methods:

1. From the blacklist menu press on "Unblocked" to no longer block the calls from coming from this contact.
2. From the contacts menu, long press on the contact and press "Remove from Blacklist".

## Block Anonymous calls

The GXV34x0 gives the possibility to intercept anonymous calls for each account registered:

1. Enter Call Block Menu.
2. Check **Block Anonymous Calls** as shown on the figure below.
3. Check the account to apply the interception.

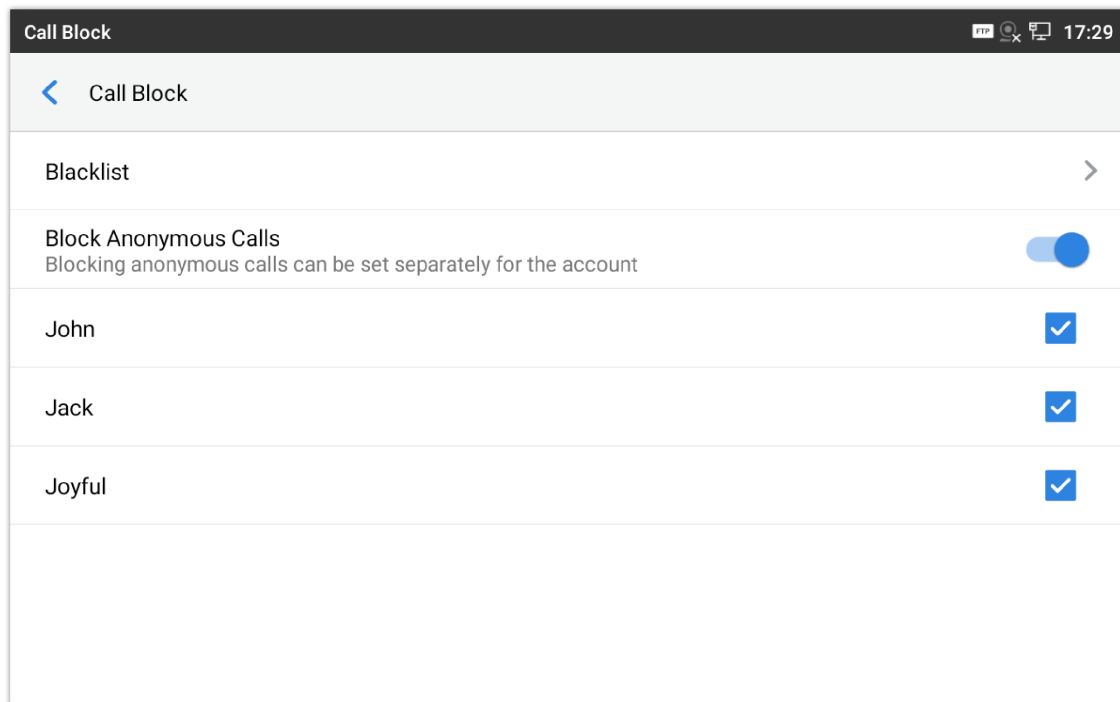



Figure 128: Intercept Anonymous Calls

## CALL HISTORY

The GXV34x0 supports local and BroadWorks Xsi Call history. Tap  on idle screen to access Call history. The following figure shows the call history on the GXV34x0.



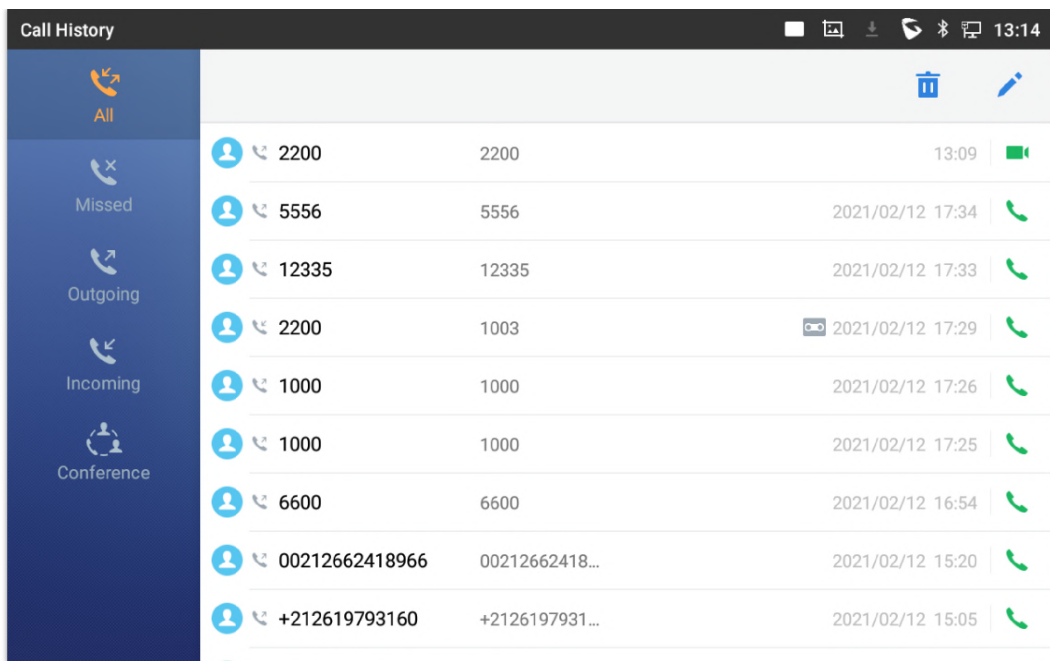

Figure 129: GXV34x0 Call History

## Local Call History

There are six different categories in the local call history. Users could tap on the icon on the top menu to access the corresponding call logs:

- All
- Missed
- Outgoing
- Incoming
- Conf History
- Block (if any)

## Dial Out from Call History

Tap on one of the call history entry to call this number directly. The phone will use the same account as the call log when dialing out.

## Call History Options

- Touch and press the call history entry for about 2 seconds until more option window pops up
- Users can edit this number before calling, add this number to contacts, add this number to blacklist etc...

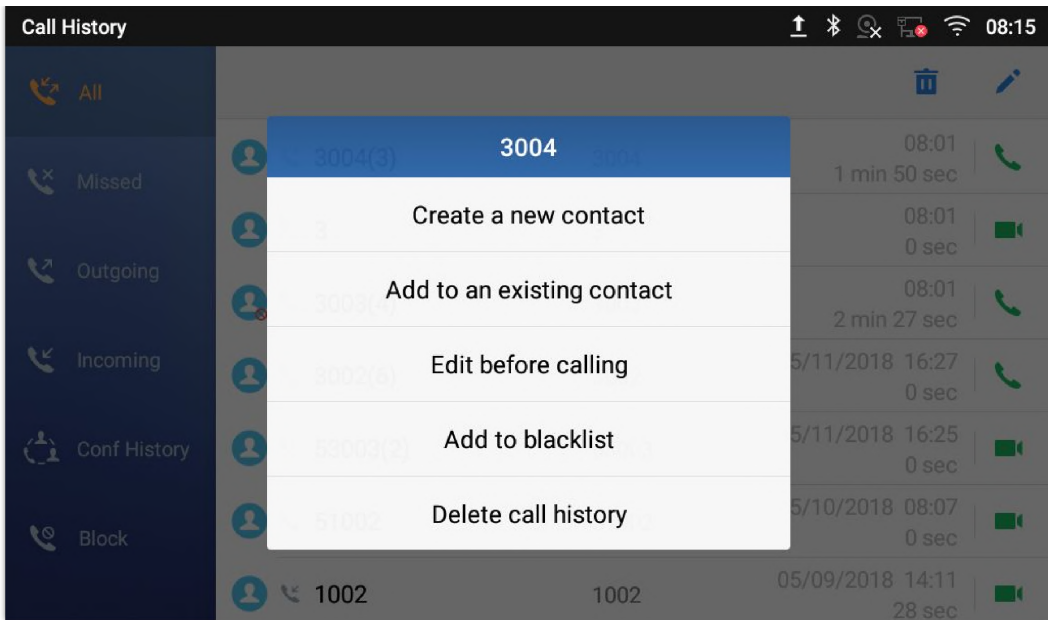



Figure 130: GXV34x0 Call History – Options

## Delete Call History



- **Delete the entire call history**

Users can delete the complete call history by pressing the  directly after accessing the call history page.

- **Delete a single call history entry**

Users can delete a single call history entry by pressing the entry for about 2 seconds to bring up the options then select Delete call history.

- **Delete multiple call history entries**

- Press on  the top right corner of the screen and select the entries to be deleted
- Tap on  to delete the entries.

## Call History Details

For each call history entry, users could tap on the entry to access the details.

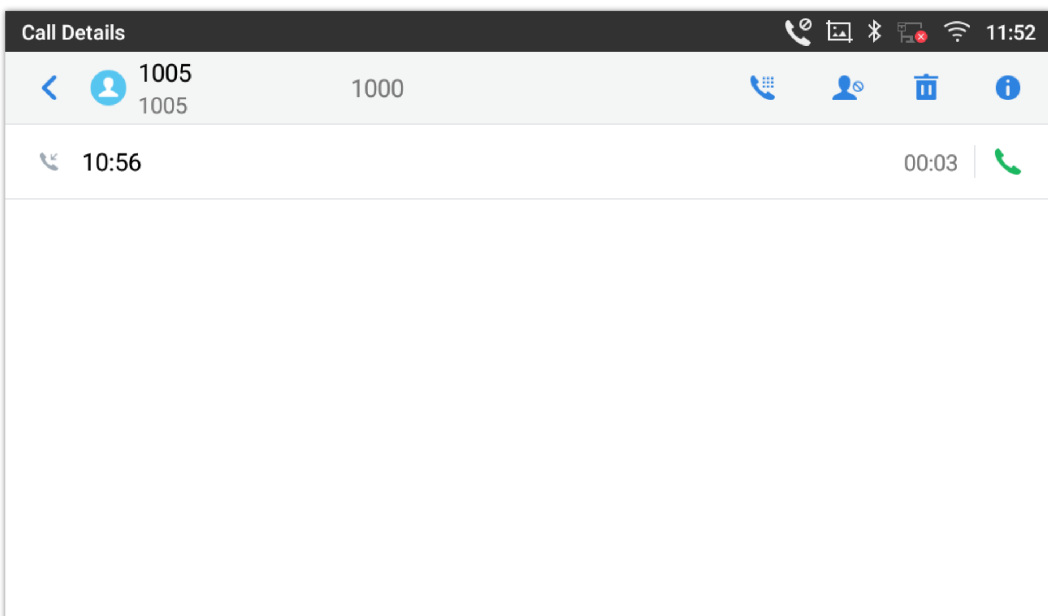

Figure 131: GXV34x0 Call History – Details





Users could find the following call details by tapping on the entry:

- **The Call date:** the time when the call was initiated.
- **The Call duration:** The period of time when the call was in progress.
- **The type of the call:** Specifying if the call was a Video or an Audio Call.

#### Note

Call details under conference history include the previous details of the conference and for each one of the participants.

The following operations could be done:

-  Dial out this number directly
-  : Bring up dial screen with the call history number. Users could edit the number before dialing out.
-  Add to Blacklist:
-  : Delete the entry
-  : Options ,“Create a New Contacts”, “Add to an Existing Contact”:

## SMS

The GXV34x0 has built-in SMS application to send/receive message, if the SIP server and the other party support SMS message. Users can create, edit draft, delete and check the storage status of SMS.

Tap on  from the phone’s desktop to launch SMS application.

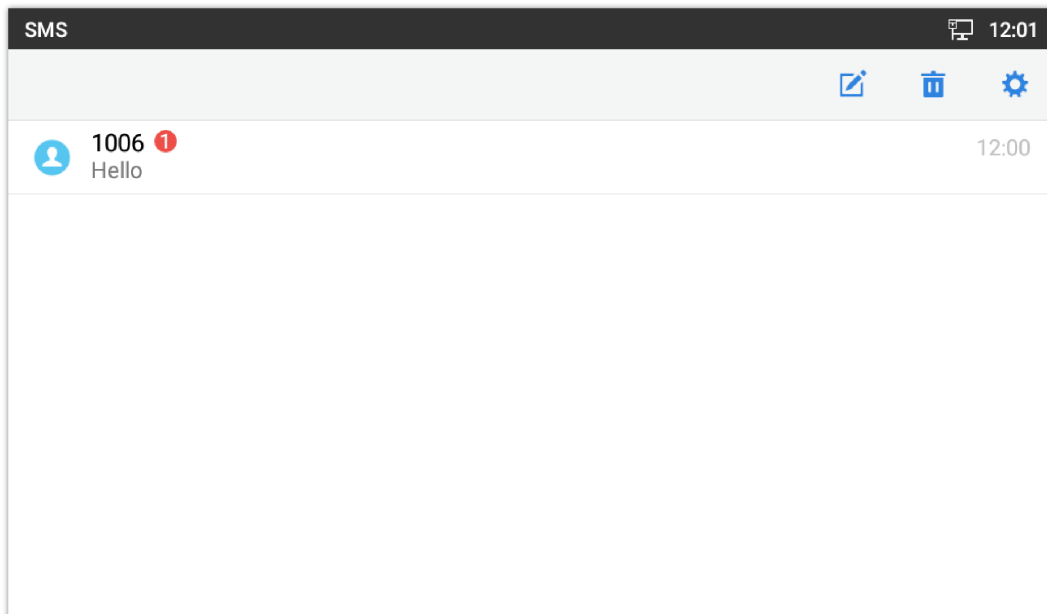

Figure 132: GXV34x0 SMS Message

### View SMS

On the SMS list screen, tap on one of the messages to view the SMS details.

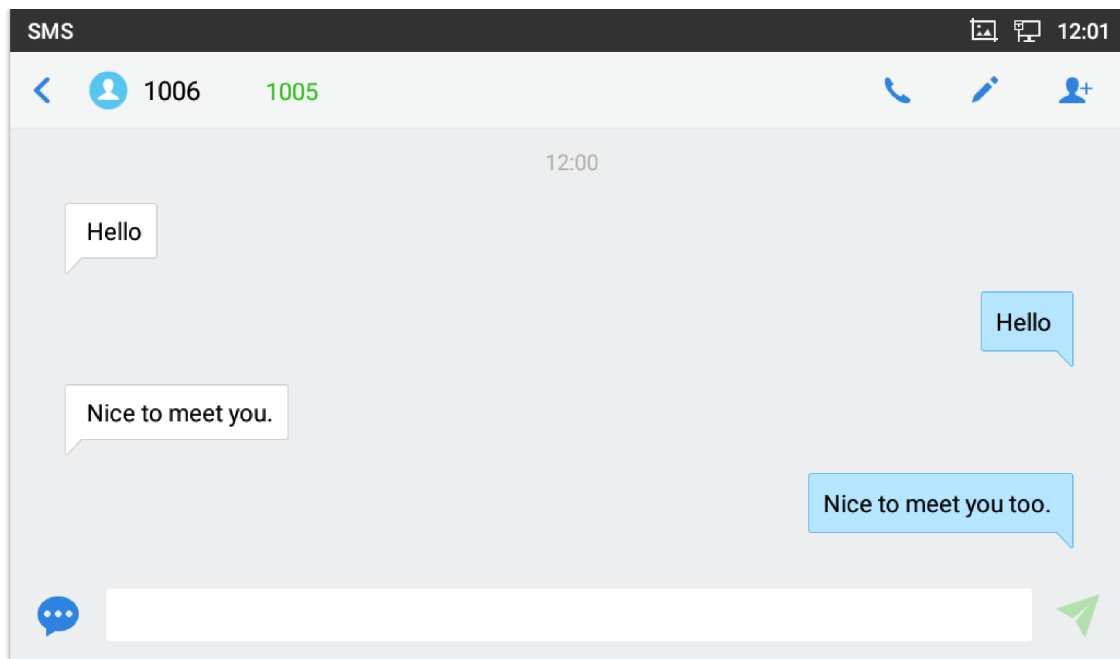





Figure 133: View SMS Dialog

- Users can press on  in order to make a call to the account's number on that conversation
- Users can press on  in order to "delete", "lock", "unlock" or forward a message or a batch of messages from the conversation.
- Users can press on  in order to add the number as a contact in the GXV34x0.

**Note**

GXV34xx video phone receives broadcast messages from UCM, and these messages can be accessed within the SMS app.

**Create New SMS**

Tap on  in SMS application to start composing a new message.

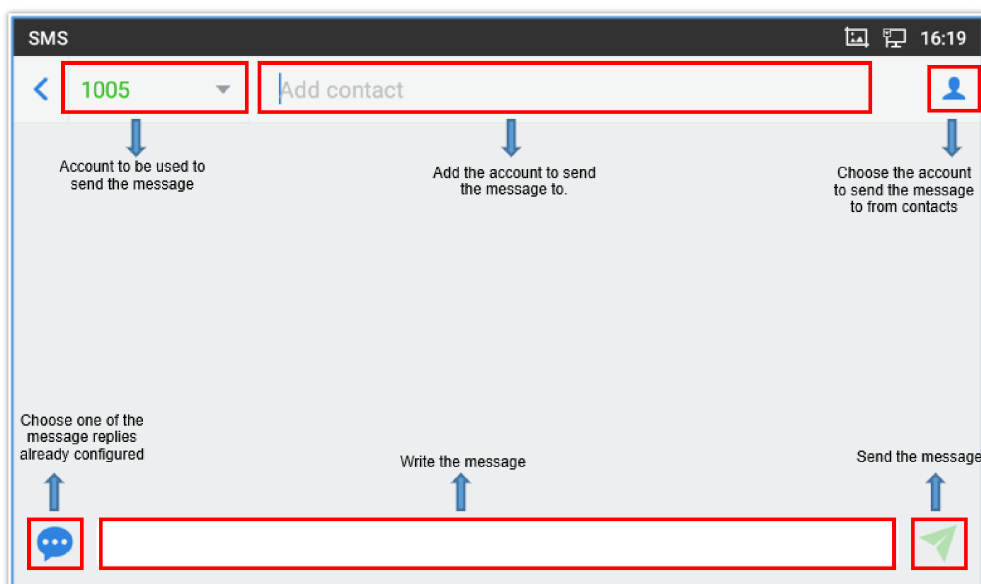



Figure 134: Create a New SMS

1. Select account to send the message from. (**Note:** Only registered accounts will be shown on the selection drop-down list, if you cannot find your account then make sure it's registered).
2. Enter the account number to send the SMS message to:
  - Add number to send the message to.
  - Enter the Number/Name of an existing contact to send the message.

- Users could also select contact from GXV34x0 Contacts by tapping on “Contacts” icon  on the upper right of the page. See Figure 89.

3. Input content: Enter the message content on the bottom field of the screen. Tap on “Done” from the Keyboard once finished.
4. Send message: Tap on the arrow icon when you are ready to send the message out.

## Delete SMS

1. Users can press and hold one SMS message in a conversation for about 2 seconds until a prompt appears where “Delete” can be pressed in order to delete the chosen SMS message.
2. In order to delete one conversation, users can press and hold the conversation for about 2 seconds until a prompt appears where “Delete” can be pressed in order to delete the chosen SMS message.
3. Users can delete a batch of conversations by pressing on , then the conversations can be selected in order to delete them by pressing the same icon.

## Send SMS from Contact APP

Starting from 1.0.1.18 version, user can send SMS straight from the Contact APP as follow:

1. Select one or Multiple contacts:

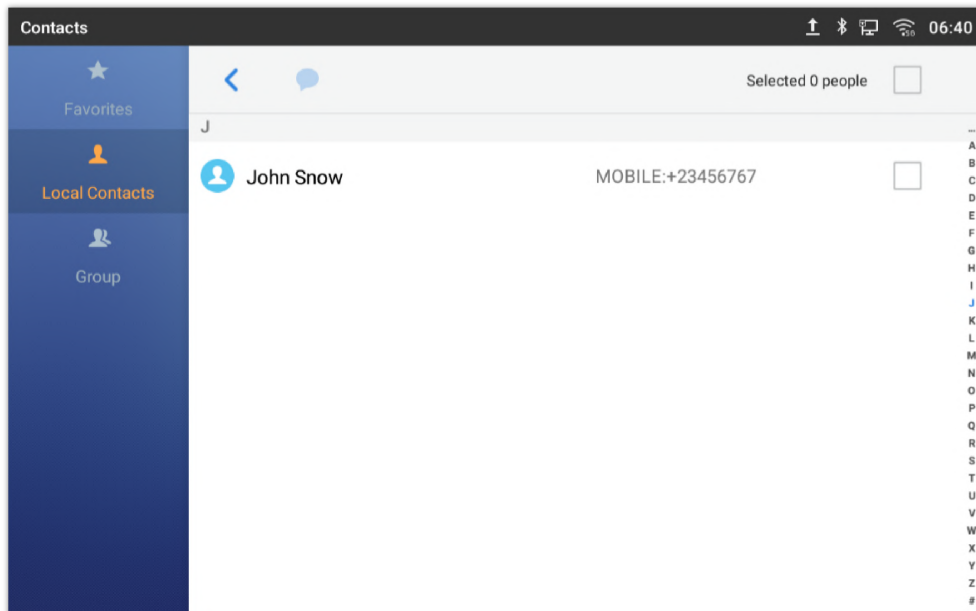

Figure 135: Select contact

2. Click on the Message icon :

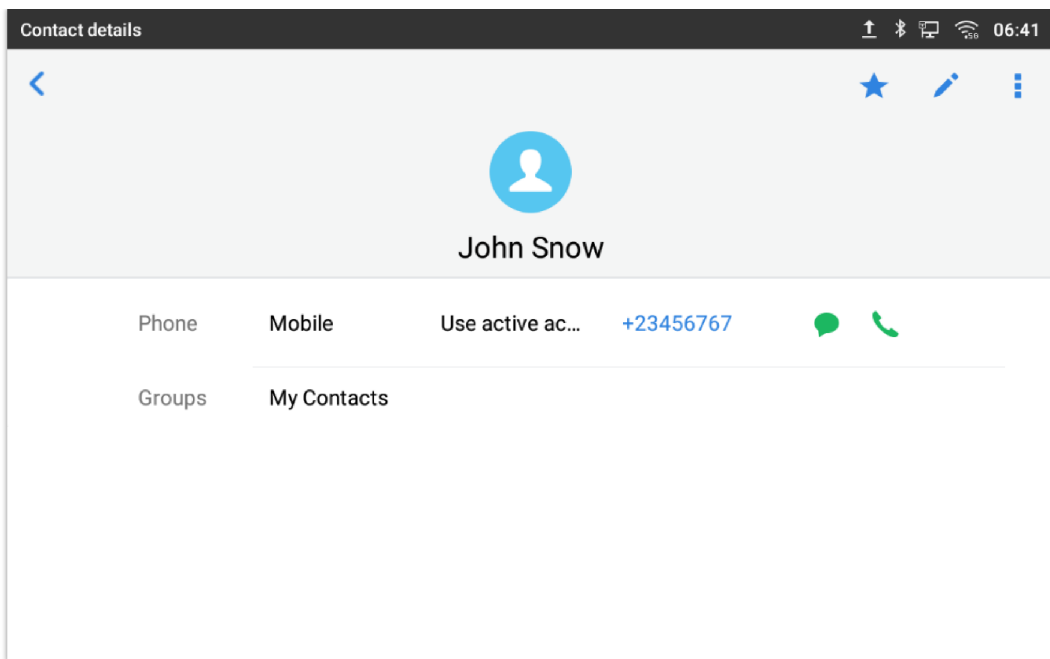



Figure 136: Click on Message icon

3. Type the message and then click send button :

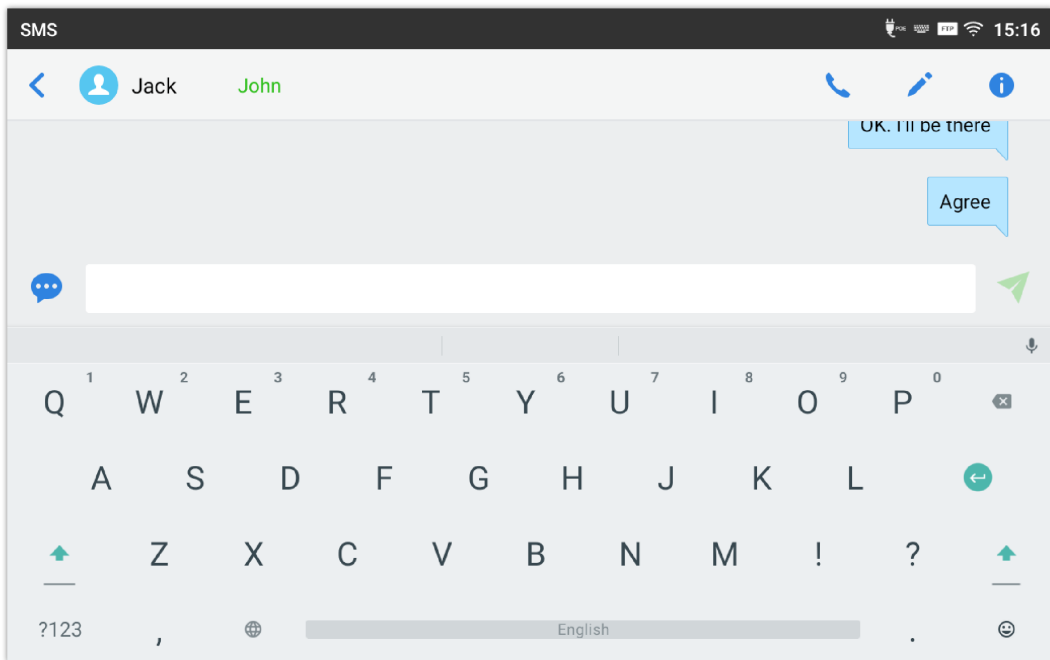



Figure 137: Type then Send Message

## SMS Settings

Users can verify the SMS Settings by pressing on "Settings" icon  from the conversations screen.

- **Storage Status:** The SMS app supports up to 1000 messages, "storage status" helps users to verify the current number of messages on the GXV34x0 and the storage space that still available.
- **Enable Quick Reply:** Enable this feature in order to automatically send a quick reply when an incoming call is rejected.
- **Choose a quick reply message:** Users can add more quick reply messages by clicking on , and choose the one that will be used and sent automatically when an incoming call is rejected.

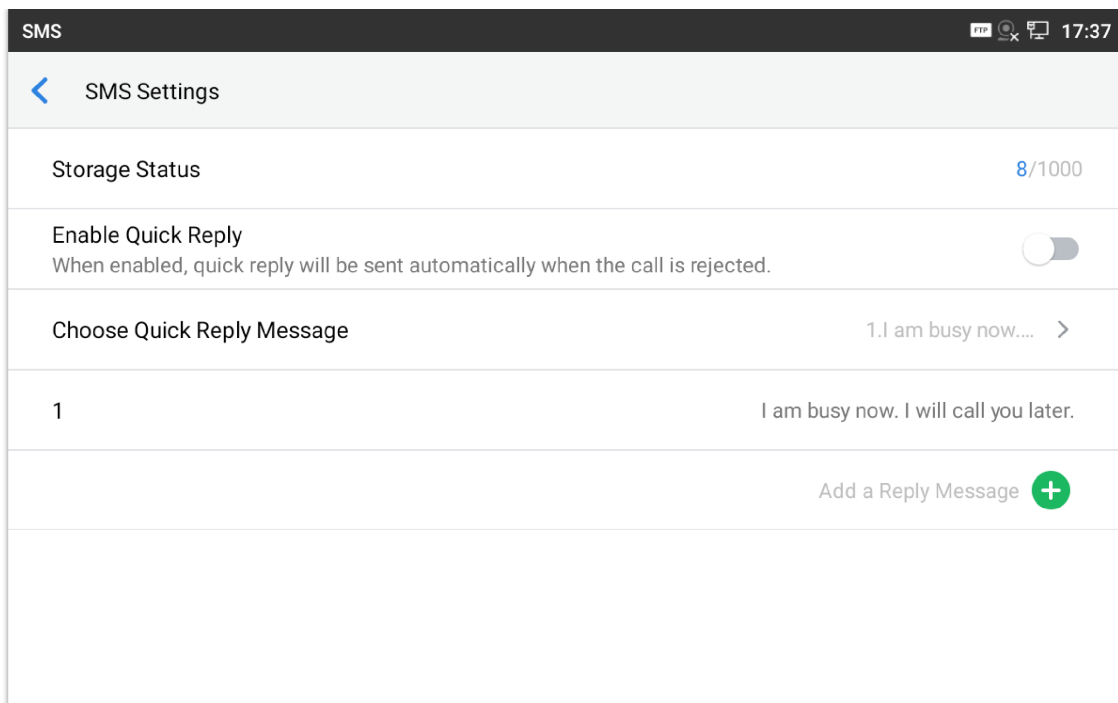



Figure 138: SMS Settings

## RECORDER

GXV34x0 Recorder application allows users to record audio and access recording files from call recordings. There is no time limit on the recorder as long as there is enough space to save the recording file. Tap  on the phone's desktop to launch the Recorder application.

### Call Records

During an active call, users have the option to record the conversation. The recorded conversation can be retrieved from the recorder application. The account and date are specified in each record's file name.

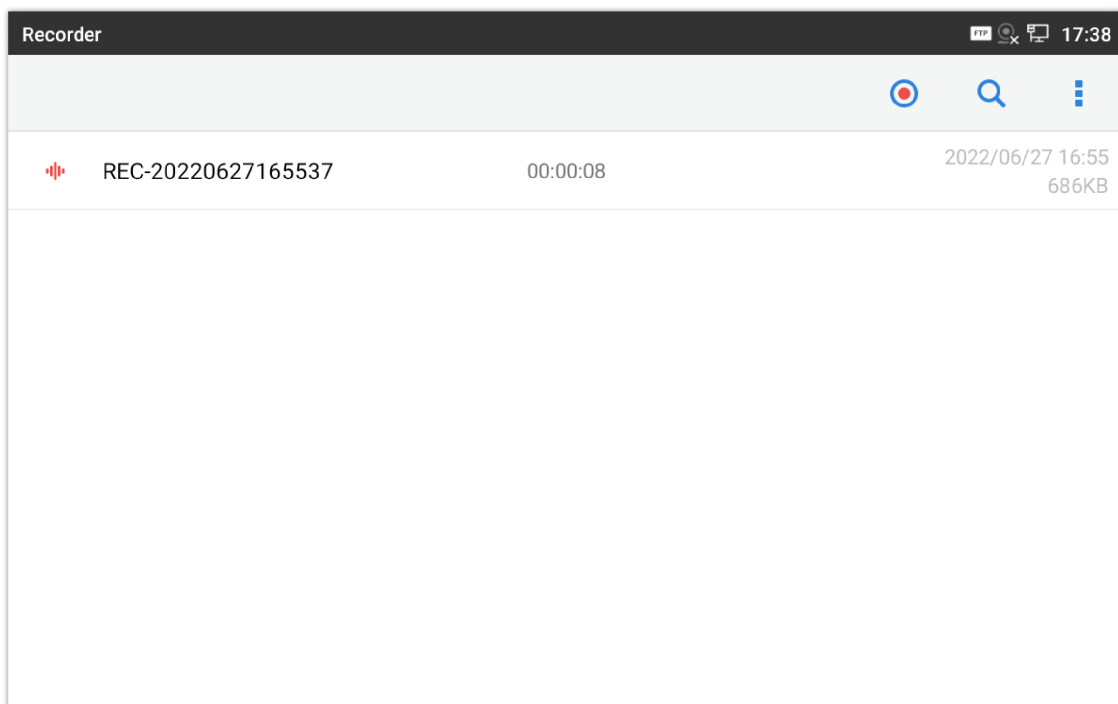





Figure 139: Recorder Application

### Audio Records

To use the recorder app to record audio, tap on  open the recorder.



1. Tap on  to bring the recording page

2. Tap on  to start recording.

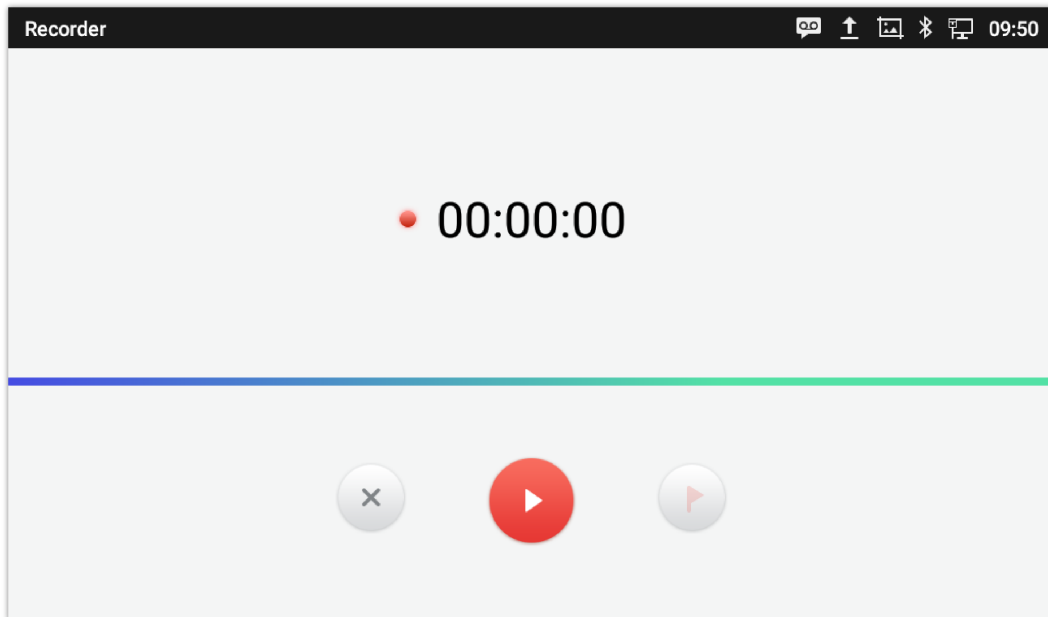



Figure 140: Recording Audio

3. Users can tap on  during the recording to mark a section of the conversation (a red flag will be displayed besides the record's file name to indicate that it's marked).

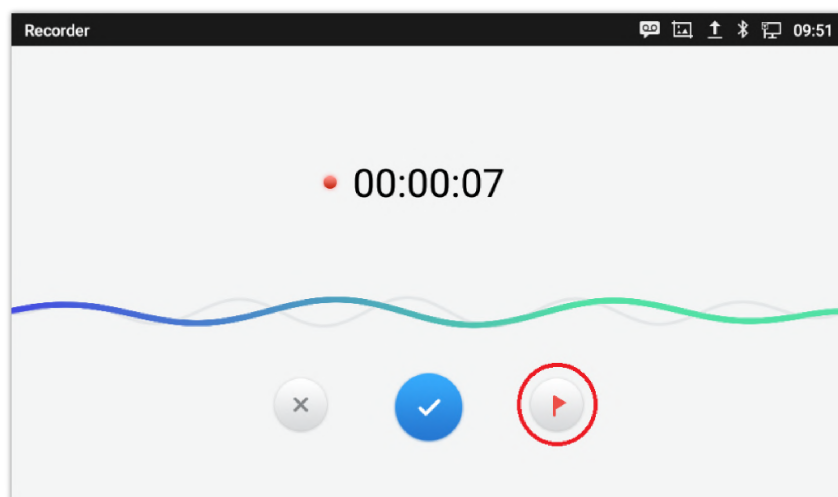



Figure 141: Flag Mark

4. Tap on  to cancel the recording, or on  to end the recording. The file will be saved and accessible under Recorder application. Users can tap on the recording file to play the recording.

Recorder			
			09:51 1.6MB
REC-20190212095059	00:19		09:51 1.6MB
REC-20190212094301	00:08		09:43 736KB
REC-20190212091234	00:05		09:12 424KB
2000-20190212091151	00:05		09:11 41KB
2000-20190212091134	00:07		09:11 54KB

Figure 142: Recorded Files

## Recorder Settings

User can view the information about storage status, Enable/Change a password for accessing the Recorder application by tapping on  followed by **Settings**:

1. From the phone's desktop page click on  to open the recorder.

Recorder			
			09:51 1.6MB
REC-20190212095059	00:19		09:51 1.6MB
REC-20190212094301	00:08		09:43 736KB
REC-20190212091234	00:05		09:12 424KB
2000-20190212091151	00:05		09:11 41KB
2000-20190212091134	00:07		09:11 54KB

Figure 143: Recorder Menu

2. Click on **Menu** icon on the top right as shown above
3. Tap on **Settings**

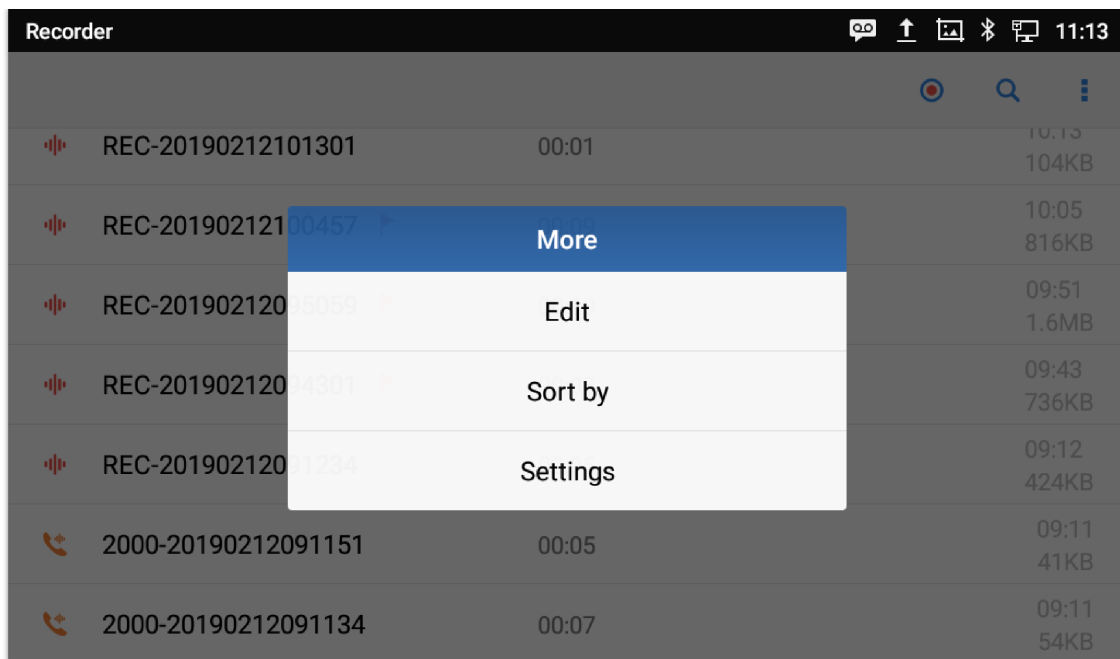

Figure 144: Menu Options

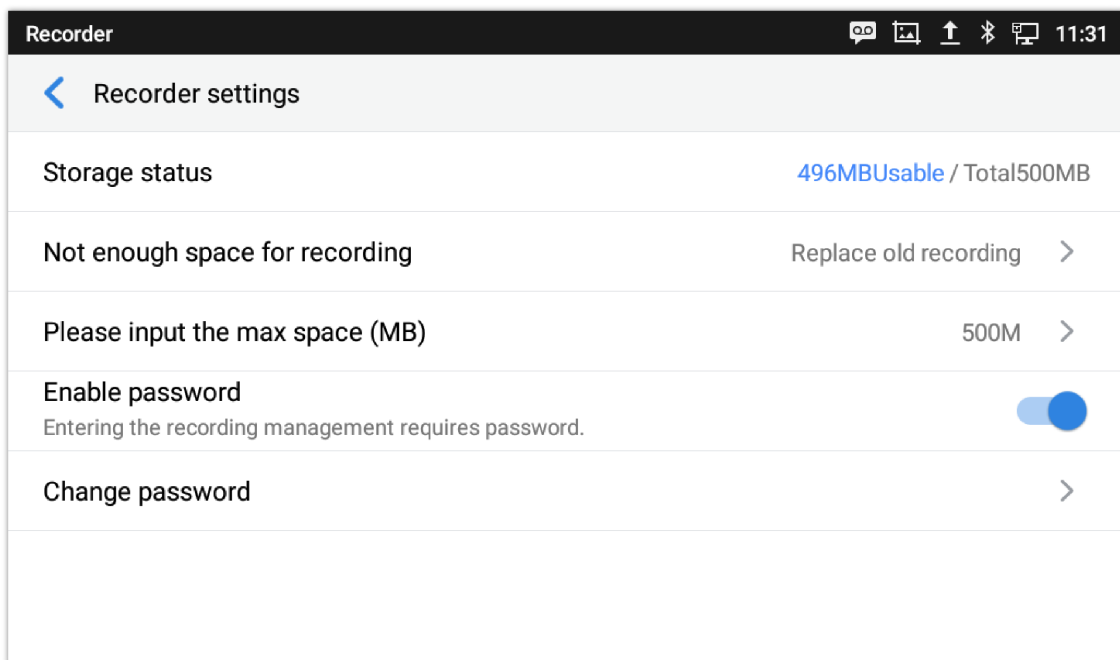

Figure 145: Recorder Settings

4. Users can enable and choose a password to be set for accessing the Recorder application by tapping on **Enable Password**:

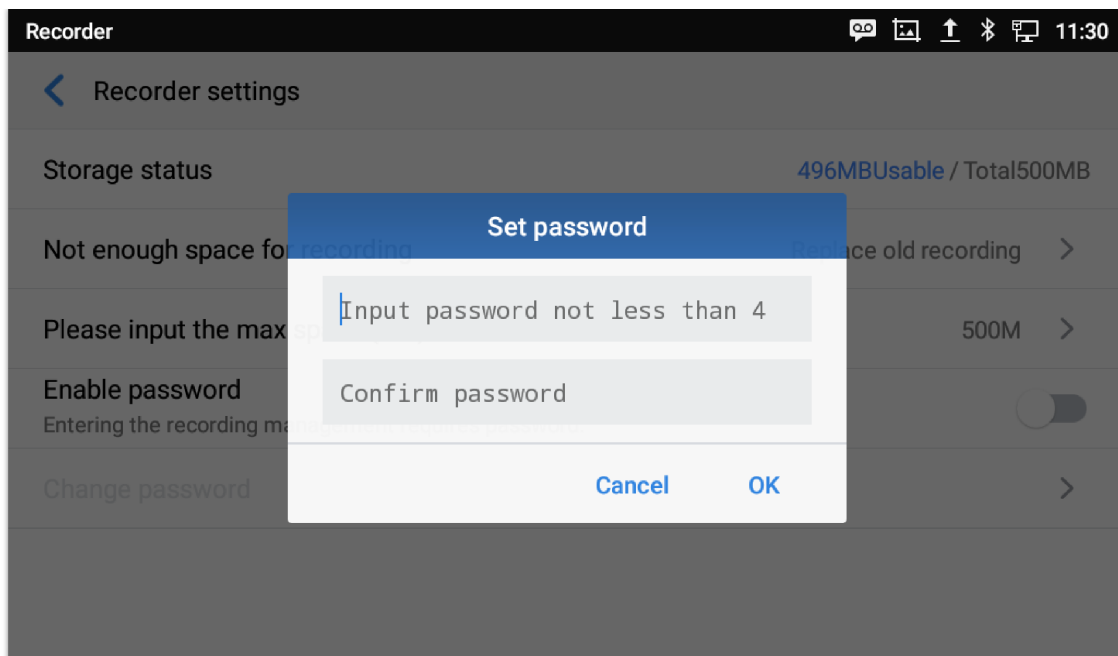

Figure 146: Set Password

5. Users can change the preconfigured password by tapping on **Change password**:

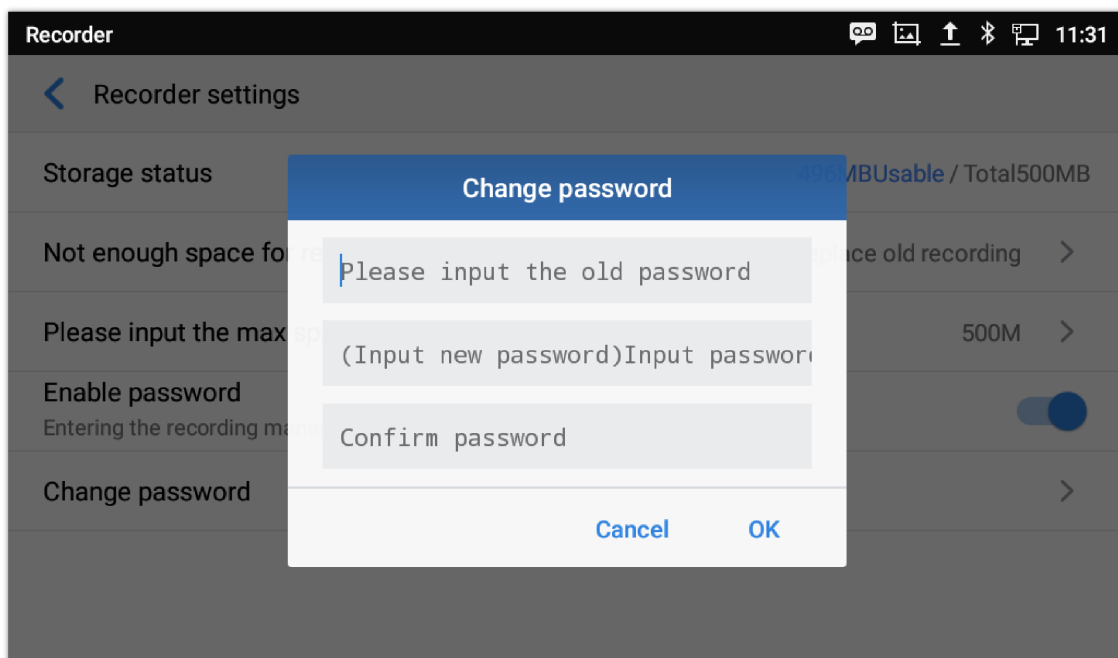

Figure 147: Change Password

## Files operations

Users could long press on each file to select it then perform the following operations on the select file.

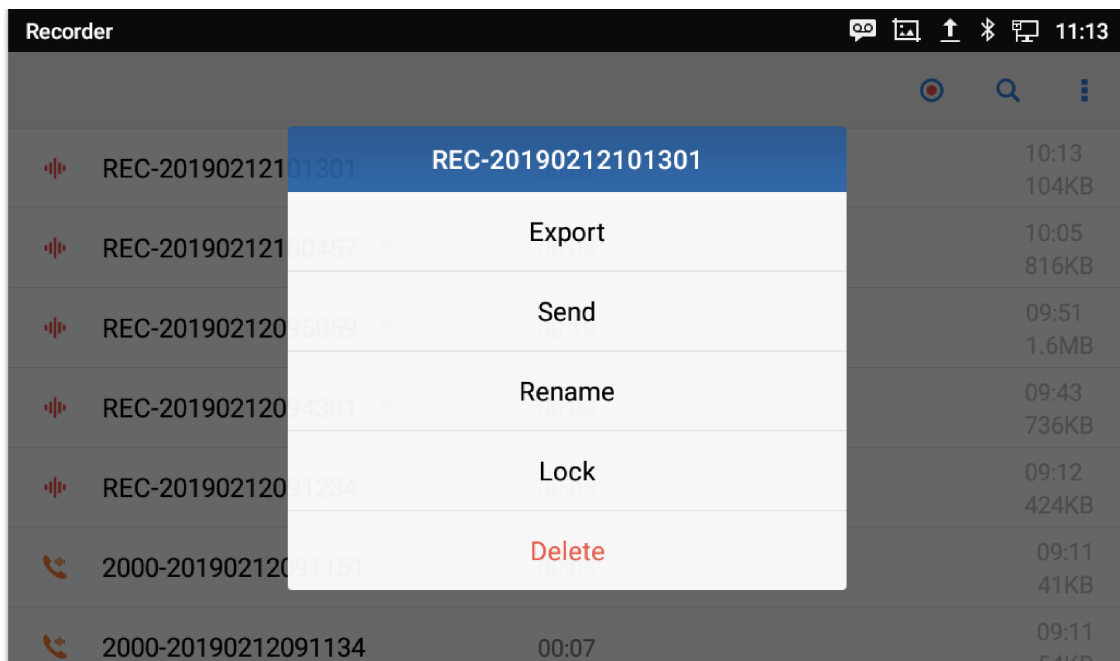

Figure 148: Files operation





**Export:** Choose this option to export the file to other storage destinations (SD card as example).

**Lock/Unlock:** Users could lock and unlock the file.

**Send:** Make sure to enable Bluetooth on the phone in order to send the file to other devices.

**Rename:** Click on this option in order to rename the file.

**Delete:** Choose this option to delete a file

Users can **Export** or **Delete** recordings alternatively by pressing on the Menu key , click on **Edit** and then select the file to operate on; choose  for file export,  to delete or  to send via Bluetooth and 3<sup>rd</sup> party APPs.

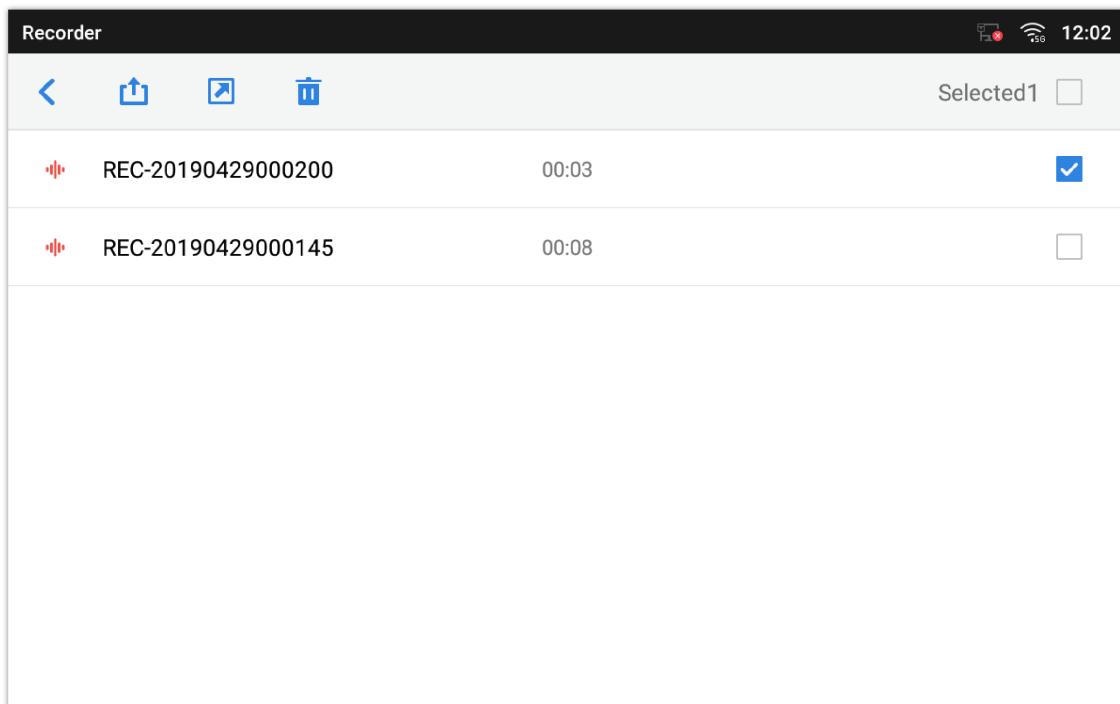



Figure 149: Export/Delete files

# FILE MANAGER

File Manager is a tool that allows users to delete, move, copy/past, send and rename files. It helps users to access and manage files in local storage as well as external storage devices (e.g, SD card/USB flash drive). Tap  on the phone's menu or desktop to launch File Manager application.

## Files Operations

### Copy and Paste Files

Follow the steps below to copy and paste a file on the GXV34x0:

1. Open file manager and navigate to the directory of the file to be copied. Touch and press on the file for about 2 seconds until the options window pops up then press Copy.
2. Select the location to which you want to paste the file and press on  .

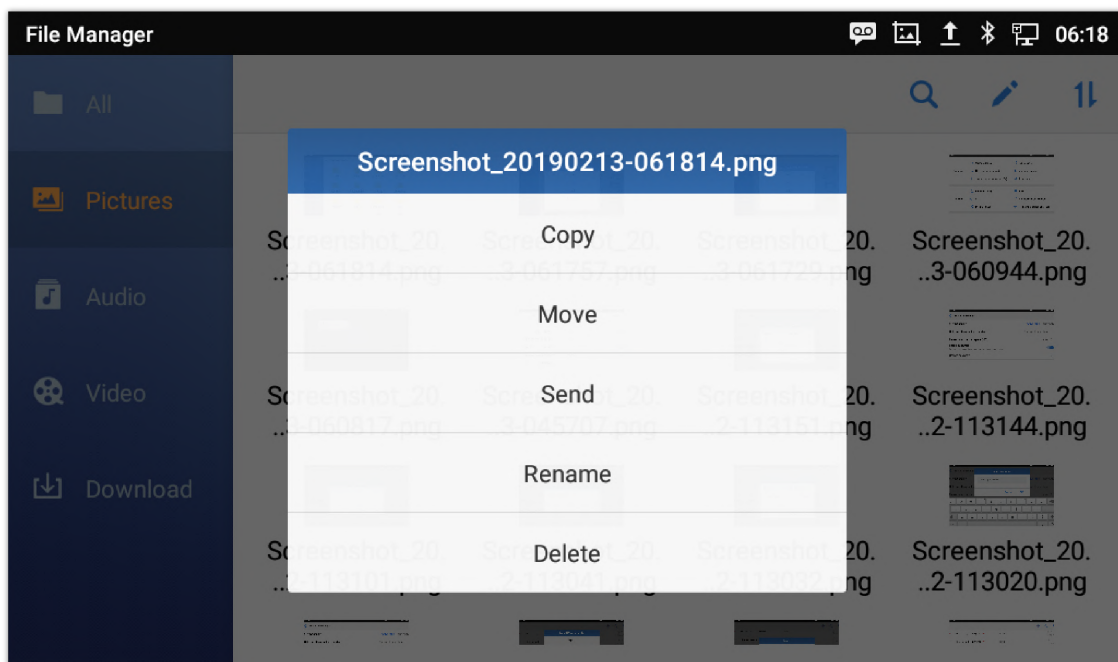





Figure 150: GXV34x0 File Manager – Copy File

Or

1. Press  on the top right corner of the screen and select the files to copy
2. Tap on  to copy the files selected
3. Select the directory to which you want to paste the files then press 

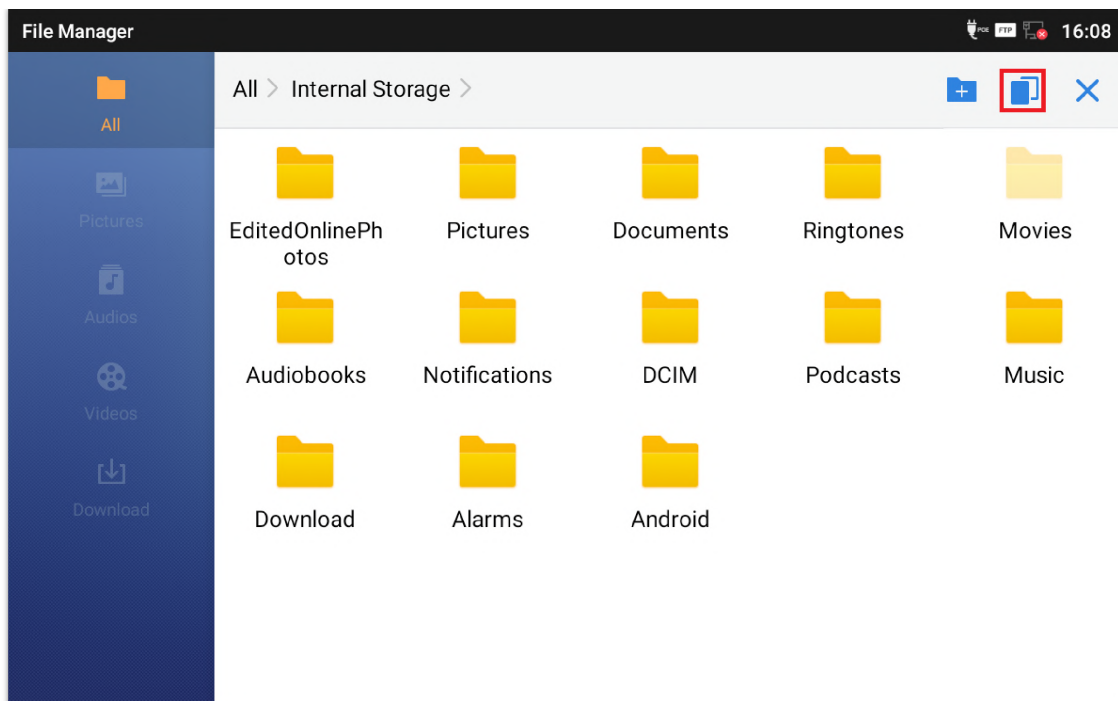



Figure 151: Paste File

## Move Files

The steps to move a file are similar to the steps to copy/paste a file. The difference is once the file is moved, the file will not be kept in the source folder. Follow the steps below to move a file on the GXV34x0.

1. Open file manager and navigate to the directory of the file to be moved. Touch and press on the file for about 2 seconds until the options window pops up then press Move.
2. Select the location to which you want to past the file and press on  .

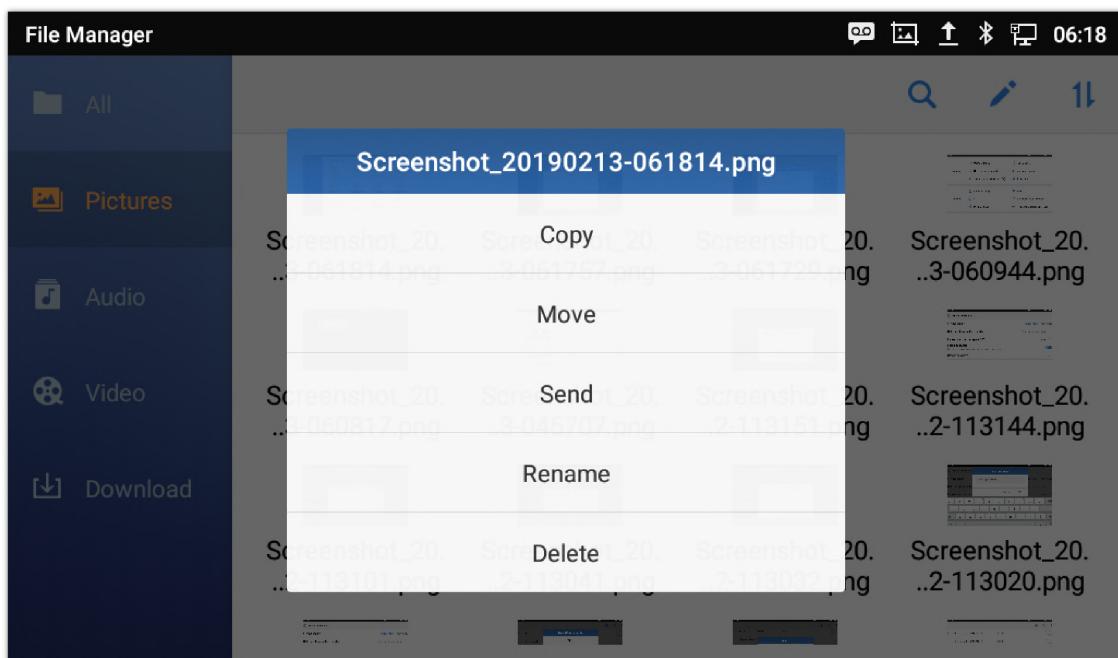

Figure 152: GXV34x0 File Manager – Move

## Send Files

The users can send a file via Bluetooth. Please make sure Bluetooth is turned on and connected to the Bluetooth devices. Otherwise, users will be directed to set it up before the file can be sent out.

To send a file:



1. Open file manager and navigate to the directory of the file to be sent over. Touch and press on the file for about 2 seconds and press send

2. Select the Bluetooth device to which the file will be transferred

Or

1. Open file manager and navigate to the directory of the file to be sent over then press on .

2. The check boxes will appear then check the files to be sent over

3. Press on  to send the selected files via Bluetooth then choose the Bluetooth devices to send the files to.

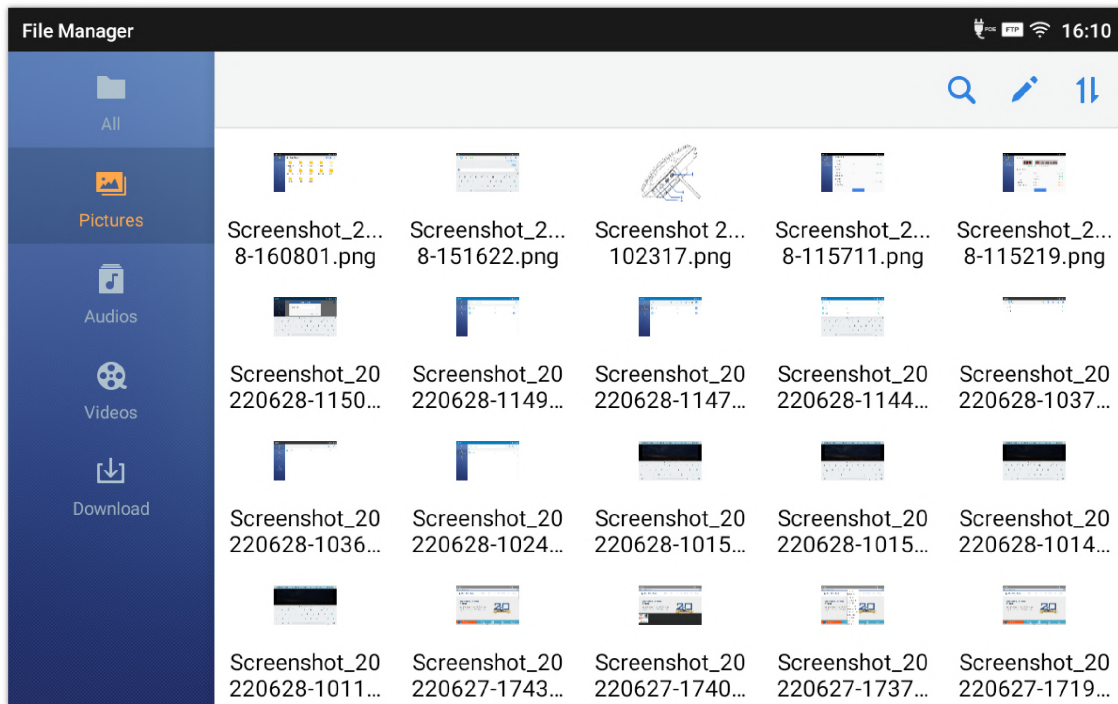

Figure 153: GXV34x0 File Manager – Options

## Delete Files

1. Open file manager and navigate to the directory of the file to be deleted. Touch and press on the file for about 2 seconds until more options appear.

2. Scroll down and select "Delete".

Or,

1. Open file manager and navigate to the directory of the file/files to be deleted the click on .

2. The check boxes will appear then check the files to delete

3. Press on  to delete the files selected.

4. Tap on **OK** to confirm.

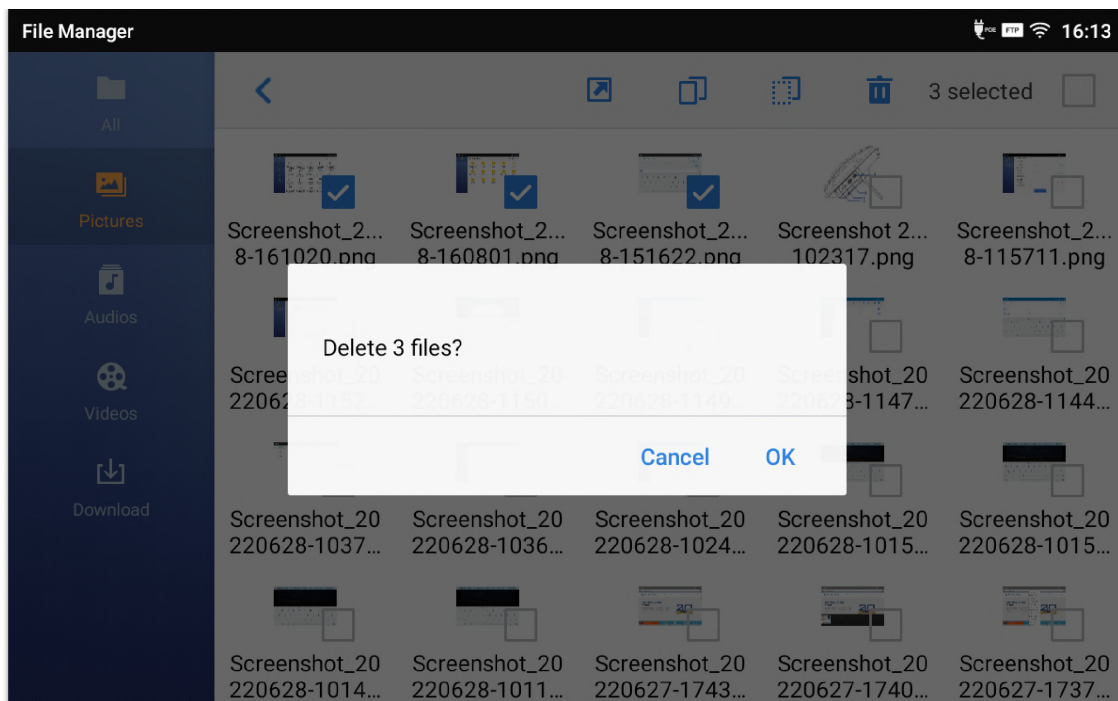

Figure 154: Delete File(s) via File Manager

## Rename a File

1. Open file manager and navigate to the directory of the file to be renamed. Touch and press on the file for about 2 seconds until more options appear.
2. Tap on "Rename". A new dialog window will pop up for users to enter the new name.
3. Tap on **OK**.

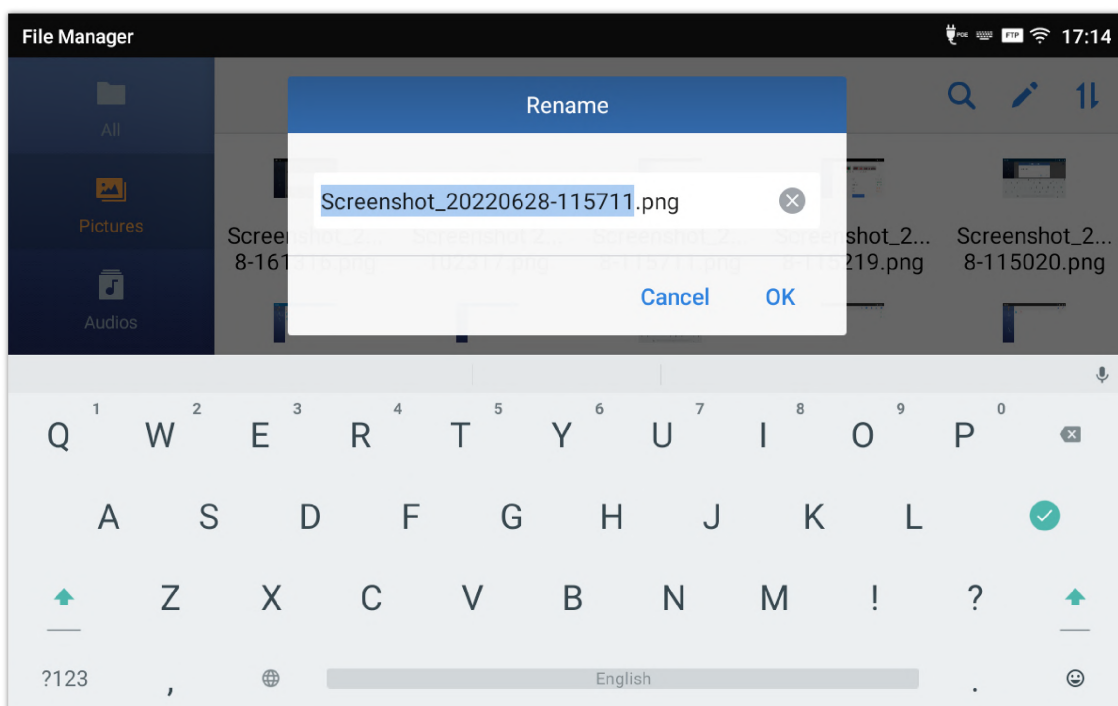

Figure 155: Rename File

## File Categories

The file manager will categorize the files stored on local/external storage based on the type of files. The available categories are

- **All**: gives access to all internal storage files as well as external storage devices.
- **Pictures**: contains all the pictures stored on the phone including screenshots, camera pictures and external pictures.

- **Audio:** contains all the Audio file on local and external storage.
- **Video:** contains all the videos stored on the phone including recorded videos from camera and videos stored on external devices.
- **Downloads:** in this category the phone will list all the downloaded files such as apps, document, music, videos ...etc.

## Focus Mode

The Focus Mode feature allows the users to access limited applications on the GXV34xx LCD panel, this is to reduce the distraction that can come with the standard mode such as notifications from installed software.

In Focus Mode, the home screen would only display basic functions such as: Dial, Contacts, SMS, Voicemail and general settings.

By Default , the GXV34XX is set to standard mode, to enable Focus mode:

- On the LCD screen, click the icon highlighted below:

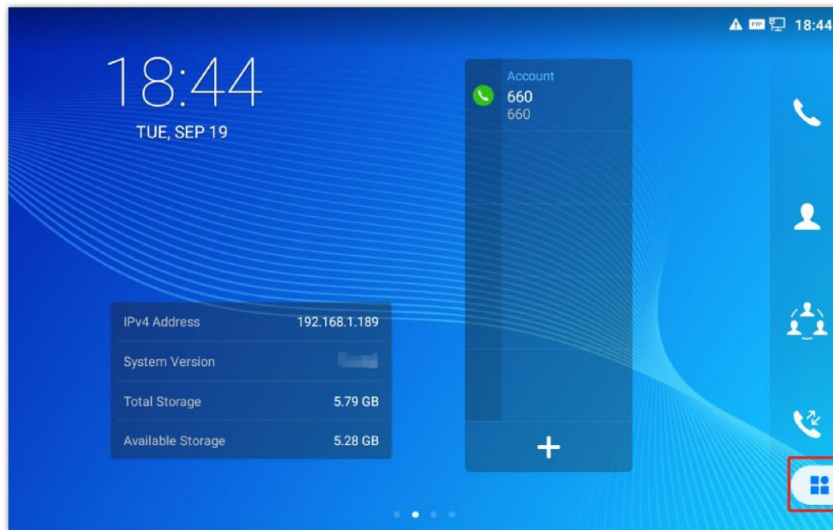

- You will be prompted with a confirmation pop up, to confirm, click on "Switch"

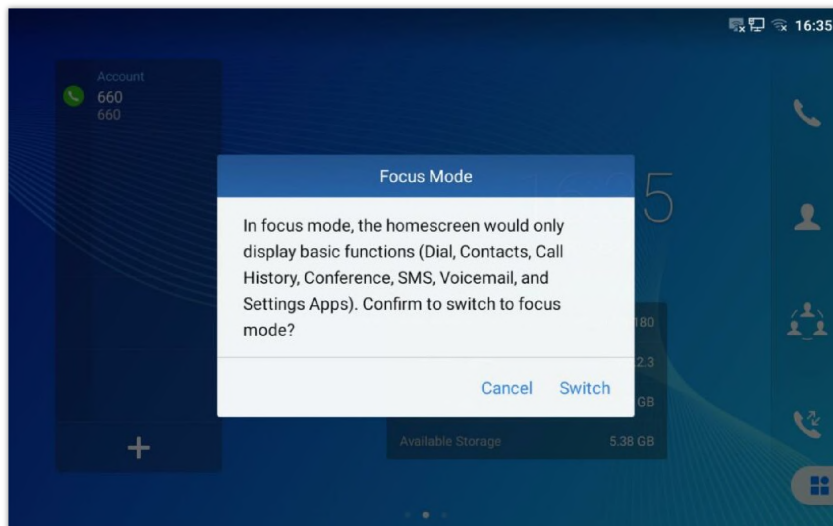

- Once confirmed you will access the GXV34xx Focus Mode.



- You can switch back to Standard Mode by clicking the highlighted icon below, and confirming to switch to Standard Mode:



## ZOOM MODE

Zoom Mode is added in GXV3450/GXV3480/GXV3470 to fully integrate the device with the Zoom app. Zoom Mode can be enabled from the web UI's top right corner, as shown below. The Zoom app will be launched automatically by the device. When enabled, the phone only runs the Zoom app.

### Note

Firmware release 1.0.1.27 for GXV3450 and GXV3470 includes updated Zoom modules, improving stability, performance, security, and introducing new features for enhanced Zoom functionality.

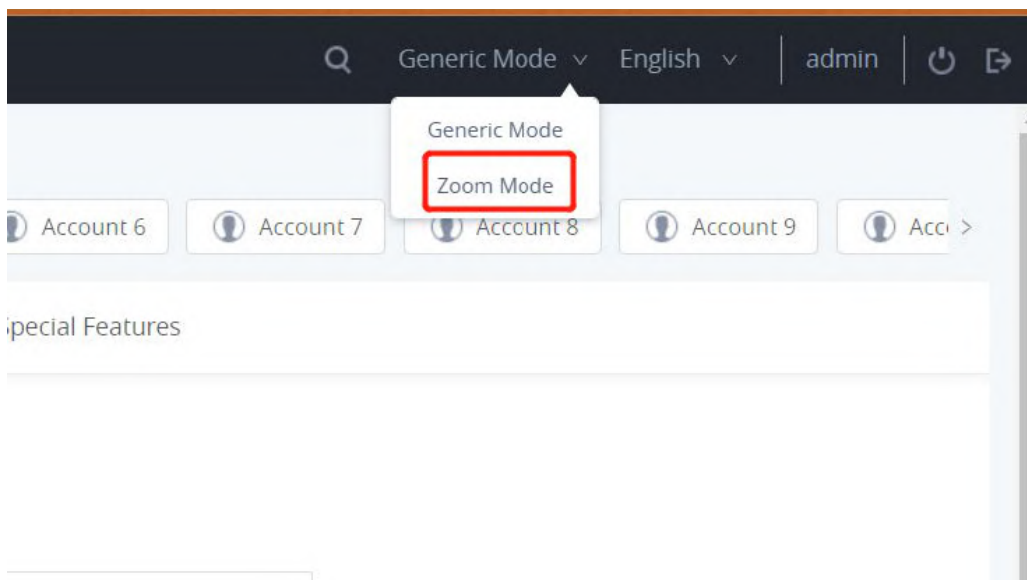

Switching to Zoom mode

## Join a Meeting

To be able to join a zoom meeting from the GXV34xx, please follow the below steps :

1. On the main page of the GXV34xx zoom mode, Click on "Join", this option will allow you to join a zoom meeting hosted by another party.

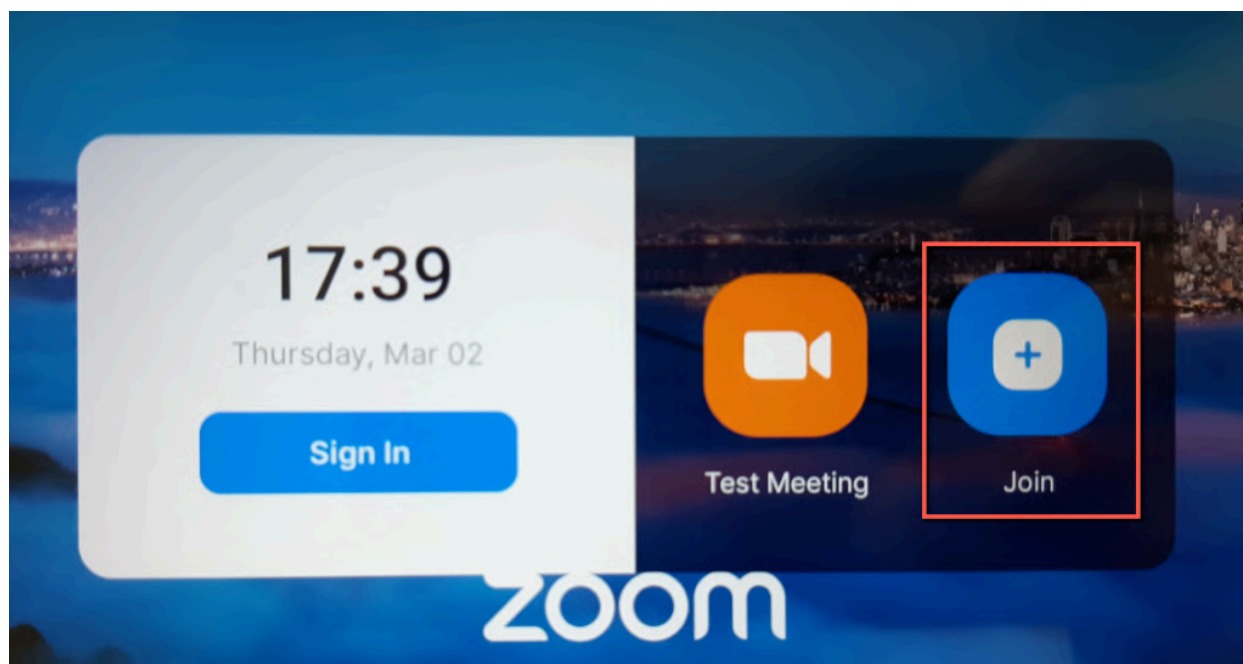

2. Once you click on the "Join" Icon , you will be prompted to enter the meeting ID generated by the Zoom application , that will be communicated by the Meeting's Host.



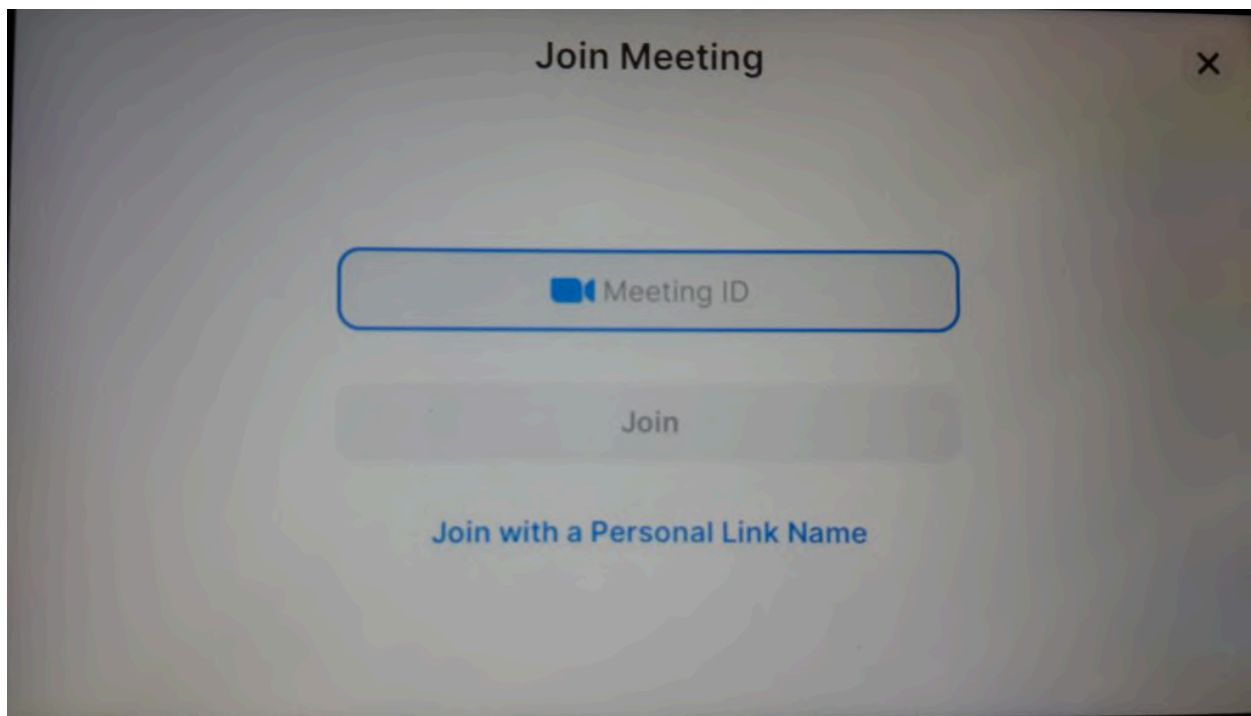

3. The next step will be to enter the meeting's passcode provided by the Host.

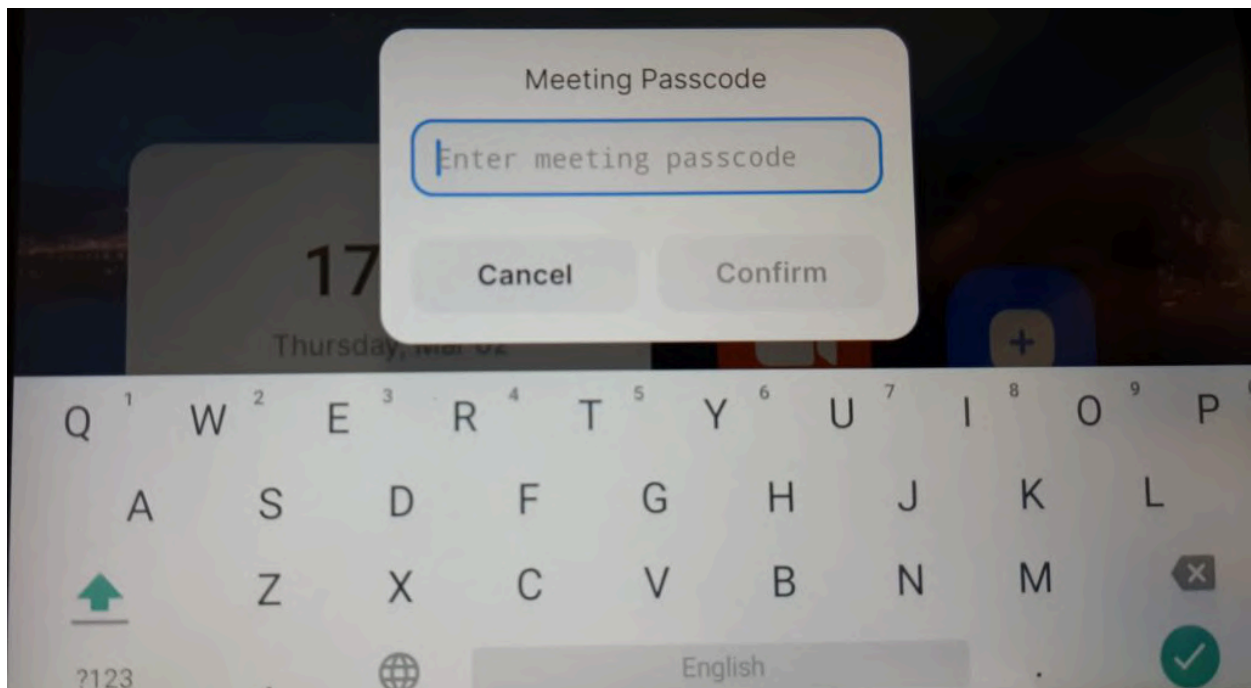

Once the credentials are entered correctly, you will be able to join the zoom meeting from the GXV34xx.

## GS MARKET

The GXV34x0 supports extensive amount of 3<sup>rd</sup> party Android applications. Users could install those applications from the built-in GS Market.

For example: Zoom App video communication platform which is an alternative option for video conferencing.

Tap on  at the phone onscreen menu to launch the GS Market. Users could browse, search, download and install the apps from there for tools, games and other applications.

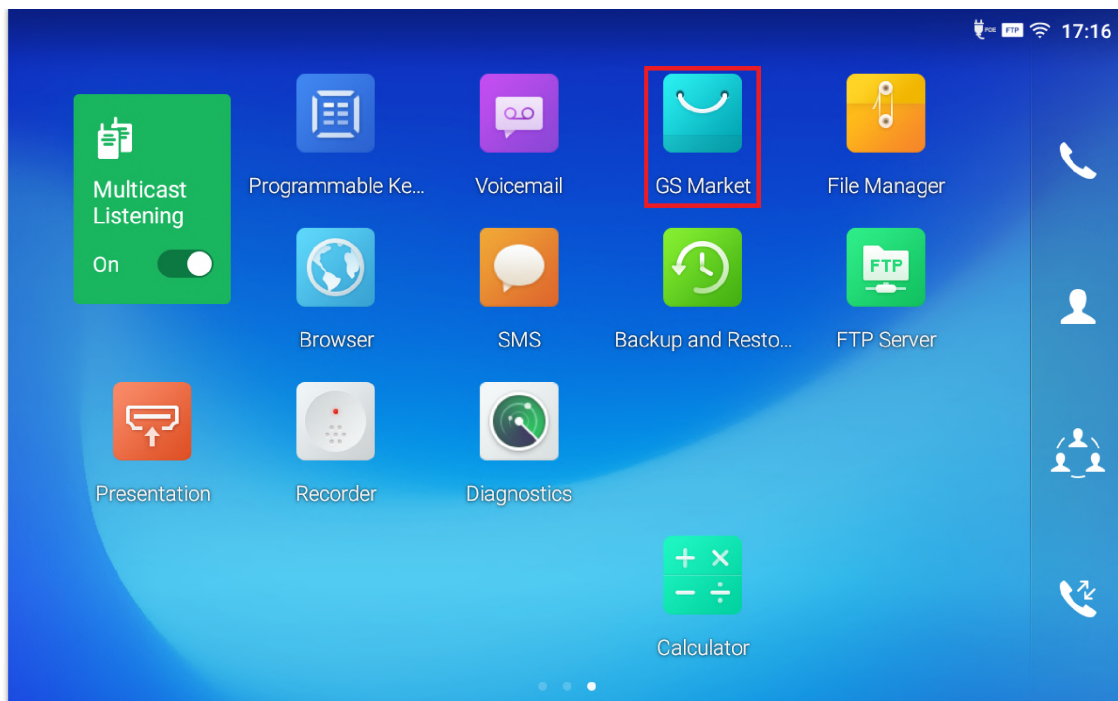



Figure 156: GS Market – Onscreen Menu

## FTP SERVER

The GXV34x0 supports file transfer via FTP server. Once installed, users could access the GXV34x0 file system from PC.

There are two ways for accessing FTP Server application:

- Users can either access the Built-in GXV34x0 application  in the **application screen**.
- Go to GXV34x0 **application screen** → **File Manager**, and click on the icon .

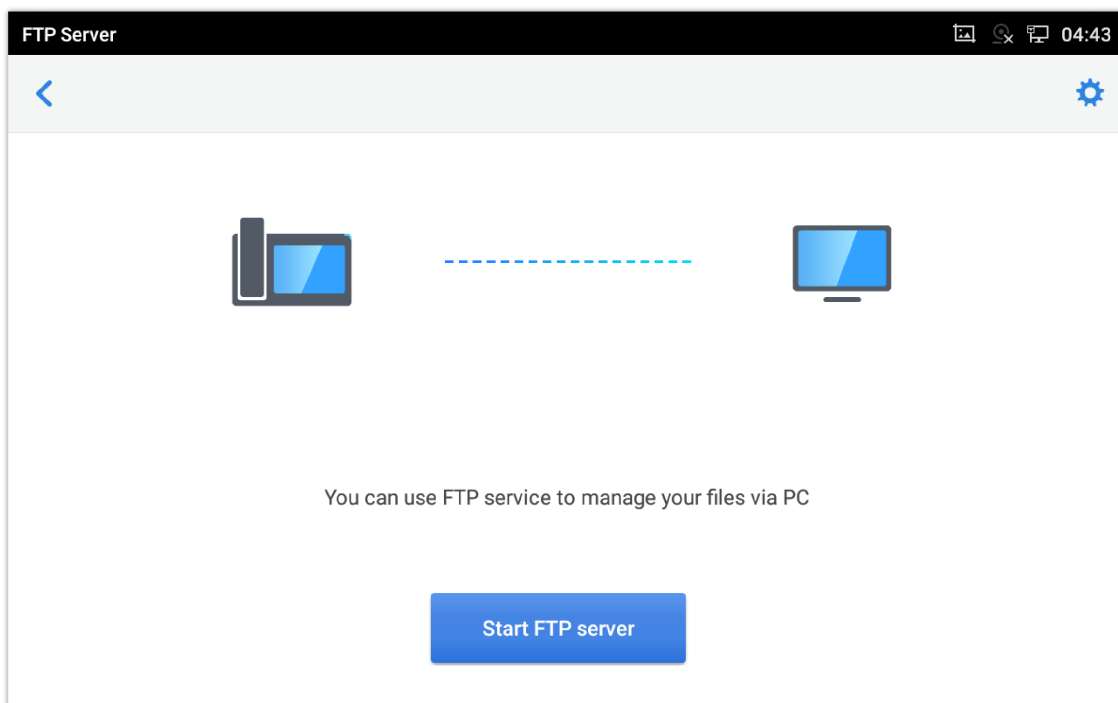

Figure 157: FTP Server – Start

Tap on “Start FTP Server” to turn the server on. The FTP server address URL will be provided on the screen.



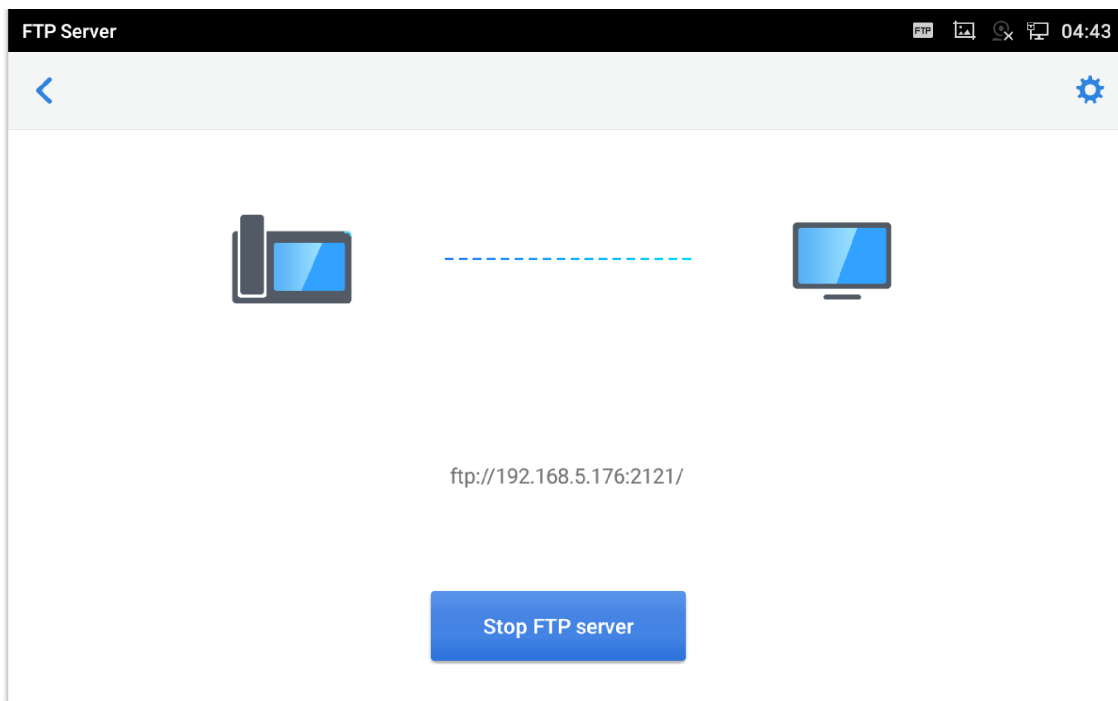



Figure 158: FTP Server – Stop

For security purpose, users could also tap on  in the above figure to set up username, password, port number and directory for remote access. By default, when the users access the ftp server from a PC, a prompt will show asking for user name and password. The default user name and password are "admin".

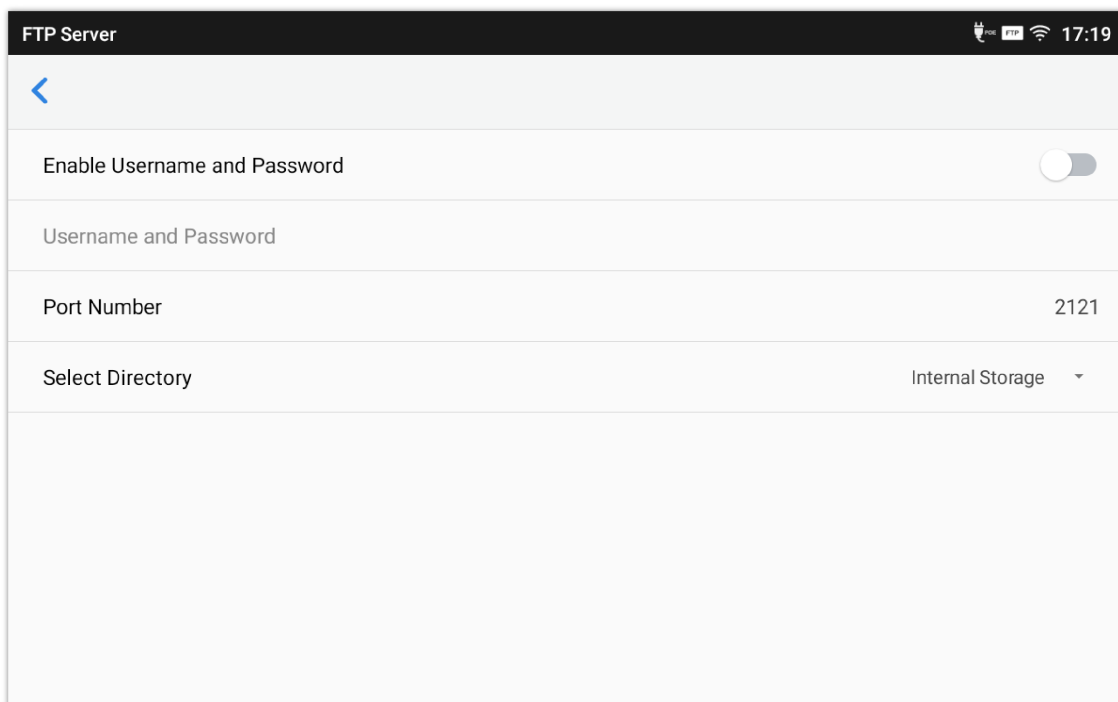

Figure 159: FTP Server – Settings

## Screensaver

User can set screensaver from the phone's idle screen under **Settings** → **Basic** → **Display** → **Screensaver**.

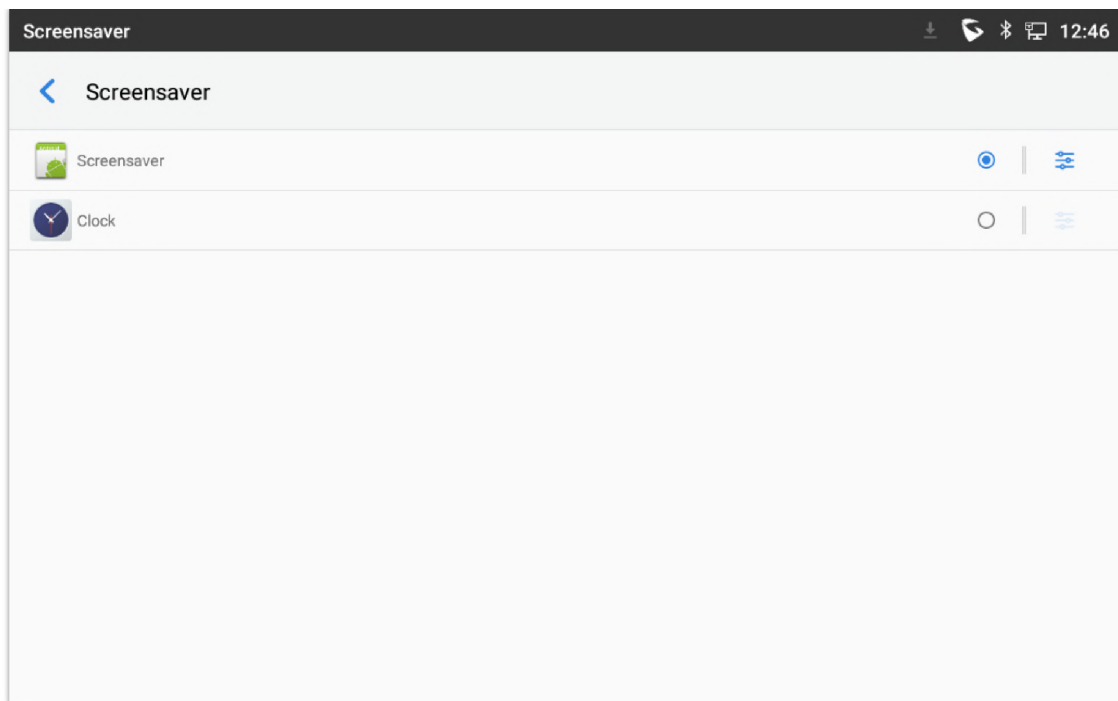



Figure 160: Screensaver settings

Users can set Screensaver to Clock or Screensaver.

- **Clock:** When setting the screen saver to Clock the phone will show a clock on the screen when the phone goes to standby mode. Press  to set the clock as Digital or Analog and Enable/Disable the Night mode.
- **Screensaver:** Users can set Screensaver from the local images, the default directory (Screensaver), or from Internal storage, or they can set a folder in a remote HTTP server to display images contained on it as screensaver. Press  to show the screensaver settings.

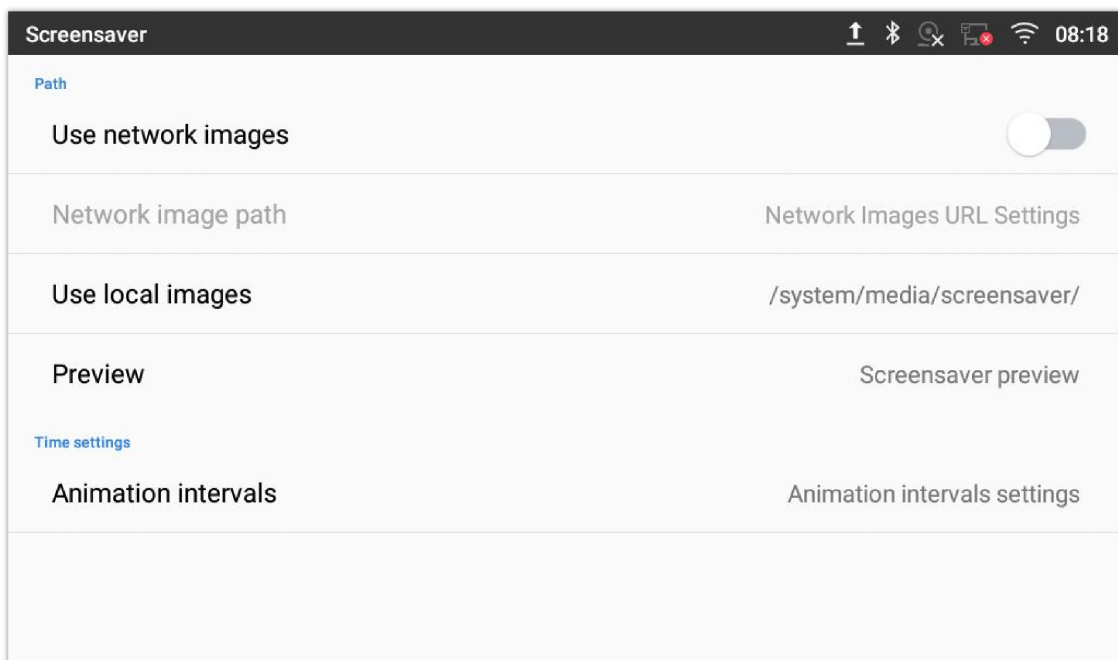

Figure 161: Use Network Images

Click on **Use network images** and set the path of the remote screensaver folder.

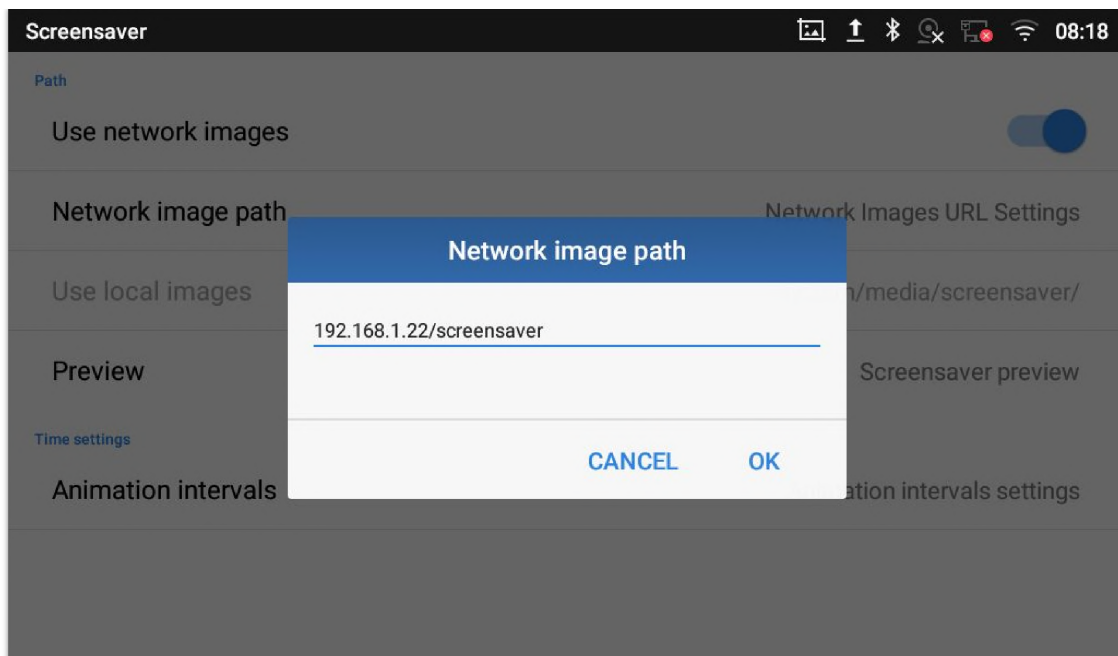



Figure 162: Network Image Path

## BROWSER

GXV34x0 browser could be used in a similar way as a PC-based web browser. Users can open web pages, bookmarks, view history, search ...etc. Tap  on the idle screen to launch the Browser application.

**Note:** The default page in the GXV34x0's Browser is Google Search.

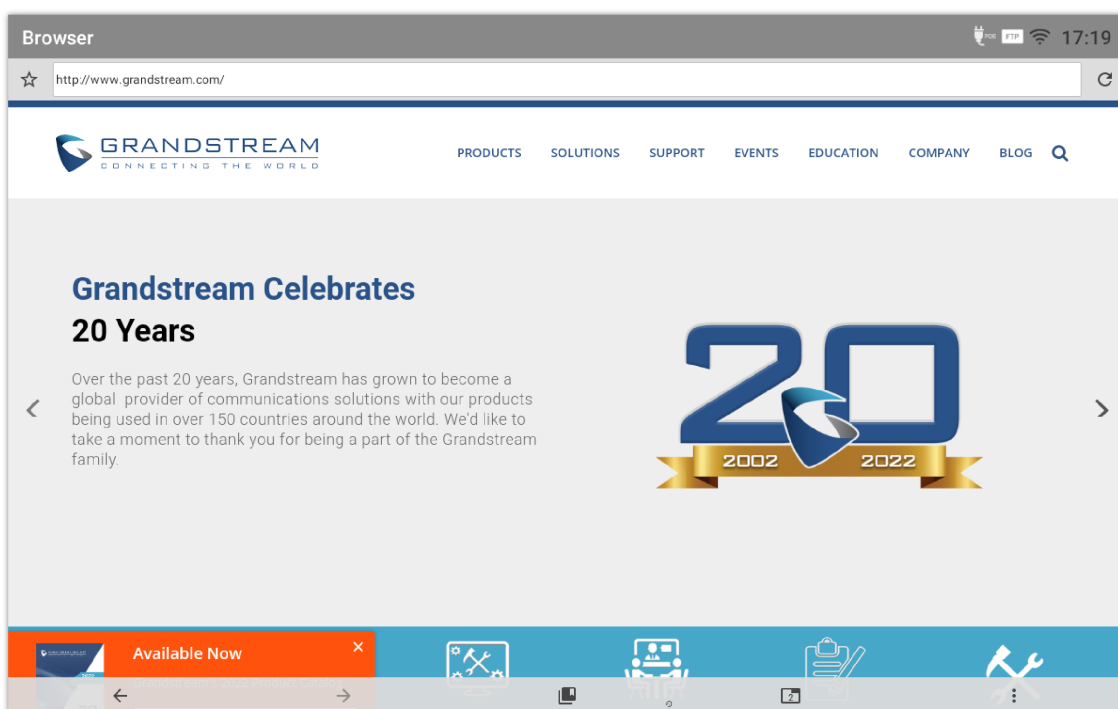



Figure 163: GXV34x0 Web Browser

- Touch the screen and scroll up/down/left/right to view the web page.
- Use two fingers on the screen to pinch in or spreading out the page.
- Press the MENU button  or press  to access more options including refresh New Tab, find on page, etc.

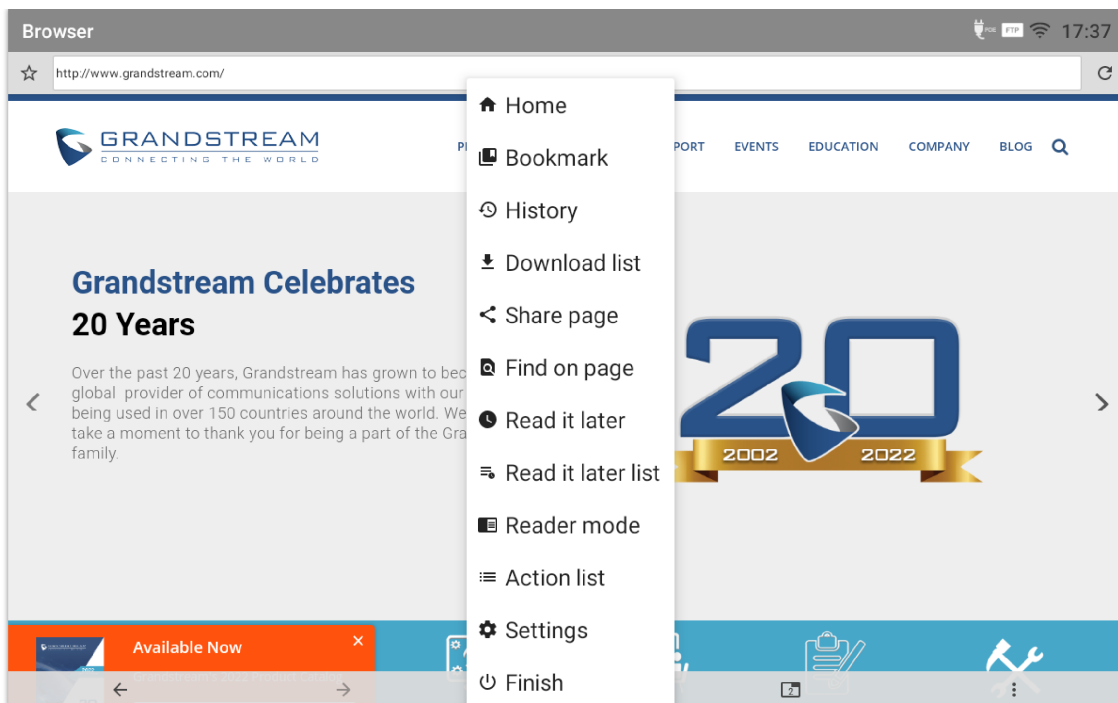

Figure 164: GXV34x0 Browser Menu Options

- o To open a new window, tap on  icon on the bottom of the page.

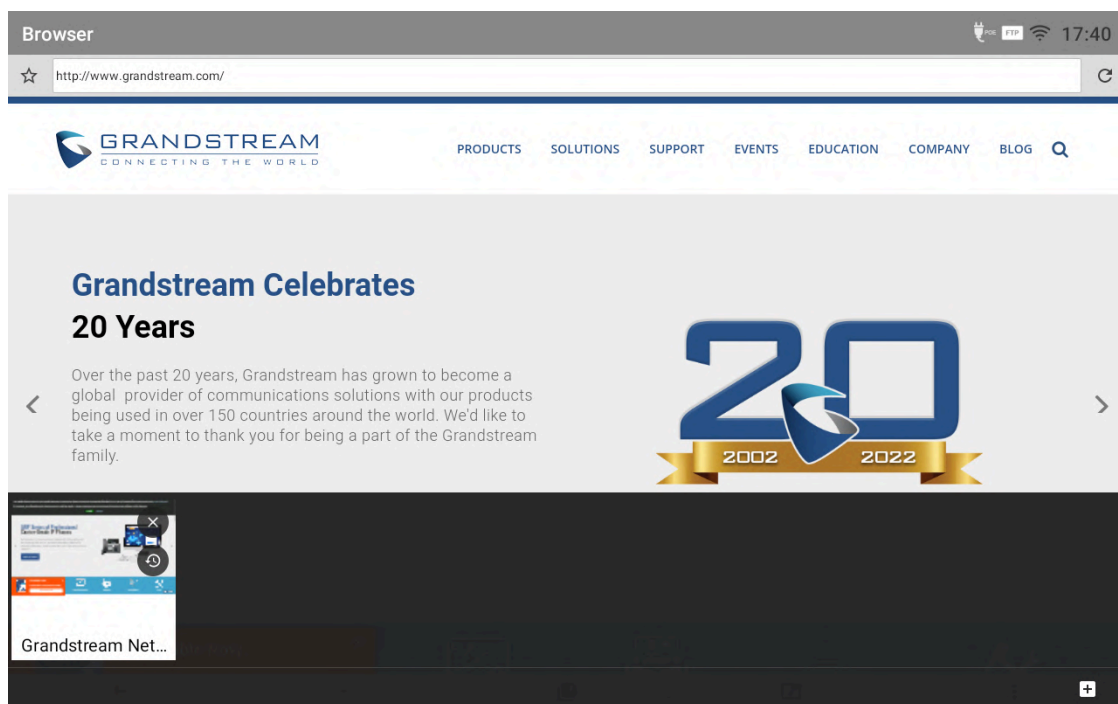



Figure 165: Open New Window in Browser

- o To open **Bookmarks**, **History** and **Saved Pages**, tap the icon  on the bottom of the Browser.

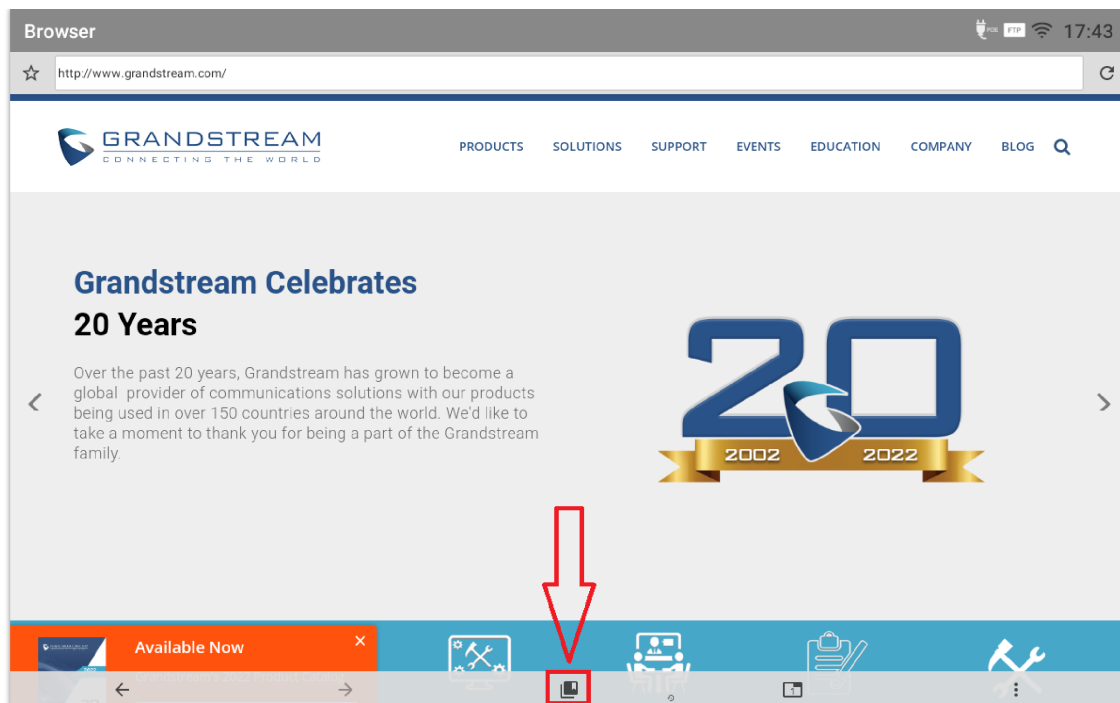
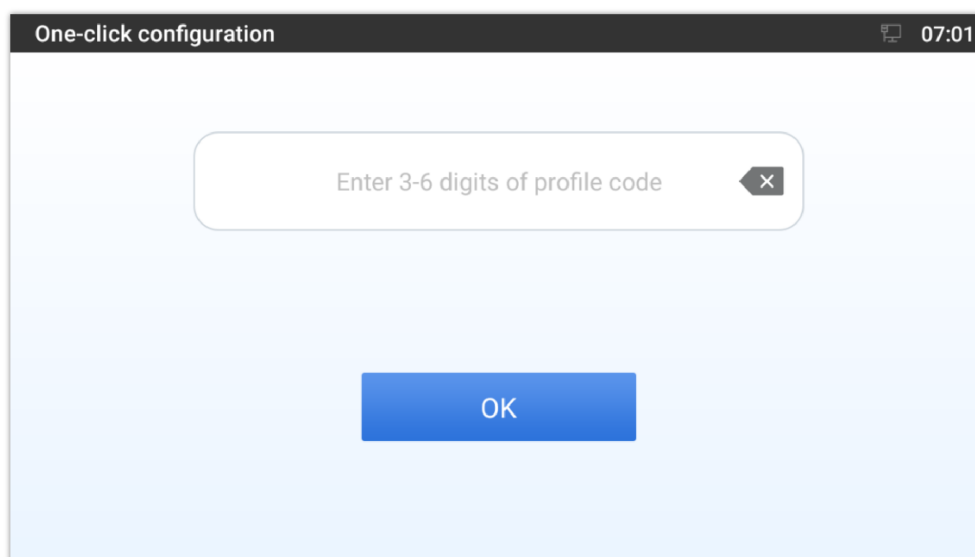

Figure 166: GXV34x0 Web Browser-Bookmarks

## ONE-CLICK CONFIGURATION

“One Click Configuration” is a specialized application designed to simplify the Process of SIP registration of the GXV Phones on the same network as the GCC601X.

Its primary function is to help provision an account from the PBX module of the GCC601x to a designated GXV device within the same network as the GCC.



One-Click Configuration

### How it works

- When your GXV34xx device boots up on the same network as GCC601X, the app is ready to help provision an account from the GCC device.
- Create the extension that you want to provision to the GXV device under the UC Endpoints module of the GCC601X, once created, an automatic 6-digits ID code will be generated for the specific extension, you can also manually provide a pin for the extension between 3-6 digits.

The screenshot shows the 'Add' form in the UC Endpoints interface. Under the 'Device Information' section, the 'Extension Number' is set to '1000'. Under the 'Identity Information' section, the 'ID Code' field is empty. Both the 'Extension Number' and 'ID Code' fields are highlighted with red boxes.

Manually provided ID code

The screenshot shows the 'Deployment List' table. It contains one entry for extension 1000, with a full name of 'John Doe' and an automatically generated ID code of '383553'. The ID code is highlighted with a red box.

Extension	Full Name	MAC Address	ID Code	ID Code Uses / Validity Period	Options
1000	John Doe		383553	3 times / Permanent	

Automatically generated ID Code

**Note**

The user have the possibility to import an excel file containing the extension numbers, then the ID codes will be automatically generated for each extension individually, the maximum number of extensions to be included in the excel file is 10 extensions.

- o Open the One-click configuration app, then simply input the unique ID code provided by GCC601X under the Fast Provision section of the UC Endpoints module of the GCC device.
- o The app verifies the entered profile code to ensure it's correct and authentic.

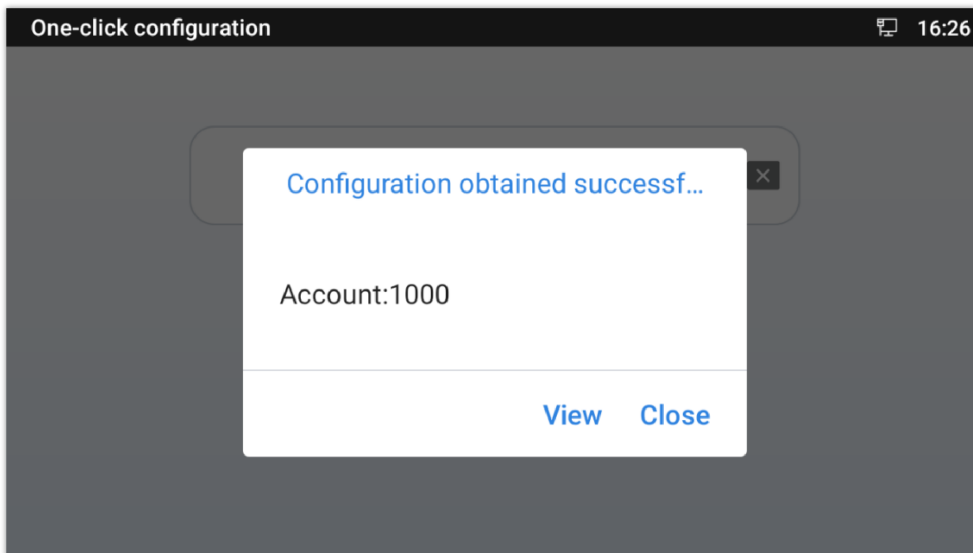

- o Once the code is validated, the GCC610x/W automatically provisions the assigned account to your GXV device.

The screenshot shows the 'Deployment List' table. It contains one entry for extension 1000, with a full name of 'Jonh Doe', a MAC address of 'c074adab0328', and an automatically generated ID code of '429014'.

Extension	Full Name	MAC Address	ID Code	ID Code Uses / Validity Period	Options
1000	Jonh Doe	c074adab0328	429014	3 time(s) / Permanent	

- o To prevent unauthorized access attempts, the app temporarily suspends provisioning for a brief period (typically 15 minutes) if the profile code is incorrectly entered multiple times.

“One-Click Configuration” simplifies the setup process for GXV34xx devices by automating the provisioning of assigned accounts based on a unique profile code, while also implementing security measures to safeguard against unauthorized access attempts.

## ACTION URL

GXV34x0 supports ActionURL module, and it is used to set the URL for various kinds of phone events on phone web GUI, and when the corresponding event occurs on the phone, phone will send the configured URL to SIP server. To use ActionURL module, users need to know the supported events in this module, and also added the dynamic variables of the supported events on phone web GUI. The dynamic variables of the supported event will be replaced by actual values of the phone, in order to notify the event to SIP server. Please refer to GXV34x0 Administration Guide and ActionURL User Guide for the configuration details.

[https://www.grandstream.com/sites/default/files/Resources/ActionURL\\_Guide.pdf](https://www.grandstream.com/sites/default/files/Resources/ActionURL_Guide.pdf)

## CONNECTING GXV34x0 TO DOOR SYSTEMS

The GXV34x0 offers a powerful integration with Door systems (GDS3710 Door System or others) and allows users to open the door, initiates call and gets real time audio/video stream.

In order to configure the GXV34x0 with the door system from the phone side, users need to go under GXV34x0 **Web GUI**→**Value-added Service**→**Value-added Service**. Please, refer to the GXV34x0 Administration Guide for more details about Value-added Service configuration.

Once the configuration is done, the call from the door system is answered on the GXV34x0 in full screen with the configured "open door" button to send the access password to the door system. Please, refer to the following figure:



Figure 167: Incoming call from GDS3710 door system

The GXV34x0 can be connected with the door system in two different ways, either using peering mode (without a SIP server) or through a SIP server. For more details, please refer to following guide describing the steps to connect the GXV34x0 to GDS37XX:

<https://documentation.grandstream.com/knowledge-base/connecting-gds37xx-with-gxv33xx/>

## CONNECT TO NETWORK AND DEVICES

The GXV34x0 supports a variety of network connections (Ethernet, Wi-Fi) and device connections, including EHS headset (Plantronics), USB and Bluetooth device. Users can connect the GXV34x0 and transfer files from/to the GXV34x0 using a USB connection or Bluetooth, the GXV34xx also supports HDMI out connection.



## Ethernet

Ethernet connection is turned on as DHCP by default. If you would like to use Ethernet connection for network access, please make sure the Ethernet cable is plugged in to the LAN port on the back of the GXV34x0.

To configure Ethernet settings on GXV34x0 LCD:

1. Go to GXV34x0's **Settings** → **Network** → **Ethernet Settings**.
2. Touch **IPv4 settings**.
3. Tap on "**IPv4 Address Type**" to select DHCP, Static IP or PPPoE as the address type.
  - For DHCP, save the setting and the GXV34x0 should be able to get IP address from the DHCP server in the network.
  - For static IP, enter IP Address, Subnet Mask, Default Gateway, DNS Server and Alternative DNS server for the GXV34x0 to correctly connect to network.
  - For PPPoE, enter PPPoE account ID and password so the GXV34x0 can get IP address from the PPPoE server.

## Wi-Fi

Wi-Fi is supported and built-in on the GXV34x0. GXV34x0 can be connected to network if Wi-Fi is available within the area.

### Turn On/Off Wi-Fi

1. Go to GXV34x0's **Settings**.
2. Touch **Network**.
3. Check or uncheck the option for **Wi-Fi**.

Or, users could open the top status bar and tap on Wi-Fi icon  to turn it on/off.

### Connect to Wi-Fi Networks

1. Once Wi-Fi is turned on, GXV34x0 will automatically start the scanning within the range.
2. Go to GXV34x0's **Settings**.
3. Touch **Network**.
4. Touch **Wi-Fi Settings**.
5. A list of Wi-Fi networks will be displayed as scanning result. Tap on the SSID and enter the correct password information to connect to the selected Wi-Fi network.
6. The phone will start connecting to the Wi-Fi. The status bar will show Wi-Fi signal strength.
7. Once it's added and the password is remembered, the GXV34x0 will connect to it again when the SSID is within the range.

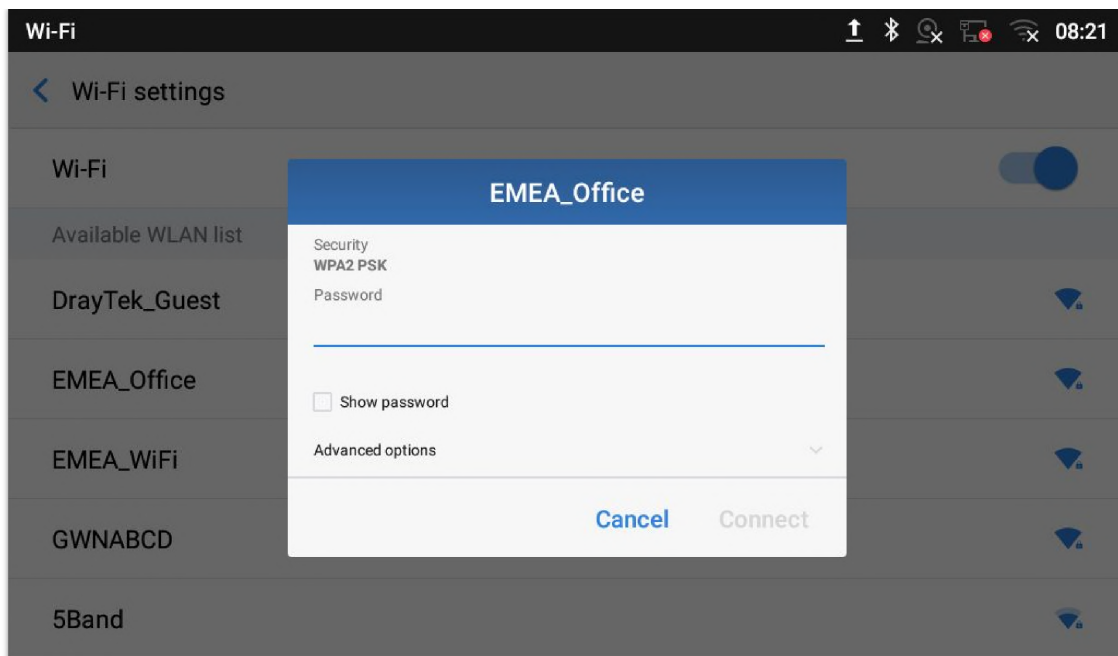

Figure 168: GXV34x0 Connect to Wi-Fi

- The previous steps allow the GXV34x0 to connect the Wi-Fi network with DHCP setting by default. If it needs to be connected the Wi-Fi with static IP settings, please scroll down the setting window and tap to check the **"Show advanced options"**. Then the window will show up the IP settings at the bottom. If the Static is selected, the system will require end user to input IP address, Gateway, Network prefix length and DNS 1 and DNS 2 addresses.

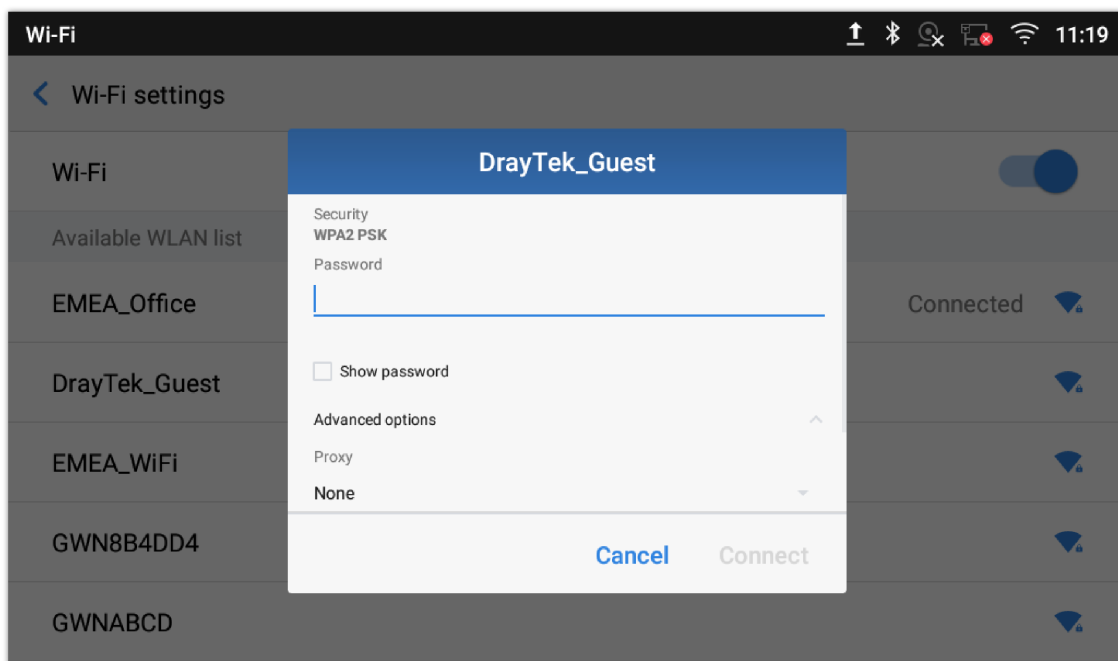

Figure 169: GXV34x0 Connect to Wi-Fi-Show Advanced Options

- If there is a need to modify the saved Wi-Fi network setting, the end user should tap and long press the SSID bar in the Wi-Fi setting page. The system will pop up a prompt and then users need to tap on **"Modify Network"**. Then, the phone system will pop up a new window to allow user to check the Wi-Fi parameters and change the setting by checking the **"Show advanced options"** at the bottom.
- User can also add Wi-Fi Networks manually if the network is hidden or not showing on the list of scanned SSIDs. User needs to roll down the Wi-Fi settings page and press on **"Add network"** and then enter the SSID name, Security type and Password.

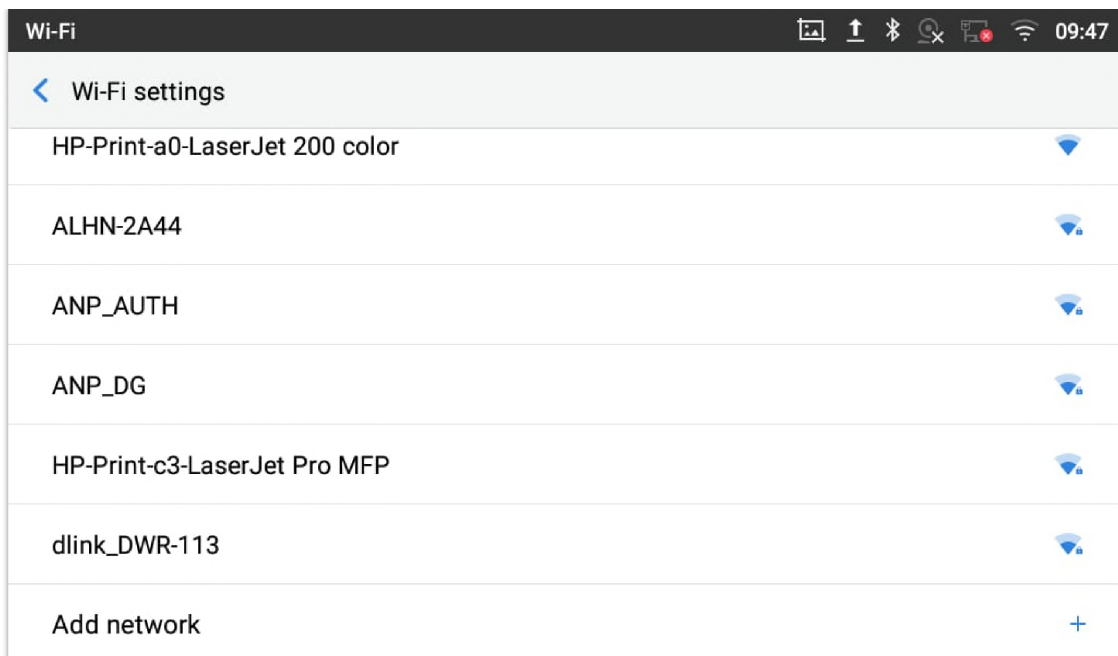

Figure 170: Wi-Fi – Add network

### Wi-Fi Settings Shortcut

Users can enter the Wi-Fi settings by sliding the Status Bar, then long Press on the Wi-Fi icon.

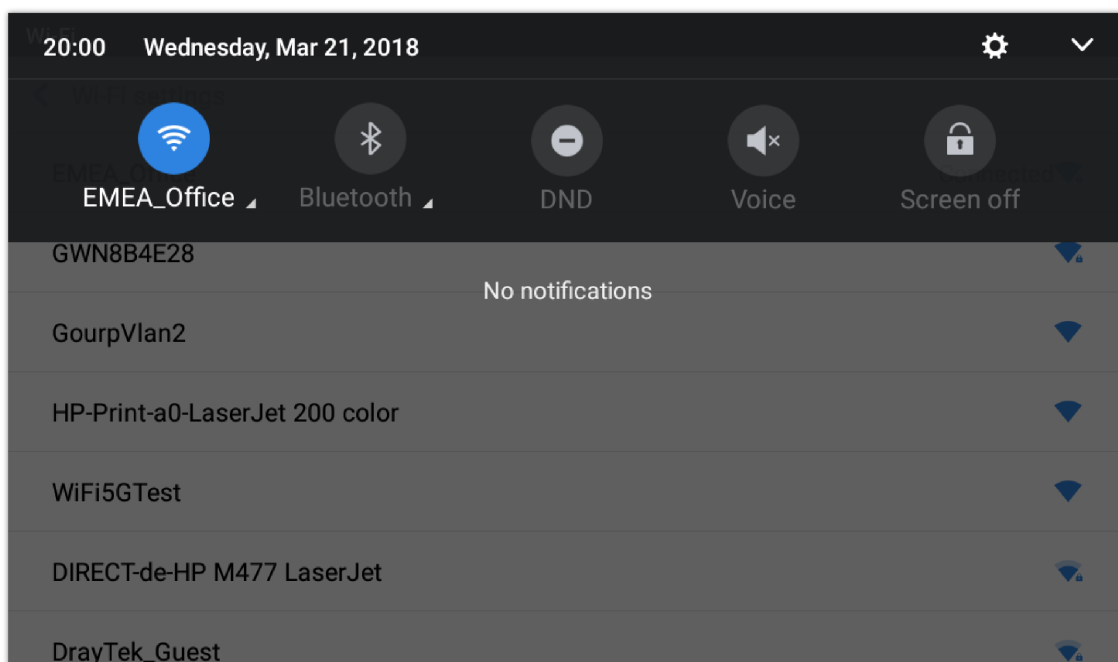

Figure 171: Wi-Fi Settings Shortcut

-Or-

Press the letter under Wi-Fi icon this will show the list of the Wi-Fi networks detected. Press “More Settings” to access the Wi-Fi settings.

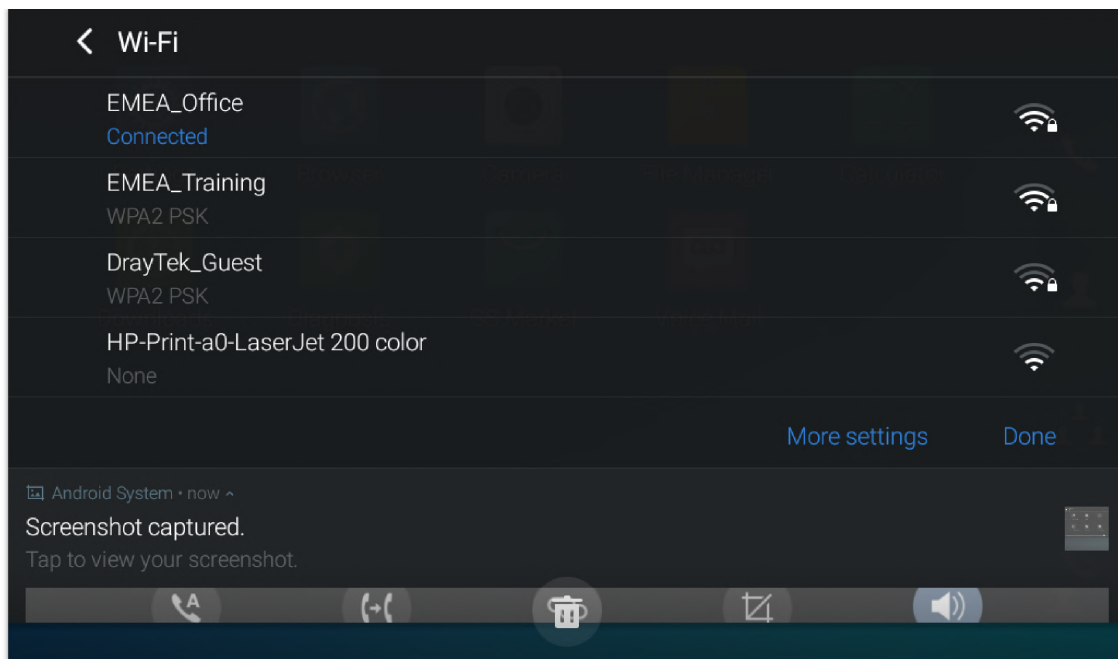

Figure 172: Wi-Fi Shortcut – Wi-Fi List

For more information about how to use Wi-Fi on the GXV34x0, please refer to this [guide](#).

## Bluetooth

Bluetooth is a proprietary, open wireless technology standard for exchanging data over short distances from fixed and mobile devices, creating personal area networks with high levels of security. The GXV34x0 supports Bluetooth, version 5. Users could use Bluetooth to transfer files, share contact information with other Bluetooth portable devices, use Bluetooth headset for making calls, switch calls to the GXV34x0 from mobile devices using Bluetooth hands-free profile, and listen to media (music or other audio output) from the GXV34x0

To connect to a Bluetooth device, turn on GXV34x0's Bluetooth radio first. The first time when using a new Bluetooth device with the GXV34x0, "pair" the device with GXV34x0 so that both devices know how to connect securely to each other. After that, users could simply connect to a paired device. Turn off Bluetooth if it's not used.

Bluetooth settings are under GXV34x0's **Settings**→**Features**→**Bluetooth**.

### Turn On/Off Bluetooth

1. Go to GXV34x0's **Settings** → **Features** → **Bluetooth**.
2. Check or uncheck Bluetooth option.

Or, users could open the top status bar→ tap on Bluetooth icon  to turn it on/off.

### Change Bluetooth Device Name

The GXV34x0 uses "GXV34x0XXXXXX" as Bluetooth device name by default where "XXXXXX" are the last 6 digits of the phone's MAC address plus 2, for e.g. If the phone's last 6 digits of MAC address is D33B4C, the Bluetooth's name would be GXV34x0\_D33B4E. The device name will be visible to other devices when connecting them. Follow the steps below to change the name:

1. Go to GXV34x0's **Settings**→**Features**→**Bluetooth**
2. Turn on **Bluetooth**.
3. Select **Additional settings**.
4. Press "Device name".
5. Enter a name and tap on "Rename".

## Pair GXV34x0 with a Bluetooth Device

Before connecting GXV34x0 with other Bluetooth device, users must pair them first. They will stay paired afterwards unless they are unpaired.

1. Go to GXV34x0's **Settings** → **Features** → **Bluetooth**
2. Turn on **Bluetooth**.
3. Tap **Additional settings** and select "Visible to nearby Bluetooth devices" to make the GXV34x0 phone visible to all nearby Bluetooth devices.
4. The GXV34x0 scans and displays the IDs of all available Bluetooth devices in range. If the device you would like to pair with does not show up in the list (available devices), ensure that the other device is turned on and set to be discoverable.
5. If the GXV34x0 stops scanning before the other device is ready, press  button to scan again.
6. Once the Bluetooth device shows up in the result, tap on it to start pairing. Confirm the passkey in the prompted message (if any). Or if passcode is required, please refer to the device's documentation or other procedures to obtain the passcode.

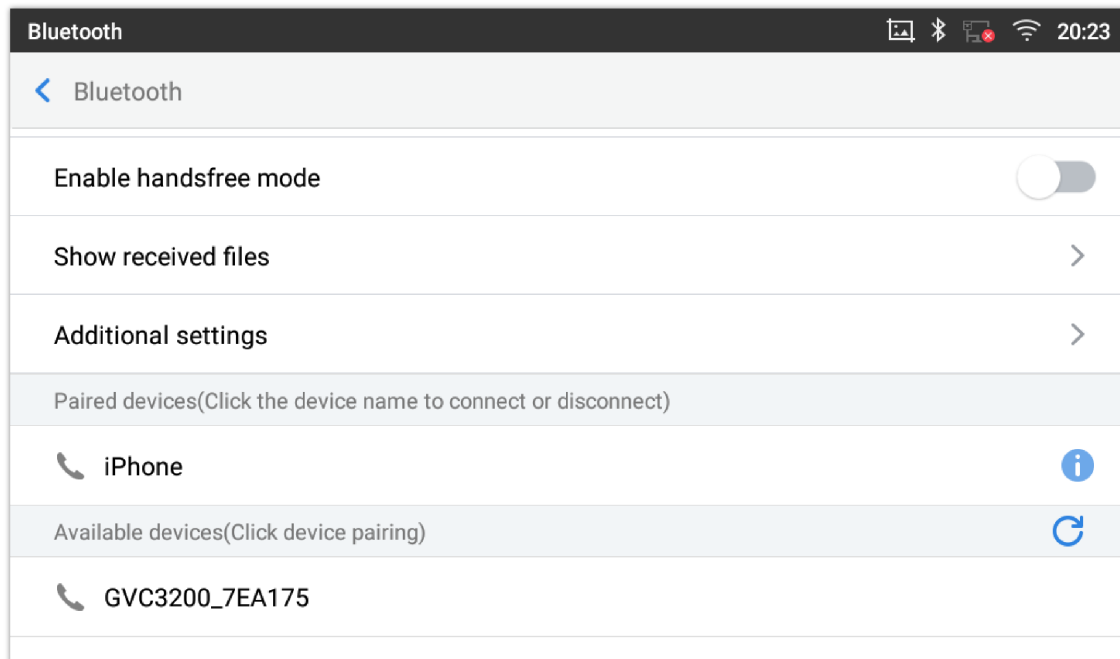



Figure 173: GXV34x0 Bluetooth – Paired Device

## Unpair a Bluetooth Device

1. In the Bluetooth settings, tap on  button corresponding to the Bluetooth device.
2. Select **Unpair**.

## Bluetooth Settings Shortcut

User can enter the Bluetooth settings by sliding the Status Bar, then long Press on the Bluetooth icon.

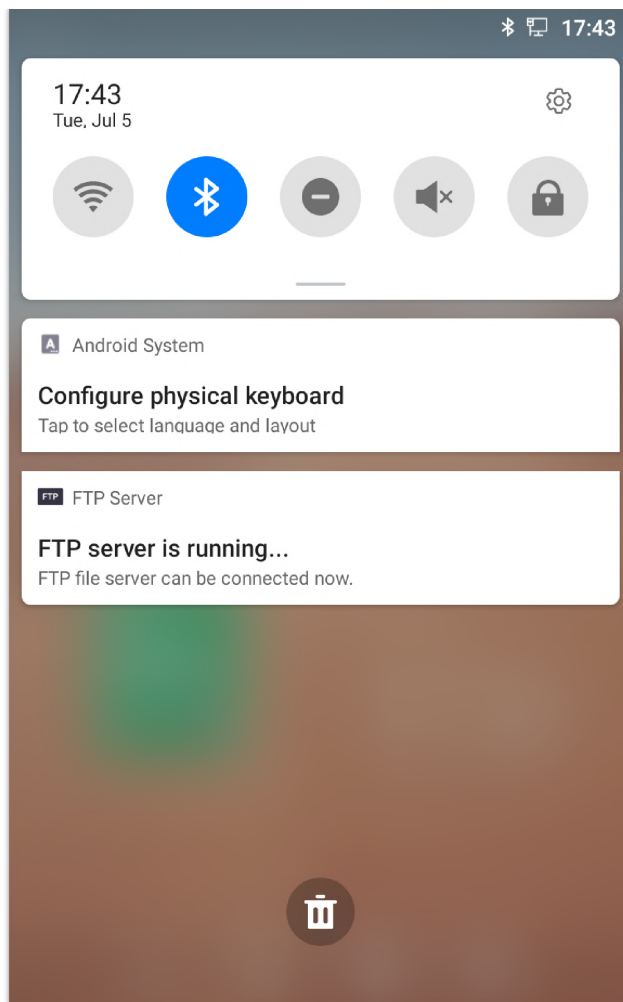

Figure 174: Bluetooth Settings Shortcut

-Or-

Press the letter under Bluetooth icon this will show the list of the paired devices. Press "More Settings" to access the Bluetooth settings.

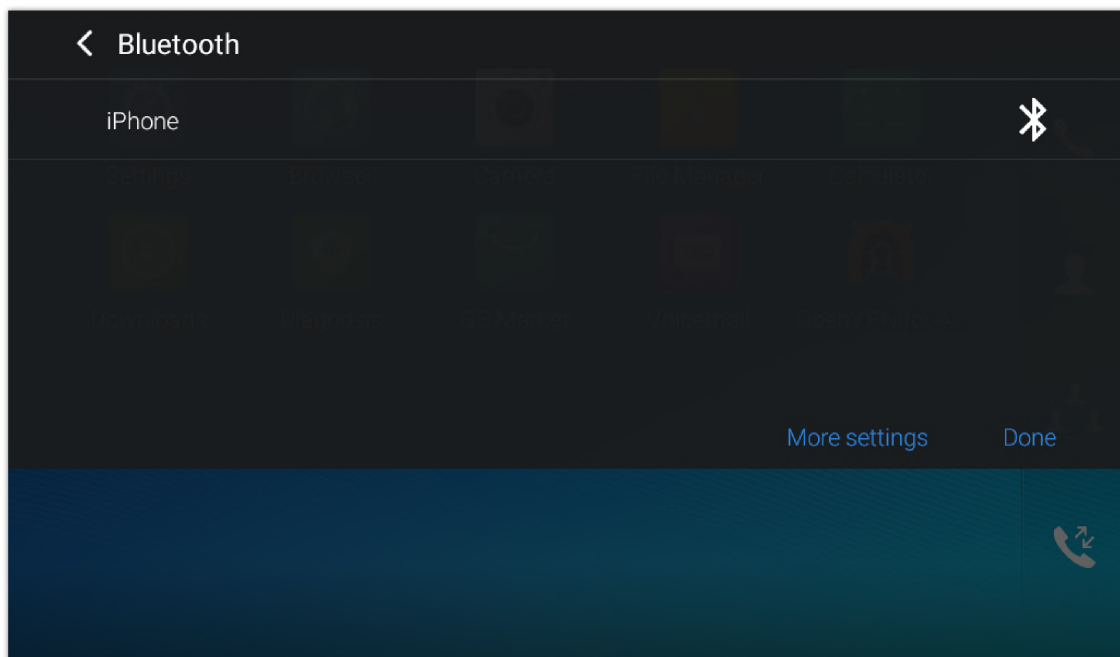

Figure 175: Bluetooth Setting shortcut 2

For more information about Bluetooth feature on the GXV34x0, please refer to the link below:

<https://documentation.grandstream.com/knowledge-base/gxv33xx-series-bluetooth-guide/>

## HDMI

The GXV34xx support to carry a connection for an external display device through an HDMI output port, this can be used to display the LCD content of the GXV34xx on an external monitor. the GXV34xx also supports the HDMI IN port that allows to display a presentation from a specific presentation source.

### Note

- HDMI Output feature is available only with the GXV3470 and GXV3480 models, that support a physical HDMI out port.
- HDMI Input feature is available only with the GXV3480, the only model that support HDMI in port.

## Echo Delay Adjustment

The echo delay adjustment feature allows the users to adjust echo delay when the device is connected to a media output via HDMI cable, the "echo delay" refers to the time it takes for an audio signal to travel from the sender (the person speaking) to the receiver (the person listening) and back.

This feature allows users to manually modify the timing of the audio signals, specifically when the IP video phone is connected to an external display via an HDMI cable. By adjusting the echo delay, users can potentially reduce or eliminate the echo effect, providing a clearer and more comfortable audio experience during calls.

you can find this setting under LCD -> Settings app -> Sound, it will be enabled after HDMI output device is connected.

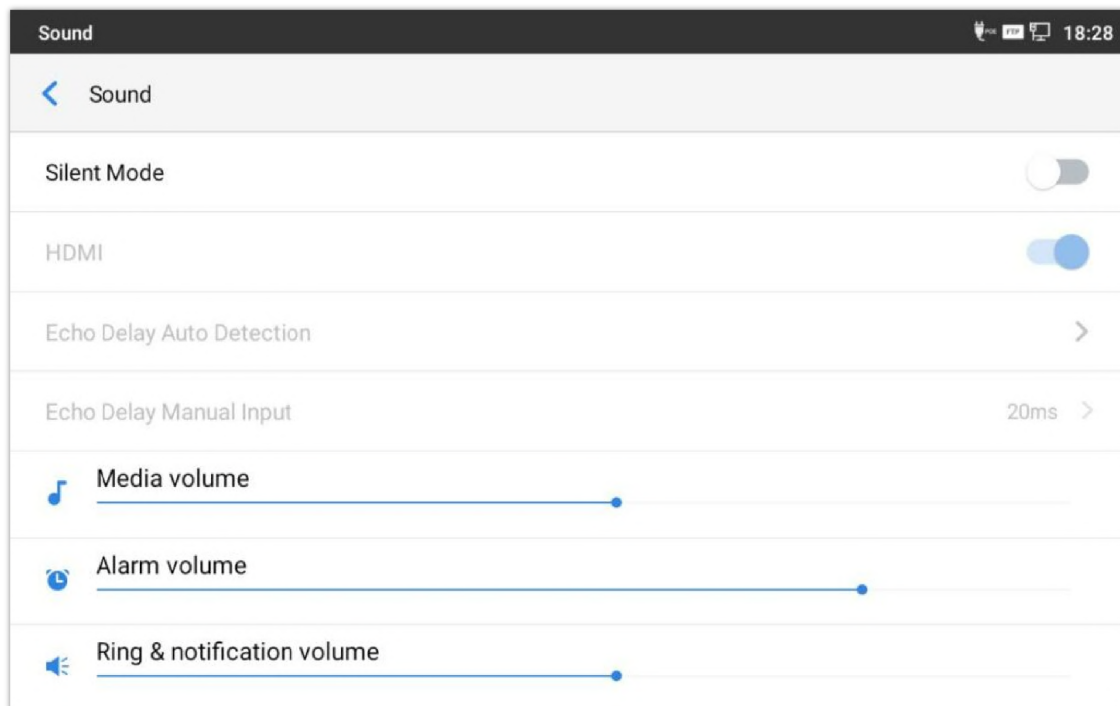

## EHS Headset

The GXV34x0 supports normal RJ9 headset and EHS headset. To use Plantronics EHS headset:

1. Go to the GXV34x0 Home screen → **Settings** → **Basics** → **Peripherals**: enable option "Plug RJ9/EHS headset"
2. Connect EHS Headset to the GXV34x0. Insert headset connector into the RJ9 headset port on the back of GXV34x0.



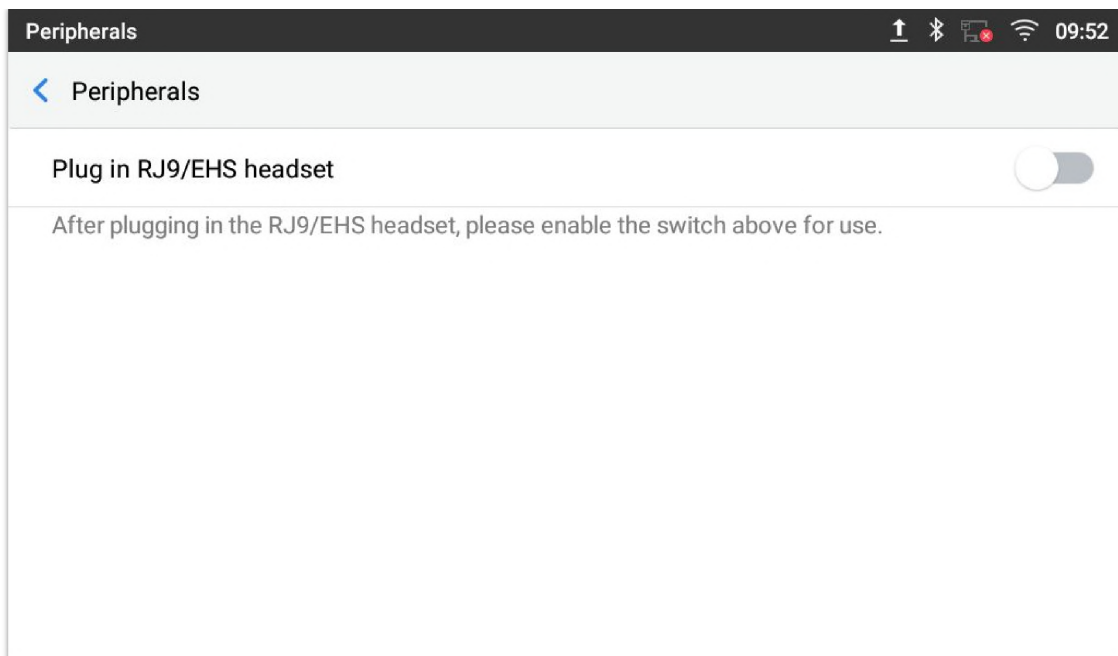
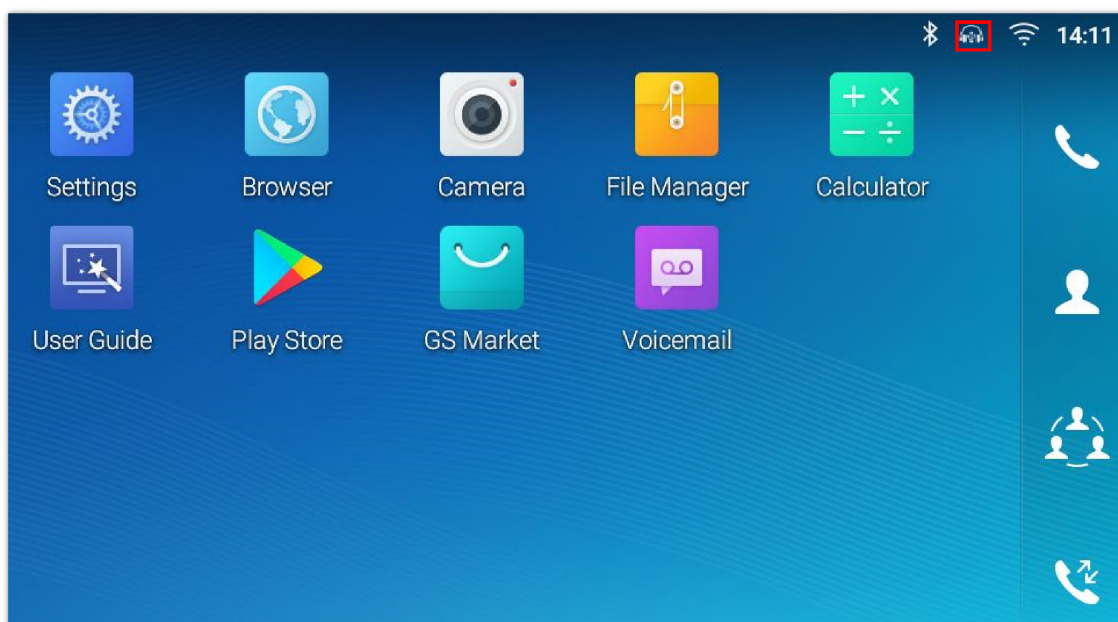

Figure 176: EHS headset

## USB Headset

The GXV34x0 supports the GU3005/3000 headset. The GU3000 and GU3005 are HD USB Headsets that offer high-quality sound. Ideal for remote workers and busy environments, these USB headsets feature a noise cancellation microphone that minimizes background noise to provide crisp HD audio. The headset features multiple call control features such as answer/end a call, volume adjustment and mute/unmute. Users can plug in the USB port with the headset and simply use the headset as default media input/output channel. For more details, please visit: <https://grandstream.com/products/personal-collaboration-devices/headsets>

Once the headset plugged, it will be detected automatically, and the following icon will be shown on the top right of the status bar, this means a USB headset is connected.



USB Headset Connected

In the calling page, user can press on the USB headset button (shown in figure below) to enable USB headset. The status bar shows the icon modified indicating that the USB headset is being used for speaking.

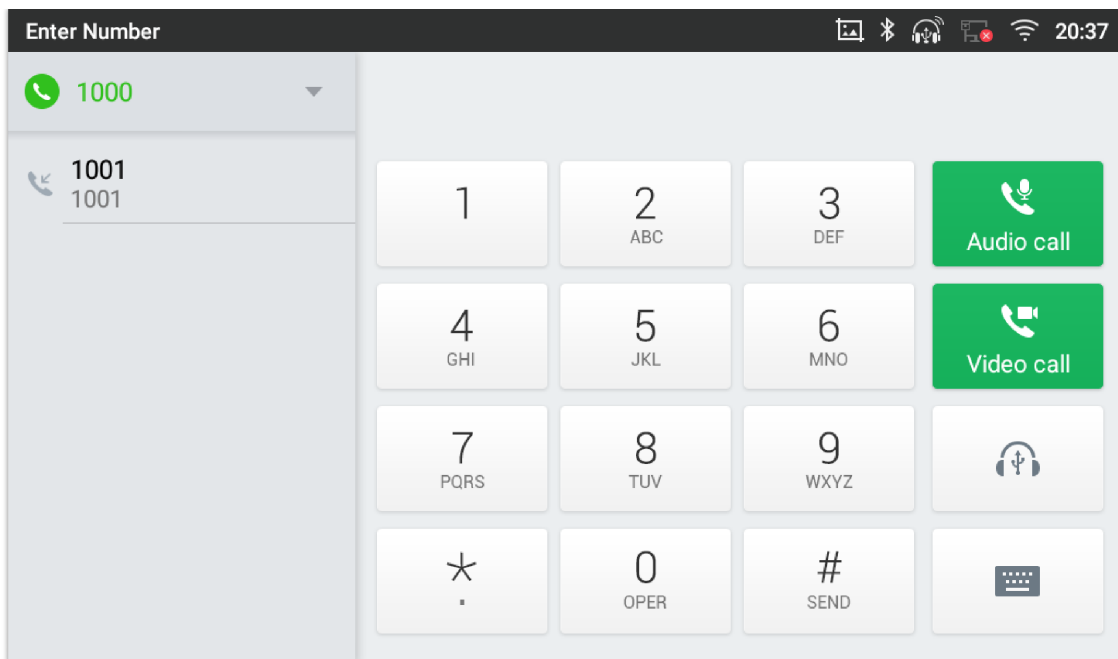

*USB Headset Used for Call*

During the call, users can tap on "More" then "Media Channel" to toggle between Handset Speaker and USB Headset.

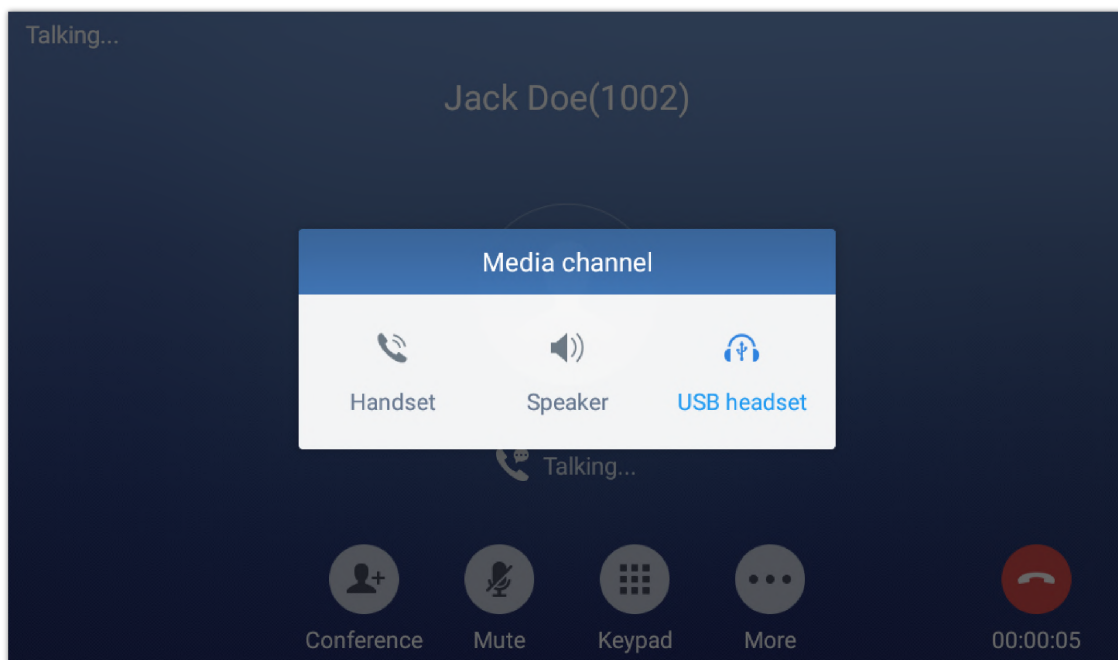

*Switch Between Speaker and USB mode*

## USB

The GXV34x0 supports USB connection with USB storage devices. To connect and access USB storage device:

1. Insert a USB storage device into USB port at the back or the side of the GXV34x0.
2. It will take a few seconds for the GXV34x0 to prepare the connection. Then the USB storage icon  will show on the status bar.
3. To access USB storage, go to GXV34x0 MENU → **File Manager** → **USB**. Tap on it to access and manage your data.

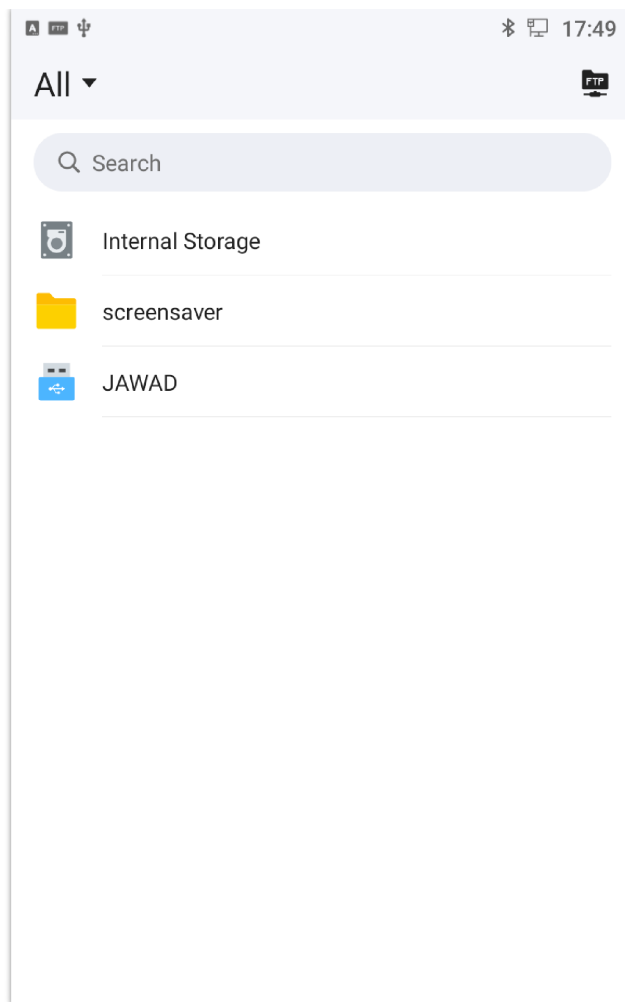

GXV 3470 USB Storage Device

## Dynamic Lock

Dynamic lock is a powerful security feature in the GXV34xx video phone series, it allows the phone to be automatically locked with the security locking method configured, once the paired device such as a cellphone is out of the Bluetooth range.

Dynamic Lock feature works as follows:

- Assuming you have a lock screen configured as a pattern, Go on LCD settings => Features => Dynamic lock.

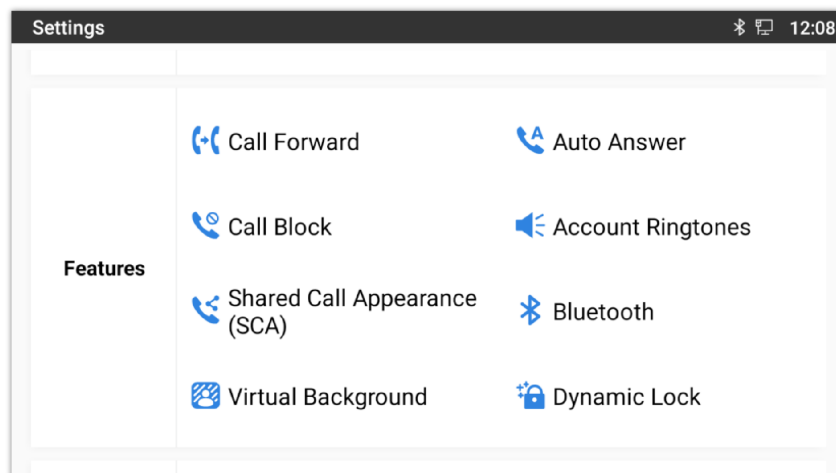

- Enable dynamic lock by enabling the option "Allow the phone to automatically lock when you are away"

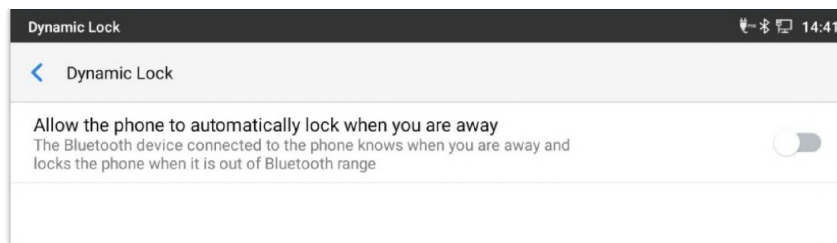

- Once enabled, make sure to pair your cellphone with the GXV34xx through Bluetooth.

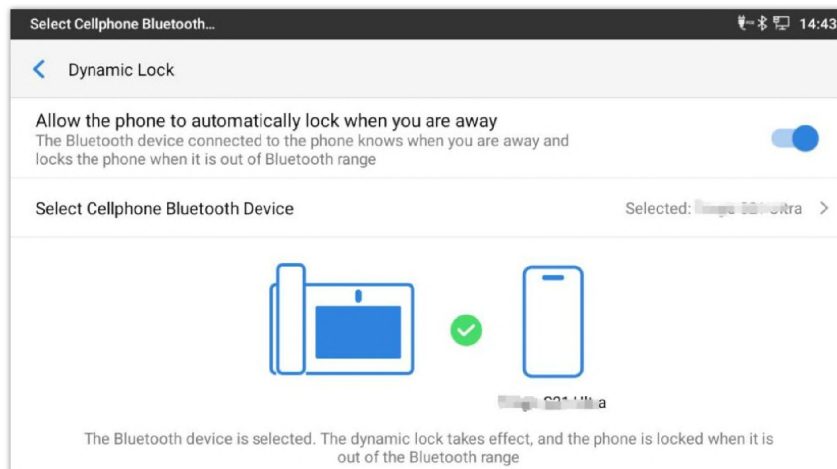

- Once the devices are paired, the GXV34xx will be automatically locked if it loses Bluetooth connection to the paired cellphone.

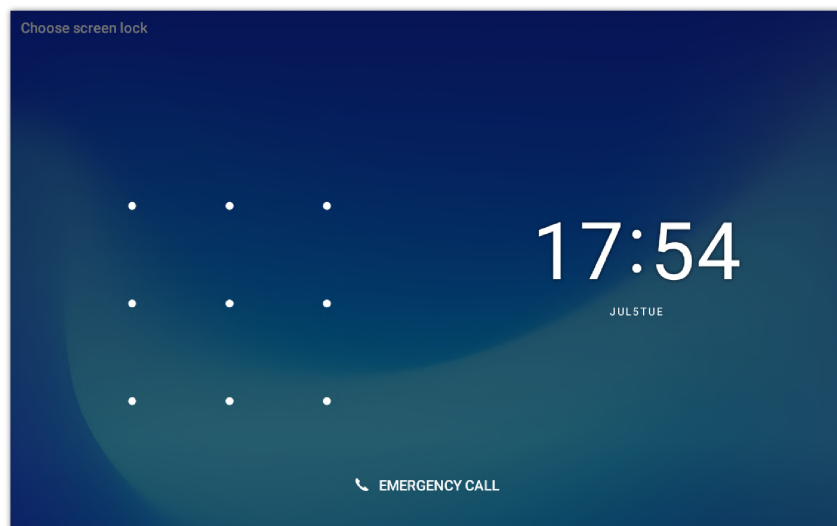

*Locked Screen*

## EMERGENCY CALL

Users could configure Emergency Call Numbers on **GXV34x0 Web GUI** → **Application** → **Contacts** → **General Settings**, in order to still being able to call those numbers even when the phone is locked. Emergency call interface can be accessed by tapping on "EMERGENCY" under the GXV34x0 locked screen. Please, refer to the following figure:

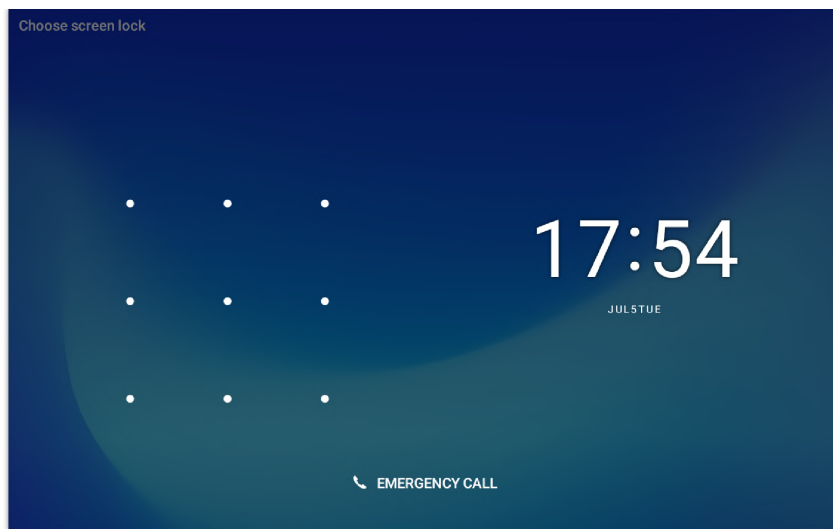

Figure 181: Emergency Access on Locked Screen

Once "EMERGENCY" is pressed, a dial screen will show and users can choose the numbers allowed to be dialed from the list on the left of the dial screen.

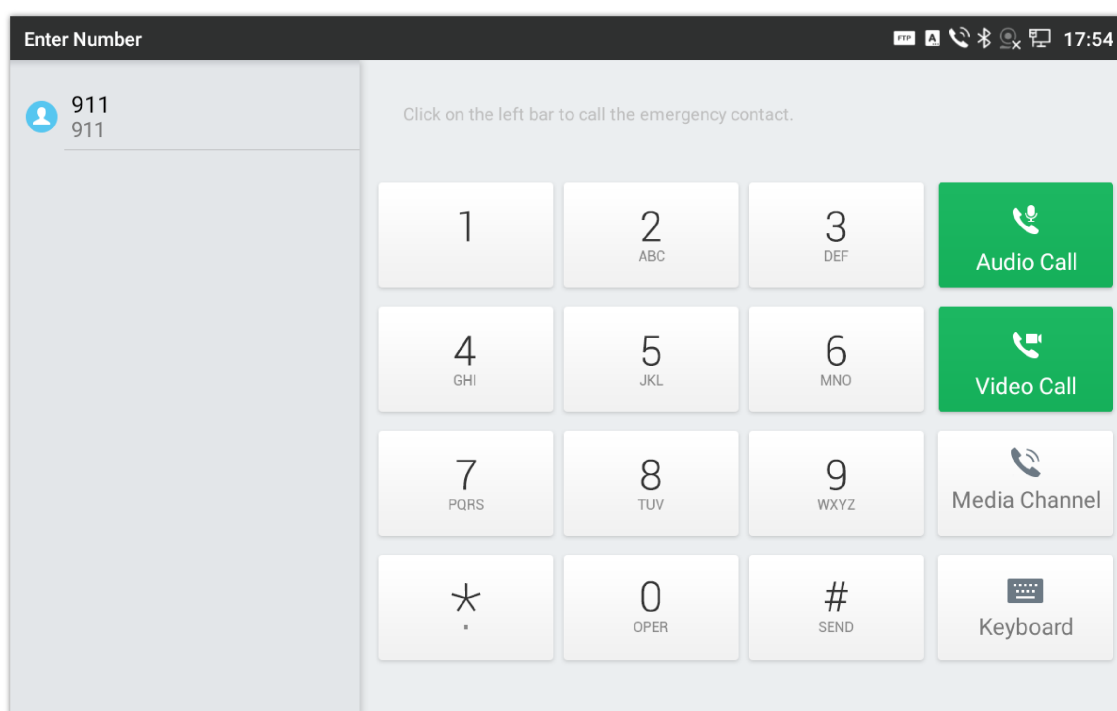

Figure 182: Emergency Dial Screen

The GXV34x0 is not pre-configured to support or carry emergency calls to any type of hospital, law enforcement agency, medical care unit ("Emergency Service(s)") or any other kind of Emergency Service. You must make additional arrangements to access Emergency Services. It is your responsibility to purchase SIP-compliant Internet telephone service, properly configure the GXV34x0 to use that service, and periodically test your configuration to confirm that it works as you expect. If you do not do so, it is your responsibility to purchase traditional wireless or landline telephone services to access Emergency Services.

## EXPERIENCING THE GXV34x0 APPLICATION PHONE

Please visit our website: <https://www.grandstream.com> to receive the most up- to-date updates on firmware releases, additional features, FAQs, documentation and news on new products.

We encourage you to browse our [product related documentation](#), [FAQs](#) and [User and Developer Forum](#) for answers to your general questions. If you have purchased our products through a Grandstream Certified Partner or Reseller, please contact them directly for immediate support.

Our technical support staff is trained and ready to answer all your questions. Contact a technical support member or [submit a trouble ticket online](#) to receive in-depth support.

Thank you again for purchasing Grandstream Enterprise Application phone, it will be sure to bring convenience and color to both your business and personal life.

\* **Android is a trademark of Google LLC.**

\* **Zoom is Registered Trademarks of Zoom Video Communications, Inc.**

**OpenVPN is a registered trademark of OpenVPN Technologies, Inc.**



**HDMI, the HDMI Logo, and High-Definition Multimedia Interface are trademarks or registered trademarks of HDMI Licensing LLC in the United States and other countries.**

## **COPYRIGHT**

©2021 Grandstream Networks, Inc. <https://www.grandstream.com>

All rights reserved. Information in this document is subject to change without notice. Reproduction or transmittal of the entire or any part, in any form or by any means, electronic or print, for any purpose without the express written permission of Grandstream Networks, Inc. is not permitted.

The latest electronic version of this guide is available for download here:

<https://www.grandstream.com/support>

Grandstream is a registered trademark and Grandstream logo is trademark of Grandstream Networks, Inc. in the United States, Europe and other countries.

## **CAUTION**

Changes or modifications to this product not expressly approved by Grandstream, or operation of this product in any way other than as detailed by this guide, could void your manufacturer warranty.

## **WARNING**

Please do not use a different power adaptor with devices as it may cause damage to the products and void the manufacturer warranty.

## **FCC Statement**

This equipment has been tested and found to comply with the limits for a Class B digital device, pursuant to part 15 of the FCC Rules. These limits are designed to provide reasonable protection against harmful interference in a residential installation. This equipment generates, uses and can radiate radio frequency energy and, if not installed and used in accordance with the instructions, may cause harmful interference to radio communications. However, there is no guarantee that interference will not occur in a particular installation.

If this equipment does cause harmful interference to radio or television reception, which can be determined by turning the equipment off and on, the user is encouraged to try to correct the interference by one or more of the following measures:

- Reorient or relocate the receiving antenna.
- Increase the separation between the equipment and receiver.
- Connect the equipment into an outlet on a circuit different from that to which the receiver is connected.
- Consult the dealer or an experienced radio/TV technician for help.

The device complies with FCC radiation exposure limits set forth in an uncontrolled environment and it also complies with Part 15 of the FCC RF Rules. This equipment must be installed and operated in accordance with provided instructions and the antenna(s) used for this transmitter must be installed to provide a separation distance of at least 20 cm from all persons and must not be co-located or operating in conjunction with any other antenna or transmitter. End-users and installers must be provided with antenna installation instructions and consider removing the no-collocation statement.

This device complies with Part 15 of the FCC Rules. Operation is subject to the following two conditions: (1) this device may not cause harmful interference, and (2) this device must accept any interference received, including interference that may cause undesired operation.

**Caution**

Any changes or modification not expressly approved by the party responsible for compliance could void the user's authority to operate the equipment.

**CE DECLARATION OF CONFORMITY**

This transmitter complies with the essential requirements and provisions of directives 2014/53/EU, 2014/30/EU, 2015/35/EU and subsequent amendments, according to standards

Draft ETSI EN 301 489-1 V2.2.1;Draft ETSI EN 301 489-17 V3.2.0;

EN 55032:2015 /AC:2016;EN55035:2017;EN61000-3-3:2013;EN 61000-3-2:2014

ETSI EN 300 328 V2.1.1;ETSI EN 301 893 V2.1.1;EN 62311: 2008;EN 62368-1:2014



**Manufacturer:** Grandstream Networks, Inc.

126 Brookline Ave, 3<sup>rd</sup> Floor Boston, MA 02215, USA

EUT Feature				
<b>Tx/Rx Frequency Range</b>	2402~2480 MHz	2402~2480 MHz	2412~2472 MHz	5150~5250 MHz
				5250~5350 MHz
				5470~5725 MHz



<b>Number of Channels</b>	79	40 (37 hopping + 3 advertising channels)	13	UNII Band I:  802.11a/n-HT20-VHT20: 4 channels  802.11n/ ac -HT40-VHT40: 2 channels  802.11ac-VHT80:1 Channel  UNII Band II:  802.11a/n-HT20-VHT20: 4 channels  802.11n/ ac –HT40–VHT40: 2 channels  802.11ac-VHT80:1 Channel  UNII Band III:  802.11a/n-HT20-VHT20: 11 channels  802.11n/ac-HT40-VHT40: 5 channels  802.11ac-VHT80:2 Channels
<b>Carrier Frequency of Each Channel</b>	f=2402+k MHz  (k=0,1,2...,78)	f=2402+k MHz  (k=0,2,4...,39)	–	–
<b>Antenna Type/Gain</b>	Internal PCB Antenna /  gain 4.0 dBi	Internal PCB Antenna / gain 4.0 dBi	Internal PCB Antenna /  gain 4.0 dBi	Internal PCB Antenna /  gain 5.0 dBi
<b>Type of Modulation</b>	Bluetooth BR 1Mbps: GFSK  Bluetooth EDR 2Mbps: $\pi/4$ -DQPSK  Bluetooth EDR 3Mbps: 8DPSK	Bluetooth LE: GFSK	802.11b: DSSS (DBPSK / DQPSK / CCK)  802.11g/n: OFDM (BPSK / QPSK / 16QAM / 64 QAM)	802.11a/n/ac: OFDM (BPSK / QPSK / 16QAM / 64QAM)
<b>Operation temperature</b>	0 °C ~ +40 °C			
<b>Storage temperature</b>	-10 °C ~ +60 °C			

<b>Humidity</b>	10 ~ 90% non-condensing
<b>Domestic use</b>	Industrial use Class B

**Caution: Exposure to Radio Frequency Radiation**

This equipment complies with EU radiation exposure limits set forth for an uncontrolled environment. This equipment should be installed and operated with minimum distance of 20 cm between the radiator and your body.

**CE Authentication**

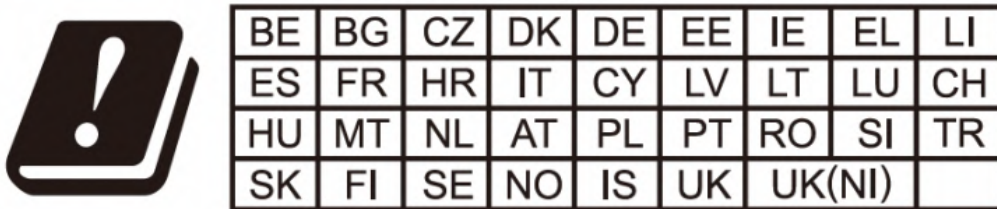

In the UK and EU member states, operation of 5150-5350 MHz is restricted to indoor use only.



**For Certification, Warranty and RMA information, please visit [www.grandstream.com](http://www.grandstream.com)**

Hereby, Grandstream Networks, Inc. declares that the radio equipment GXV34x0 is in compliance with Directive 2014/53/EU.

The full text of the EU declaration of conformity is available at the following internet address:

<https://www.grandstream.com/support/resources/>

**RF Power and Power Adapter Statement**

<b>WLAN</b>		
<b>Standard</b>	<b>Frequency</b>	<b>EIRP Power (dBm)</b>
Wi-Fi 2.4G	2.4~2.4835GHZ	18.70
Wi-Fi 5G	5.15~5.25GHz	22.06
5.25~5.35GHz	19.21	
5.47~5.725GHz	18.24	
<b>Bluetooth</b>		
<b>Bluetooth version</b>	<b>EIRP Power (dBm)</b>	
EDR	12.14	
LE	8.42	

The power adapter is a power-off device.

**GNU GPL INFORMATION**

GXV34x0 firmware contains third-party software licensed under the GNU General Public License (GPL). Grandstream uses software under the specific terms of the GPL. Please see the GNU General Public License (GPL) for the exact terms and conditions of the license.

Grandstream GNU GPL related source code can be downloaded from Grandstream web site from:

<https://blog.grandstream.com/faq/gnu-general-public-license/gnu-gpl-information-download>

## CHANGE LOG

This section documents significant changes from previous versions of user guide for GXV34x0. Only major new features or major document updates are listed here. Minor updates for corrections or editing are not documented here.

### Firmware Version 1.0.3.12

*Product Name: GXV3480, GXV3450, GXV3470*

- Supported disabling desktop widget editing from GUI Config Tool. [[Add Widget to Desktop](#)]
- Added One-click Configuration app on LCD to integrate with GCC device. [[ONE-CLICK CONFIGURATION APP](#)]

### Firmware Version 1.0.3.4

*Product Name: GXV3480 / GXV3450 / GXV3470470*

- Added support for Focus Mode. [[Focus Mode](#)]
- Added support for Call Switch. [[Call Switch](#)]
- Added support for receiving UCM broadcast message in SMS app. [[Broadcast messages](#)]
- Added support for virtual background during the video call. [[Virtual Background](#)]
- Added support for one-key debugging on LCD. [[One-key debugging](#)]
- Added support for echo delay detection and input. [[Echo Delay Adjustment](#)]
- Added support for whiteboard in UCM calls. [[Whiteboard](#)]
- Added support for Dynamic Lock feature. [[Dynamic Lock](#)]
- Added support for full screen layout for video call. [[Full screen](#)]

### Firmware Version 1.0.1.33

*Product Name: GXV3480 / GXV3450 / GXV3470*

- Supported GXV3450 pressing the transfer key can finish the call transfer. [[Call Transfer](#)]

### Firmware Version 1.0.1.29

*Product Name: GXV3480 / GXV3450 / GXV3470*

- Updated Zoom Modules. [[Zoom Mode](#)]

### Firmware Version 1.0.1.21

*Product Name: GXV3480 / GXV3450 / GXV3470*

- Added Support for Zoom Mode. [[Zoom mode](#)]

### Firmware Version 1.0.1.16

*Product Name: GXV3480 / GXV3450*

- No Major Changes.

*Product Name: GXV3470*

- No Major Changes.

### Firmware Version 1.0.1.1

*Product Name: GXV3480 / GXV3450*

- This is the Initial Version.

**Firmware Version 1.0.0.4**

*Product Name: GXV3470*

- This is the Initial Version.

**Need Support?**

Can't find the answer you're looking for? Don't worry we're here to help!

[CONTACT SUPPORT](#)