

Grandstream Networks, Inc.

**GRP261x/GRP262x/GRP263x/GRP2650/  
GRP2670 Series - User Guide**



Thank you for purchasing Grandstream GRP261X/GRP2624/GRP2634/GRP2636/GRP2650 & GRP2670 Carrier-Grade IP Phones.

The GRP26xx Professional Carrier-Grade IP Phones offer top-notch HD audio quality as well as a variety of telephony features. This series was designed for mass deployment and broad interoperability with most 3rd party SIP devices and platforms. With its sleek design, re-conceptualized user experience, the GRP26xx series comes with powerful out-of-the-box feature options including Bluetooth & Wi-Fi support dual LCD screen, support for up to 14 lines, 5-way conferencing for all models, and customizable face-plates for a touch of personalization. In addition to all the mentioned characteristics, the series is compatible with Grandstream’s cloud provisioning platform, GDMS (Grandstream Device Management System) for remote and cloud provisioning purposes. The GRP26xx is the perfect choice for enterprises looking for IP phones with advanced functionalities that are also easy to use and deploy.

## PRODUCT OVERVIEW

### Feature Highlights

The following tables contain the major features of the GRP261X/GRP2624/GRP2634/GRP2636/GRP2670/GRP2650:

 <p><b>GRP2612</b> <b>GRP2612P</b> <b>GRP2612W</b> <b>GRP2612G</b></p>	<ul style="list-style-type: none"> <li>• 4 dual-color line keys (can be digitally programmed as up to 16 provisionable BLF/fast-dial keys)</li> <li>• 2.4” (320×240) TFT color LCD.</li> <li>• 4 programmable context-sensitive soft keys.</li> <li>• 100M network ports. (1000M for GRP2612G)</li> <li>• Integrated PoE (GRP2612P, GRP2612G &amp; GRP2612W only).</li> <li>• 5-way conference.</li> <li>• Electronic Hook Switch (EHS).</li> <li>• Wi-Fi support (GRP2612W only).</li> </ul>
 <p><b>GRP2613</b></p>	<ul style="list-style-type: none"> <li>• 6 dual-color line keys (can be digitally programmed as up to 24 provisionable BLF/fast-dial keys).</li> <li>• 2.8” (320×240) TFT color LCD.</li> <li>• 4 programmable context-sensitive soft keys.</li> <li>• 1000M network ports.</li> <li>• 5-way conference.</li> <li>• integrated PoE.</li> <li>• Electronic Hook Switch (EHS).</li> </ul>
 <p><b>GRP2614</b></p>	<ul style="list-style-type: none"> <li>• 4 dual-color line keys (can be digitally programmed as up to 16 provisionable BLF/fast-dial keys).</li> <li>• 2.8” (320×240) TFT color LCD.</li> <li>• 4 programmable context-sensitive soft keys</li> <li>• 2.4” (320×240) additional screen dedicated to up to 24 multi-purpose keys.</li> <li>• 1000M network ports.</li> <li>• Integrated PoE.</li> <li>• Wi-Fi and Bluetooth support.</li> <li>• 5-way conference.</li> <li>• Electronic Hook Switch (EHS).</li> </ul>



**GRP2615**

- 10 dual-color line keys (can be digitally programmed as up to 40 provisionable BLF/fast-dial keys).
- 4.3" (480×272) TFT color LCD.
- 5 programmable context-sensitive soft keys.
- 1000M network ports.
- Integrated PoE.
- Wi-Fi and Bluetooth support.
- 5-way conference.
- Electronic Hook Switch (EHS).



**GRP2616**

- 6 dual-color line keys (can be digitally programmed as up to 24 provisionable BLF/fast-dial keys).
- 4.3" (480×272) TFT color LCD.
- 5 programmable context-sensitive soft keys.
- 2.4" (320×240) additional screen dedicated to up to 24 multi-purpose keys.
- 1000M network ports.
- Integrated PoE.
- Wi-Fi and Bluetooth support.
- 5-way conference.
- Electronic Hook Switch (EHS).



**GRP2624**

- 8 dual-color line keys (can be digitally programmed as up to 24 provisionable BLF/fast-dial keys).
- 2.8 inch (320×240) TFT color LCD.
- 4 programmable context-sensitive soft keys.
- 2.4" (320×240) additional screen dedicated to up to 24 multi-purpose keys.
- 1000M network ports.
- Integrated PoE.
- Wi-Fi and Bluetooth support.
- 5-way conference.
- Electronic Hook Switch (EHS).



**GRP2634**

- 8 dual-color line keys (can be digitally programmed as up to 24 provisional BLF/fast-dial keys).
- 2.8 inch (320×240) TFT color LCD.
- 4 programmable context-sensitive soft keys.
- 2.4" (320×240) additional screen dedicated to up to 24 multi-purpose keys.
- 1000M network ports.
- Integrated PoE.
- Wi-Fi and Bluetooth support.
- 5-way conference.



**GRP2636**

- 12 lines with up to 6 SIP Accounts
- 24 dual-color line keys (can be digitally programmed as up to 24 provisional BLF/fast-dial keys).
- 4.3inch(480x272) TFT color LCD.
- 5 programmable context-sensitive soft keys.
- 1000M network ports.
- Wi-Fi and Bluetooth support.
- 5-way conference.



**GRP2670**

- 12 lines with up to 6 SIP Accounts
- 7" (1042x600) capacitive touch TFT color LCD.
- 1000M network ports.
- Integrated PoE.
- Wi-Fi and Bluetooth support.
- 5-way conference.



**GRP2650**

- 14 line keys with up to 6 SIP accounts (With 56 Virtual Multi-Purpose Keys (VPK))
- 5.0 inch (1280x720) TFT color LCD
- 6 XML programmable context sensitive softkeys
- Dual switched auto-sensing 10/100/1000 Mbps
- Integrated PoE
- Wi-Fi and Bluetooth support
- 5-way conference.

Features	GRP2612 GRP2612P GRP2612W GRP2612G	GRP2613	GRP2614	GRP2615	GRP2616	GRP2624	GRP2634	GRP2636	GRP2670	GRP2650
<b>LCD Display</b>	320x240	320x240	320x240	480x272	480x272	320x240	320x240	480x272	1024x600	1280x720
<b>LCD Backlight</b>	Yes	Yes	Yes	Yes	Yes	Yes	Yes	Yes	Yes	Yes
<b>Electronic Hook Switch</b>	Yes	Yes	Yes	Yes	Yes	Yes	Yes	Yes	Yes	Yes
<b>Number of Lines</b>	4	6	4	10	6	8	8	12	12	14
<b>Programmable Hard Keys</b>	16	24	16	40	24	32	32	36	48 (VPKs)	56 (VPKs)
<b>Programmable Soft Keys</b>	4	4	4	5	5	4	4	5	3	6
<b>MPK LCD</b>	No	No	Yes	No	Yes	No	No	No	No	No
<b>PoE</b>	GRP2612P/ GRP2612G/ GRP2612W only	Yes	Yes	Yes	Yes	Yes	Yes	Yes	Yes	Yes
<b>Network ports</b>	100M (1000M for GRP2612G)	1000M	1000M	1000M	1000M	1000M	1000M	1000M	1000M	1000M
<b>Conference</b>	5-way	5-way	5-way	5-way	5-way	5-way	5-way	5-way	5-way	5-way
<b>Bluetooth</b>	No	No	Yes	Yes	Yes	Yes	Yes	Yes	Yes	Yes
<b>Wi-Fi</b>	GRP2612W only	No	Yes	Yes	Yes	Yes	Yes	Yes	Yes	Yes

*GRP261X/GRP2624/GRP2634/GRP2636/GRP2650/GRP2670 Features at a glance*

## Technical Specifications

The following table resumes all the technical specifications including the protocols/standards supported, voice codecs, telephony features, languages, and upgrade/provisioning settings for the GRP261X/GRP2624/GRP2634/GRP2636/GRP2670/GRP2650 series.



<b>Protocols/Standards</b>	SIP RFC3261, TCP/IP/UDP, RTP/RTCP/RTCP-XR, HTTP/HTTPS, ARP, ICMP, DNS (A record, SRV, NAPTR), DHCP, PPPoE, SSH, TFTP, FTP/FTPS, NTP, STUN, SIMPLE, LLDP, LDAP, TR-069, 802.1x, TLS, SRTP, IPv6
<b>Network Interfaces</b>	Dual switched auto-sensing 10/100 Mbps Ethernet ports (GRP2612) Dual switched auto-sensing 10/100 Mbps Ethernet ports with integrated PoE (GRP2612P & GRP2612W) Dual switched auto-sensing 10/100/1000 Mbps Gigabit Ethernet ports with integrated PoE (GRP2612G)
<b>Graphic Display</b>	2.4 inch (320×240) TFT color LCD
<b>Feature Keys</b>	4 line keys with up to 4 SIP accounts and up to 2 SIP accounts for legacy hardware (discontinued in 2020), 4 programmable contexts sensitive Softkeys, 5 navigation/menu keys, 9 dedicated function keys for: MESSAGE (with LED indicator), TRANSFER, HOLD, HEADSET, MUTE, SEND/REDIAL, SPEAKERPHONE, VOLUME+, VOLUME-
<b>Voice Codec</b>	Support for G.729A/B, G723.1, G.711μ/a-law, G.726, G.722 (wide-band), OPUS, iLBC and in-band and out-of-band DTMF (in audio, RFC2833, SIP INFO)
<b>Auxiliary Ports</b>	RJ9 headset jack (allowing EHS with Plantronics headsets)
<b>Telephony Features</b>	Hold, transfer, forward, 5-way conference, call park, call pickup, shared-call-appearance (SCA), bridged-line-appearance (BLA), downloadable phonebook (XML, LDAP, up to 1000 items), call waiting, call log (up to 2000 records), customization of screen, off-hook auto dial, auto answer, click-to-dial, flexible dial plan, hot desking, personalized music ringtones and music on hold, server redundancy and fail-over
<b>HD audio</b>	Yes, both on handset and full-duplex handsfree speakerphone
<b>Base Stand</b>	Yes, allow 2 angle positions
<b>Wall Mountable</b>	Yes, (*wall mount sold separately)
<b>QoS</b>	Layer 2 (802.1Q, 802.1p) and Layer 3 (ToS, DiffServ, MPLS) QoS
<b>Security</b>	User and administrator level passwords, MD5 and MD5-sess based authentication, AES based secure configuration file, SRTP, TLS, 802.1x media access control
<b>Multi-language</b>	<b>LCD Language:</b> English 简体中文 (Simplified Chinese) العربية (Arabic) Català (Catalan) Čeština (Czech) Deutsch (German) Ελληνικά (Greek) Español (Spanish) Français (French) עברית (Hebrew) Hrvatski (Croatian) Magyar (Hungarian) Italiano (Italian) 日本語 (Japanese) 한국어 (Korean) Latviešu valoda (Latvian) Nederlands (Dutch) Polski (Polish) Português (Portuguese) Русский (Russian) Svenska (Swedish) Slovenščina (Slovenian) Slovenčina (Slovak) Türkçe (Turkish) Українська (Ukrainian) 正體中文 (Traditional Chinese) <b>WebUI Language:</b> English 简体中文 (Simplified Chinese) العربية (Arabic) Čeština (Czech) Deutsch (German) Español (Spanish) Français (French) עברית (Hebrew) Hrvatski (Croatian) Magyar (Hungarian) Italiano (Italian) 日本語 (Japanese) 한국어 (Korean) Nederlands (Dutch) Polski (Polish) Português (Portuguese) Русский (Russian) Slovenščina (Slovenian) Türkçe (Turkish) 繁體中文 (Traditional Chinese)
<b>Upgrade/Provisioning</b>	Firmware upgrade via TFTP/FTP/FTPS/HTTP/HTTPS, mass provisioning using TR-069 or encrypted XML configuration file
<b>Power &amp; Green Energy Efficiency</b>	Universal power adapter included: Input:100-240 VAC; Output: +5VDC, 0.5A; Integrated Power-over-Ethernet (802.3af)
<b>Physical</b>	Dimension : 203mm x 193mm x 52.1mm Unit weight : 554g Package weight : 936g
<b>Temperature and Humidity</b>	32-104°F / 0 ~ 40°C, 10-90% (non- condensing)
<b>Package Content</b>	GRP2612/GRP2612P/GRP2612W/GRP2612G phone, handset with cord, base stand, universal power supply

	(except GRP2612P), network cable, Quick Installation Guide
<b>Compliance</b>	<p><b>GRP2612/GRP2612P/GRP2612G:</b>  FCC: Part 15 Class B; FCC Part 68 HAC.  CE: EN 55032; EN 55035; EN 61000-3-2; EN 61000-3-3; EN IEC 62368-1.  RCM: AS/NZS CISPR 32; AS/NZS 62368.1; AS/CA S004  IC: ICES-003; CS-03, Part V.</p> <p><b>GRP2612W:</b>  FCC: Part 15 Class B; Part 15 Subpart C, 15.247; Part 15 Subpart E, 15.407; FCC Part 68 HAC.  CE: EN 55032; EN 55035; EN IEC 61000-3-2; EN 61000-3-3; EN IEC 62368-1; EN 301 489-1; EN 301 489-17;  EN 300 328; EN 301 893; EN 62311.  RCM: AS/NZS CISPR 32; AS/NZS 62368.1; AS/NZS 4268; AS/NZS 2772.2; AS/CA S004.  IC: ICES-003; CS-03, Part V; RSS-247; RSS-102.</p>

*GRP2612/GRP2612P/GRP2612W/GRP2612G Technical Specifications*

<b>Protocols/Standards</b>	SIP RFC3261, TCP/IP/UDP, RTP/RTCP/RTCP-XR, HTTP/HTTPS, ARP, ICMP, DNS (A record, SRV, NAPTR), DHCP, PPPoE, SSH, TFTP, FTP/FTPS, NTP, STUN, SIMPLE, LLDP, LDAP, TR-069, 802.1x, TLS, SRTP, IPv6
<b>Network Interfaces</b>	Dual switched auto-sensing 10/100/1000 Mbps Ethernet ports with integrated PoE
<b>Graphic Display</b>	2.8 inch (320x240) TFT color LCD – 2.4 inch MPK color LCD
<b>Feature Keys</b>	6 line keys with up to 4 SIP accounts and up to 3 SIP accounts for legacy hardware (discontinued in 2020), 5 navigation/menu keys, 9 dedicated function keys for: MESSAGE (with LED indicator), TRANSFER, HOLD, HEADSET, MUTE, SEND/REDIAL, SPEAKERPHONE, VOLUME+, VOLUME-
<b>Voice Codec</b>	Support for G.729A/B, G.711μ/a-law, G.726, G.722 (wide-band), OPUS, iLBC and in-band and out-of-band DTMF (in audio, RFC2833, SIP INFO)
<b>Auxiliary Ports</b>	RJ9 headset jack (allowing EHS with Plantronics headsets), USB port.
<b>Telephony Features</b>	Hold, transfer, forward, 5-way conference, call park, call pickup, shared-call-appearance (SCA)/bridged-line-appearance (BLA), downloadable phonebook (XML, LDAP, up to 2000 items), call waiting, call log (up to 2000 records), customization of screen, off-hook auto dial, auto answer, click-to-dial, flexible dial plan, Hot Desking, personalized music ringtones and music on hold, server redundancy and fail-over
<b>HD audio</b>	Yes, both on handset and full-duplex handsfree speakerphone
<b>Base Stand</b>	Yes, allow 2 angle positions
<b>Wall Mountable</b>	Yes, (*wall mount sold separately)
<b>QoS</b>	Layer 2 (802.1Q, 802.1p) and Layer 3 (ToS, DiffServ, MPLS) QoS
<b>Security</b>	User and administrator level passwords, MD5 & MD5-sess based authentication, AES based secure configuration file, SRTP, TLS, 802.1x media access control
<b>Multi-language</b>	<p><b>LCD Language:</b> English 简体中文 (Simplified Chinese) العربية (Arabic) Català (Catalan) Čeština (Czech) Deutsch (German) Ελληνικά (Greek) Español (Spanish) Français (French) עברית (Hebrew) Hrvatski (Croatian) Magyar (Hungarian) Italiano (Italian) 日本語 (Japanese) 한국어 (Korean) Latviešu valoda (Latvian) Nederlands (Dutch) Polski (Polish) Português (Portuguese) Русский (Russian) Svenska (Swedish) Slovenščina (Slovenian) Slovenčina (Slovak) Türkçe (Turkish) Українська (Ukrainian) 正體中文 (Traditional Chinese)</p> <p><b>WebUI Language:</b> English 简体中文 (Simplified Chinese) العربية (Arabic) Čeština (Czech) Deutsch (German) Español (Spanish) Français (French) עברית (Hebrew) Hrvatski (Croatian) Magyar (Hungarian) Italiano (Italian) 日本語 (Japanese) 한국어 (Korean) Nederlands (Dutch) Polski (Polish) Português (Portuguese) Русский (Russian) Slovenščina (Slovenian) Türkçe (Turkish) 繁體中文 (Traditional Chinese)</p>
<b>Upgrade/Provisioning</b>	Firmware upgrade via TFTP/FTP/FTPS/HTTP/HTTPS, mass provisioning using TR-069 or encrypted XML configuration file

<b>Power &amp; Green Energy Efficiency</b>	Universal power adapter included: Input:100-240V; Output: +12V, 0.5A; Integrated Power-over-Ethernet (802.3af) Max power consumption: 6W
<b>Physical</b>	Dimension : 203mm x 193mm x 52.1mm Unit weight : 554g Package weight : 936g
<b>Temperature and Humidity</b>	32-104°F / 0 ~ 40°C, 10-90% (non- condensing)
<b>Package Content</b>	GRP2613 phone, handset with cord, base stand, universal power supply, network cable, Quick Installation Guide
<b>Compliance</b>	FCC: FCC Part 15B, Class B; FCC Part 15 Subpart C; FCC Part 15 Subpart E; FCC Part 68 HAC. CE: EN 55032; EN 55035; EN 61000-3-2; EN 61000-3-3; EN 62368-1; EN 301 489-1/-17; EN 300 328; EN 301 893; EN 62311; RCM: AS/NZS CISPR 32; AS/NZS 60950.1; AS/NZS 4268; AS/CA S004.

*GRP2613 Technical Specifications*

<b>Protocols/Standards</b>	SIP RFC3261, TCP/IP/UDP, RTP/RTCP/RTCP-XR, HTTP/HTTPS, ARP, ICMP, DNS (A record, SRV, NAPTR), DHCP, PPPoE, SSH, TFTP, FTP/FTPS, NTP, STUN, SIMPLE, LLDP, LDAP, TR-069, 802.1x, TLS, SRTP, IPv6
<b>Network Interfaces</b>	Dual switched auto-sensing 10/100/1000 Mbps Ethernet ports with integrated PoE
<b>Graphic Display</b>	2.8 inch (320×240) TFT color LCD – 2.4 inch MPK color LCD
<b>Bluetooth</b>	Yes, Bluetooth integrated
<b>Wi-Fi</b>	Yes, dual-band
<b>Feature Keys</b>	4 line keys with up to 4 SIP accounts, 24 speed-dial/BLF extension keys with dual-color LED, 4 programmable contexts sensitive Softkeys, 5 navigation/menu keys, 11 dedicated function keys for: MESSAGE (with LED indicator), PHONEBOOK, TRANSFER, CONFERENCE, HOLD, HEADSET, MUTE, SEND/REDIAL, SPEAKERPHONE, VOLUME+, VOLUME-
<b>Voice Codec</b>	Support for G.729A/B, G.711μ/a-law, G.726, G.722 (wide-band), OPUS, iLBC and in-band and out-of-band DTMF (in audio, RFC2833, SIP INFO)
<b>Auxiliary Ports</b>	RJ9 headset jack (allowing EHS with Plantronics headsets).
<b>Telephony Features</b>	Hold, transfer, forward, 5-way conference, call park, call pickup, shared-call-appearance (SCA)/bridged-line-appearance (BLA), downloadable phonebook (XML, LDAP, up to 2000 items), call waiting, call log (up to 2000 records), customization of screen, off-hook auto dial, auto answer, click-to-dial, flexible dial plan, Hot Desking, personalized music ringtones and music on hold, server redundancy and fail-over
<b>HD audio</b>	Yes, both on handset and full-duplex handsfree speakerphone
<b>Base Stand</b>	Yes, allow 2 angle positions
<b>Wall Mountable</b>	Yes, (*wall mount sold separately)
<b>QoS</b>	Layer 2 (802.1Q, 802.1p) and Layer 3 (ToS, DiffServ, MPLS) QoS
<b>Security</b>	User and administrator level passwords, MD5 & MD5-sess based authentication, AES based secure configuration file, SRTP, TLS, 802.1x media access control
<b>Multi-language</b>	<b>LCD Language:</b> English 简体中文 (Simplified Chinese) العربية (Arabic) Català (Catalan) Čeština (Czech) Deutsch (German) Ελληνικά (Greek) Español (Spanish) Français (French) עברית (Hebrew) Hrvatski (Croatian) Magyar (Hungarian) Italiano (Italian) 日本語 (Japanese) 한국어 (Korean) Latviešu valoda (Latvian) Nederlands (Dutch) Polski (Polish) Português (Portuguese) Русский (Russian) Svenska (Swedish) Slovenščina (Slovenian) Slovenčina

	(Slovak) Türkçe (Turkish) Українська (Ukrainian) 正體中文 (Traditional Chinese) <b>WebUI Language:</b> English 简体中文 (Simplified Chinese) العربية (Arabic) Čeština (Czech) Deutsch (German) Español (Spanish) Français (French) עברית (Hebrew) Hrvatski (Croatian) Magyar (Hungarian) Italiano (Italian) 日本語 (Japanese) 한국어 (Korean) Nederlands (Dutch) Polski (Polish) Português (Portuguese) Русский (Russian) Slovenščina (Slovenian) Türkçe (Turkish) 繁體中文 (Traditional Chinese)
<b>Upgrade/Provisioning</b>	Firmware upgrade via TFTP/FTP/FTPS/HTTP/HTTPS, mass provisioning using TR-069 or encrypted XML configuration file
<b>Power &amp; Green Energy Efficiency</b>	Universal power adapter included: Input:100-240V; Output: +12V, 0.5A; Integrated Power-over-Ethernet (802.3af) Max power consumption: 6W
<b>Physical</b>	Dimension : 234mm x 213mm x 82.2mm Unit weight : 950g Package weight : 1460g
<b>Temperature and Humidity</b>	32-104°F / 0 ~ 40°C, 10-90% (non- condensing)
<b>Package Content</b>	GRP2614 phone, handset with cord, base stand, universal power supply, network cable, Quick Installation Guide
<b>Compliance</b>	FCC: FCC Part 15B, Class B; FCC Part 15 Subpart C; FCC Part 15 Subpart E; FCC Part 68 HAC. CE: EN 55032; EN 55035; EN 61000-3-2; EN 61000-3-3; EN 62368-1; EN 301 489-1/-17; EN 300 328; EN 301 893; EN 62311; RCM: AS/NZS CISPR 32; AS/NZS 60950.1; AS/NZS 4268; AS/CA S004.

#### *GRP2614 Technical Specifications*

<b>Protocols/Standards</b>	SIP RFC3261, TCP/IP/UDP, RTP/RTCP/RTCP-XR, HTTP/HTTPS, ARP, ICMP, DNS (A record, SRV, NAPTR), DHCP, PPPoE, SSH, TFTP, FTP/FTPS, NTP, STUN, SIMPLE, LLDP, LDAP, TR-069, 802.1x, TLS, SRTP, IPv6
<b>Network Interfaces</b>	Dual switched auto-sensing 10/100/1000 Mbps Ethernet ports with integrated PoE
<b>Graphic Display</b>	4.3 inch (480×272) TFT color LCD – 2.4 inch MPK color LCD
<b>Bluetooth</b>	Yes, Bluetooth integrated
<b>Wi-Fi</b>	Yes, dual-band
<b>Feature Keys</b>	10 line keys with up to 5 SIP accounts, 40 speed-dial/BLF extension keys with dual-color LED, 5 programmable contexts sensitive Softkeys, 5 navigation/menu keys, 9 dedicated function keys for: MESSAGE (with LED indicator), TRANSFER, HOLD, HEADSET, MUTE, SEND/REDIAL, SPEAKERPHONE, VOLUME+, VOLUME-
<b>Voice Codec</b>	Support for G.729A/B, G.711μ/a-law, G.726, G.722 (wide-band), OPUS, iLBC and in-band and out-of-band DTMF (in audio, RFC2833, SIP INFO)
<b>Auxiliary Ports</b>	RJ9 headset jack (allowing EHS with Plantronics headsets), USB port.
<b>Telephony Features</b>	Hold, transfer, forward, 5-way conference, call park, call pickup, shared-call-appearance (SCA)/bridged-line-appearance (BLA), downloadable phonebook (XML, LDAP, up to 2000 items), call waiting, call log (up to 2000 records), customization of screen, off-hook auto dial, auto answer, click-to-dial, flexible dial plan, Hot Desking, personalized music ringtones and music on hold, server redundancy and fail-over
<b>HD audio</b>	Yes, both on handset and full-duplex handsfree speakerphone
<b>Base Stand</b>	Yes, allow 2 angle positions
<b>Wall Mountable</b>	Yes, (*wall mount sold separately)

<b>QoS</b>	Layer 2 (802.1Q, 802.1p) and Layer 3 (ToS, DiffServ, MPLS) QoS
<b>Security</b>	User and administrator level passwords, MD5 & MD5-session based authentication, AES based secure configuration file, SRTP, TLS, 802.1x media access control
<b>Multi-language</b>	<p><b>LCD Language:</b> English 简体中文 (Simplified Chinese) العربية (Arabic) Català (Catalan) Čeština (Czech) Deutsch (German) Ελληνικά (Greek) Español (Spanish) Français (French) עברית (Hebrew) Hrvatski (Croatian) Magyar (Hungarian) Italiano (Italian) 日本語 (Japanese) 한국어 (Korean) Latviešu valoda (Latvian) Nederlands (Dutch) Polski (Polish) Português (Portuguese) Русский (Russian) Svenska (Swedish) Slovenščina (Slovenian) Slovenčina (Slovak) Türkçe (Turkish) Українська (Ukrainian) 正體中文 (Traditional Chinese)</p> <p><b>WebUI Language:</b> English 简体中文 (Simplified Chinese) العربية (Arabic) Čeština (Czech) Deutsch (German) Español (Spanish) Français (French) עברית (Hebrew) Hrvatski (Croatian) Magyar (Hungarian) Italiano (Italian) 日本語 (Japanese) 한국어 (Korean) Nederlands (Dutch) Polski (Polish) Português (Portuguese) Русский (Russian) Slovenščina (Slovenian) Türkçe (Turkish) 繁體中文 (Traditional Chinese)</p>
<b>Upgrade/Provisioning</b>	Firmware upgrade via TFTP/FTP/FTPS/HTTP/HTTPS, mass provisioning using TR-069 or encrypted XML configuration file
<b>Power &amp; Green Energy Efficiency</b>	Universal power adapter included: Input:100-240V; Output: +12V, 0.5A; Integrated Power-over-Ethernet (802.3af)
<b>Physical</b>	Dimensions : 243mm x 210mm x 82.3mm Unit weight:970g Package weight:1480g
<b>Temperature and Humidity</b>	32-104°F / 0 ~ 40°C, 10-90% (non- condensing)
<b>Package Content</b>	GRP2615 phone, handset with cord, base stand, universal power supply, network cable, Quick Installation Guide
<b>Compliance</b>	FCC: FCC Part 15B, Class B; FCC Part 15 Subpart C; FCC Part 15 Subpart E; FCC Part 68 HAC. CE: EN 55032; EN 55035; EN 61000-3-2; EN 61000-3-3; EN 62368-1; EN 301 489-1/-17; EN 300 328; EN 301 893; EN 62311; RCM: AS/NZS CISPR 32; AS/NZS 60950.1; AS/NZS 4268; AS/CA S004.

*GRP2615 Technical Specifications*

<b>Protocols/Standards</b>	SIP RFC3261, TCP/IP/UDP, RTP/RTCP/RTCP-XR, HTTP/HTTPS, ARP, ICMP, DNS (A record, SRV, NAPTR), DHCP, PPPoE, SSH, TFTP, FTP/FTPS, NTP, STUN, SIMPLE, LLDP, LDAP, TR-069, 802.1x, TLS, SRTP, IPv6
<b>Network Interfaces</b>	Dual switched auto-sensing 10/100/1000 Mbps Ethernet ports with integrated PoE
<b>Graphic Display</b>	4.3 inch (480×272) TFT color LCD – 2.4 inch MPK color LCD
<b>Bluetooth</b>	Yes, Bluetooth integrated
<b>Wi-Fi</b>	Yes, dual-band
<b>Feature Keys</b>	6 line keys with up to 6 SIP accounts, 24 speed-dial/BLF extension keys with dual-color LED, 5 programmable contexts sensitive Softkeys, 5 navigation/menu keys, 11 dedicated function keys for: MESSAGE (with LED indicator), PHONEBOOK, TRANSFER, CONFERENCE, HOLD, HEADSET, MUTE, SEND/REDIAL, SPEAKERPHONE, VOLUME+, VOLUME-
<b>Voice Codec</b>	Support for G.729A/B, G.711μ/a-law, G.726, G.722 (wide-band), OPUS, iLBC and in-band and out-of-band DTMF (in audio, RFC2833, SIP INFO)
<b>Auxiliary Ports</b>	RJ9 headset jack (allowing EHS with Plantronics headsets), USB port.
<b>Telephony Features</b>	Hold, transfer, forward, 5-way conference, call park, call pickup, shared-call-appearance (SCA)/bridged-line-appearance (BLA), downloadable phonebook (XML, LDAP, up to 2000 items), call waiting, call log (up to 2000

	records), customization of screen, off-hook auto dial, auto answer, click-to-dial, flexible dial plan, Hot Desking, personalized music ringtones and music on hold, server redundancy and fail-over.
<b>HD audio</b>	Yes, both on handset and full-duplex handsfree speakerphone
<b>Base Stand</b>	Yes, allow 2 angle positions
<b>Wall Mountable</b>	Yes
<b>QoS</b>	Layer 2 (802.1Q, 802.1p) and Layer 3 (ToS, DiffServ, MPLS) QoS
<b>Security</b>	User and administrator level passwords, MD5 & MD5-sess based authentication, AES based secure configuration file, SRTP, TLS, 802.1x media access control
<b>Multi-language</b>	<b>LCD Language:</b> English 简体中文 (Simplified Chinese) العربية (Arabic) Català (Catalan) Čeština (Czech) Deutsch (German) Ελληνικά (Greek) Español (Spanish) Français (French) עברית (Hebrew) Hrvatski (Croatian) Magyar (Hungarian) Italiano (Italian) 日本語 (Japanese) 한국어 (Korean) Latviešu valoda (Latvian) Nederlands (Dutch) Polski (Polish) Português (Portuguese) Русский (Russian) Svenska (Swedish) Slovenščina (Slovenian) Slovenčina (Slovak) Türkçe (Turkish) Українська (Ukrainian) 正體中文 (Traditional Chinese) <b>WebUI Language:</b> English 简体中文 (Simplified Chinese) العربية (Arabic) Čeština (Czech) Deutsch (German) Español (Spanish) Français (French) עברית (Hebrew) Hrvatski (Croatian) Magyar (Hungarian) Italiano (Italian) 日本語 (Japanese) 한국어 (Korean) Nederlands (Dutch) Polski (Polish) Português (Portuguese) Русский (Russian) Slovenščina (Slovenian) Türkçe (Turkish) 繁體中文 (Traditional Chinese)
<b>Upgrade/Provisioning</b>	Firmware upgrade via TFTP/FTP/FTPS/HTTP/HTTPS, mass provisioning using TR-069 or encrypted XML configuration file
<b>Power &amp; Green Energy Efficiency</b>	Universal power adapter included: Input:100-240V; Output: +12V, 0.5A; Integrated Power-over-Ethernet (802.3af)
<b>Temperature and Humidity</b>	32-104°F / 0 ~ 40°C, 10-90% (non- condensing)
<b>Package Content</b>	GRP2616 phone, handset with cord, base stand, universal power supply, network cable, Quick Installation Guide
<b>Compliance</b>	FCC: FCC Part 15B, Class B; FCC Part 15 Subpart C; FCC Part 15 Subpart E; FCC Part 68 HAC. CE: EN 55032; EN 55035; EN 61000-3-2; EN 61000-3-3; EN 62368-1; EN 301 489-1/-17; EN 300 328; EN 301 893; EN 62311; RCM: AS/NZS CISPR 32; AS/NZS 60950.1; AS/NZS 4268; AS/CA S004.

*GRP2616 Technical Specifications*

<b>Protocols/Standards</b>	SIP RFC3261, TCP/IP/UDP, RTP/RTCP/RTCP-XR, HTTP/HTTPS, ARP, ICMP, DNS (A record, SRV, NAPTR), DHCP, PPPoE, SSH, TFTP, FTP/FTPS, NTP, STUN, SIMPLE, LLDP, LDAP, TR-069, 802.1x, TLS, SRTP, IPv6
<b>Network Interfaces</b>	Dual switched auto-sensing 10/100/1000 Mbps Ethernet ports with integrated PoE
<b>Graphic Display</b>	2.8 inch (320×240) TFT color LCD
<b>Bluetooth</b>	Yes, Bluetooth integrated
<b>Wi-Fi</b>	Yes, dual-band
<b>Feature Keys</b>	8 line keys with up to 6 SIP accounts and up to 4 SIP accounts for legacy hardware (discontinued in 2020), 4 XML programmable context sensitive softkeys, 5 navigation/menu keys, 9 dedicated function keys for: MESSAGE(with LED indicator), TRANSFER, HOLD, HEADSET, MUTE, SEND/REDIAL, SPEAKERPHONE, VOL+, VOL-
<b>Voice Codec</b>	Support for G.729A/B, G.711μ/a-law, G.726, G.722 (wide-band), OPUS, iLBC and in-band and out-of-band DTMF (in audio, RFC2833, SIP INFO)

<b>Auxiliary Ports</b>	RJ9 headset jack allowing EHS with Plantronics headsets, USB to support Grandstream's GUV Series headsets and other USB headsets
<b>Telephony Features</b>	Hold, transfer, forward, 5-way conference, call park, call pickup, shared-callappearance(SCA)/bridged-line-appearance(BLA), downloadable phonebook(XML, LDAP, up to 2000 items), call waiting, call log(up to 2000 records), XML customization of screen, off-hook auto dial, auto answer, click-to-dial, flexible dial plan, hot-desking, personalized music ringtones and music on hold, server redundancy and fail-over
<b>HD audio</b>	Yes, HD handset and speakerphone with support for wideband audio, and dual microphone.
<b>Base Stand</b>	Yes, 2 angle positions available, Wall Mountable (Wall Mount *sold separately)
<b>Wall Mountable</b>	Yes
<b>QoS</b>	Layer 2 QoS (802.1Q, 802.1P) and Layer 3 (ToS, DiffServ, MPLS) QoS
<b>Security</b>	User and administrator level passwords, MD5 and MD5-sess based authentication, 256-bit AES encrypted configuration file, SRTP, TLS, 802.1x media access control, secure boot.
<b>Multi-language</b>	
<b>Upgrade/Provisioning</b>	Firmware upgrade via FTP/TFTP / HTTP / HTTPS, mass provisioning using GDMS/TR069 or AES encrypted XML configuration file.
<b>Power &amp; Green Energy Efficiency</b>	Universal power adapter included: Input: 100-240V ; Output: +12V, 1A ; Integrated Power-over-Ethernet (802.3af) Max power consumption 9.5W (power adapter) or 10.8W (PoE)
<b>Temperature and Humidity</b>	Operation: 0°C to 40°C Storage: -10°C to 60°C Humidity: 10% to 90% Non-condensing
<b>Package Content</b>	GRP2624 phone, handset with cord, phone stand, 12V power adapter, network cable, Quick Installation Guide, GP license
<b>Compliance</b>	FCC: FCC Part 15B, Class B; FCC Part 15 Subpart C; FCC Part 15 Subpart E; FCC Part 68 HAC. CE: EN 55032; EN 55035; EN 61000-3-2; EN 61000-3-3; EN 62368-1; EN 301 489-1/-17; EN 300 328; EN 301 893; EN 62311; RCM: AS/NZS CISPR 32; AS/NZS 60950.1; AS/NZS 4268; AS/CA S004.

*GRP2624 Technical specifications*

<b>Protocols/Standards</b>	SIP RFC3261, TCP/IP/UDP, RTP/RTCP, HTTP/HTTPS, ARP, ICMP, DNS(A record, SRV, NAPTR), DHCP, PPPoE, TELNET, TFTP, NTP, STUN, SIMPLE, LLDP, LDAP, TR-069, 802.1x, TLS, SRTP, IPV6
<b>Network Interfaces</b>	Dual switched auto-sensing 10/100/1000 Mbps Gigabit Ethernet ports with integrated PoE
<b>Graphic Display</b>	2.8 inch (320x240) TFT color LCD
<b>Bluetooth</b>	Yes, integrated
<b>Wi-Fi</b>	Yes, integrated dual-band Wi-Fi 802.11 a/b/g/n/ac (2.4Ghz & 5Ghz)
<b>Feature Keys</b>	8 line keys with up to 6 SIP accounts and up to 4 SIP accounts for legacy hardware (discontinued in 2020), 10 MPF extension keys with paper slot, 4 XML programmable context-sensitive softkeys, 5 navigation/menu keys, 9 dedicated function keys for MESSAGE(with LED indicator), TRANSFER, HEADSET, MUTE, SEND/REDIAL, SPEAKERPHONE, VOL+, VOL
<b>Voice Codec</b>	Support for G7.29A/B, G.711μ/a-law, G.726, G.722(wide-band), G723, iLBC, OPUS,in-band and out-of-band DTMF(in audio, RFC2833, SIP INFO)

<b>Auxiliary Ports</b>	RJ9 headset jack allowing EHS with Plantronics headsets, USB to support Grandstream's GUV Series headsets, an other USB headsets
<b>Telephony Features</b>	Hold, transfer, forward, 5-way conference, call park, call pickup, shared-call appearance(SCA)/bridged-line-appearance(BLA), downloadable phonebook(XML, LDAP, up to 2000 items), call waiting, call log(up to 2000 records), XML customization of the screen, off-hook auto dial, auto answer, click-to-dial, flexible dial plan, hot-desking, personalized music ringtones and music on hold, server redundancy and fail-over
<b>HD audio</b>	Yes, HD handset and speakerphone with support for wideband audio. Dual Microphone.
<b>Extension Module</b>	No
<b>Base Stand</b>	Yes, 2 angle positions available, Wall Mountable (Wall Mount *sold separately)
<b>QoS</b>	Layer 2 QoS (802.1Q, 802.1P) and Layer 3 (ToS, DiffServ, MPLS) QoS
<b>Security</b>	User and administrator-level passwords, MD5 and MD5-sess-based authentication, 256-bit AES encrypted configuration file, SRTP, TLS, 802.1x media access control, secure boot.
<b>Multi-language</b>	<b>LCD Language:</b> English 简体中文 (Simplified Chinese) العربية (Arabic) Català (Catalan) Čeština (Czech) Deutsch (German) Ελληνικά (Greek) Español (Spanish) Français (French) עברית (Hebrew) Hrvatski (Croatian) Magyar (Hungarian) Italiano (Italian) 日本語 (Japanese) 한국어 (Korean) Latviešu valoda (Latvian) Nederlands (Dutch) Polski (Polish) Português (Portuguese) Русский (Russian) Svenska (Swedish) Slovenščina (Slovenian) Slovenčina (Slovak) Türkçe (Turkish) Українська (Ukrainian) 正體中文 (Traditional Chinese) <b>WebUI Language:</b> English 简体中文 (Simplified Chinese) العربية (Arabic) Čeština (Czech) Deutsch (German) Español (Spanish) Français (French) עברית (Hebrew) Hrvatski (Croatian) Magyar (Hungarian) Italiano (Italian) 日本語 (Japanese) 한국어 (Korean) Nederlands (Dutch) Polski (Polish) Português (Portuguese) Русский (Russian) Slovenščina (Slovenian) Türkçe (Turkish) 繁體中文 (Traditional Chinese)
<b>Upgrade/Provisioning</b>	Firmware upgrade via FTP/TFTP / HTTP / HTTPS, mass provisioning using GDMS/TR069 or AES encrypted XML configuration file.
<b>Power &amp; Green Energy Efficiency</b>	Universal power adapter included: Input:100-240V ; Output: +12V, 1A ; Integrated Power-over-Ethernet (802.3af) Max power consumption 9.5W (power adapter) or 10.8W (PoE)
<b>Temperature and Humidity</b>	Operation: 0°C to 40°C Storage: -10°C to 60°C Humidity: 10% to 90% non-condensing
<b>Package Content</b>	GRP2634 phone, handset with cord, phone stand, 12V power adapter, network cable, Quick Installation Guide, GP license
<b>Physical</b>	Dimension: 220mmx 210mmx 82mm Unit Weight: 880g ; Package Weight:1260g
<b>Compliance</b>	FCC: Part 15 (CFR 47) Class B CE: EN55022 Class B; EN55024 Class B; EN61000-3-2; EN61000-3-3; EN60950-1 RCM: AS/ACIF S004; AS/NZS CISPR22/24; AS/NZS 60950.1

*GRP2634 Technical specifications*

<b>Protocols/Standards</b>	SIP RFC3261, TCP/IP/UDP, RTP/RTCP, HTTP/HTTPS, ARP, ICMP, DNS(A record, SRV,NAPTR), DHCP, PPPoE, TELNET, TFTP, NTP, STUN, SIMPLE, LLDP, LDAP, TR-069, 802.1x, TLS, SRTP, IPV6
<b>Network Interfaces</b>	Dual switched auto-sensing 10/100/1000 Mbps Gigabit Ethernet ports with integrated PoE



<b>Graphic Display</b>	4.3inch(480x272) TFT color LCD
<b>Bluetooth</b>	Yes, integrated
<b>Wi-Fi</b>	Yes, integrated dual-band Wi-Fi 802.11 a/b/g/n/ac (2.4Ghz & 5Ghz)
<b>Feature Keys</b>	12 line keys with up to 6 SIP accounts, 24MPK extension keys with paper slot, 5 XML programmable context-sensitive softkeys, 5 navigation/menu keys, 8 dedicated function keys for: MESSAGE(with LED indicator), TRANSFER, HEADSET, HOLD,MUTE, SEND/REDIAL, SPEAKERPHONE, VOL+, VOL-
<b>Voice Codec</b>	Support for G7.29A/B, G.711μ/a-law, G.726, G.722(wide-band), G723, iLBC, OPUS, inband and out-of-band DTMF(in audio, RFC2833, SIP INFO)
<b>Auxiliary Ports</b>	RJ9 headset jack allowing EHS with Plantronics headsets, USB to support Grandstream's GUV Series headsets and other USB headsets
<b>Telephony Features</b>	Hold, transfer, forward, 5-way conference, call park, call pickup, shared-call appearances(SCA)/bridged-line-appearance(BLA), downloadable phonebook(XML, LDAP, up to 2000 items), call waiting, call log(up to 2000 records), XML customization of the screen, off-hook auto dial, auto answer, click-to-dial, flexible dial plan, hot-desking, personalized music ringtones and music on hold, server redundancy, and fail-over
<b>HD audio</b>	Yes, HD handset and speakerphone with support for wideband audio. Dual Microphone.
<b>Extension Module</b>	Yes
<b>Base Stand</b>	Yes, 2 angle positions available, Wall Mountable (Wall Mount *sold separately)
<b>QoS</b>	Layer 2 QoS (802.1Q, 802.1P) and Layer 3 (ToS, DiffServ, MPLS) QoS
<b>Security</b>	User and administrator-level passwords, MD5 and MD5-sess-based authentication, 256-bit AES encrypted configuration file, SRTP, TLS, 802.1x media access control, secure boot.
<b>Multi-language</b>	<b>LCD Language:</b> English 简体中文 (Simplified Chinese) العربية (Arabic) Català (Catalan) Čeština (Czech) Deutsch (German) Ελληνικά (Greek) Español (Spanish) Français (French) עברית (Hebrew) Hrvatski (Croatian) Magyar (Hungarian) Italiano (Italian) 日本語 (Japanese) 한국어 (Korean) Latviešu valoda (Latvian) Nederlands (Dutch) Polski (Polish) Português (Portuguese) Русский (Russian) Svenska (Swedish) Slovenščina (Slovenian) Slovenčina (Slovak) Türkçe (Turkish) Українська (Ukrainian) 正體中文 (Traditional Chinese) <b>WebUI Language:</b> English 简体中文 (Simplified Chinese) العربية (Arabic) Čeština (Czech) Deutsch (German) Español (Spanish) Français (French) עברית (Hebrew) Hrvatski (Croatian) Magyar (Hungarian) Italiano (Italian) 日本語 (Japanese) 한국어 (Korean) Nederlands (Dutch) Polski (Polish) Português (Portuguese) Русский (Russian) Slovenščina (Slovenian) Türkçe (Turkish) 繁體中文 (Traditional Chinese)
<b>Upgrade/Provisioning</b>	Firmware upgrade via FTP/TFTP/FTPS/HTTP/HTTPS, mass provisioning using GDMS/TR-069 or AES encrypted XML configuration file.
<b>Power &amp; Green Energy Efficiency</b>	Universal power adapter included: Input:100-240V ; Output: +12V, 1A ; Integrated Power-over-Ethernet(802.3af) Max power consumption 3.2W(power adapter) or 4.3W(PoE)
<b>Temperature and Humidity</b>	Operation: 0°C to 40°C Storage: -10°C to 60°C Humidity: 10% to 90% non-condensing
<b>Package Content</b>	GRP2636 phone, handset with cord, phone stand, 12V power adapter, network cable, Quick Installation Guide, GPL license

<b>Physical</b>	Dimension: 220mmx 210mmx 82mm Unit Weight: 880g ; Package Weight:1260g
<b>Compliance</b>	FCC: FCC Part 15 Class B; FCC Part 15 Subpart C,15.247; FCC Part 15 Subpart E,15.407; FCC Part 68 HAC. CE: ETSI EN 301 893; ETSI EN 301 489-1/-17; ETSI EN 300 328; EN IEC 62311; EN 55032; EN 55035; EN 62368-1. IC: RSS-247 Issue 2; RSS-Gen Issue 5; ICES-003 Issue 7; CS-03, Part V. RCM: AS/NZS CISPR32; AS/NZS 4268; AS/NZS 2772.2; AS/NZS 62368.1; AS/CA S004. UKCA: ETSI EN 301 893; ETSI EN 301 489-1/-17; ETSI EN 300 328; BS EN IEC 62311; BS EN 55032; BS EN 55035; BS EN 62368-1.

*GRP2636 Technical specifications*

<b>Protocols/Standards</b>	SIP RFC3261, TCP/IP/UDP, RTP/RTCP/RTCP-XR, HTTP/HTTPS, ARP, ICMP, DNS (A record, SRV, NAPTR), DHCP, PPPoE, SSH, TFTP, FTP/FTPS, NTP, STUN, SIMPLE, LLDP, LDAP, TR-069, 802.1x, TLS, SRTP, IPv6
<b>Network Interfaces</b>	Dual switched auto-sensing 10/100/1000 Mbps Ethernet ports with integrated PoE
<b>Graphic Display</b>	7" (1042x600) capacitive touch TFT color LCD
<b>Bluetooth</b>	Yes, integrated
<b>Wi-Fi</b>	Yes, integrated dual-band Wi-Fi 802.11 a/b/g/n/ac (2.4Ghz & 5Ghz)
<b>Feature Keys</b>	5 navigation/menu keys, 9 dedicated function keys for MESSAGE (with LED indicator), TRANSFER, HOLD, HEADSET, MUTE, SEND/REDIAL, SPEAKERPHONE, VOL+, VOL-
<b>Voice Codec</b>	Support for G.729A/B, G.711μ/a-law, G.726, G.722 (wide-band), OPUS, iLBC and in-band and out-of-band DTMF (in audio, RFC2833, SIP INFO)
<b>Auxiliary Ports</b>	RJ9 headset jack allowing EHS with Plantronics headsets, USB port
<b>Telephony Features</b>	Hold, transfer, forward, 5-way conference, call park, call pickup, shared-call appearance (SCA) / bridged line appearance (BLA), downloadable phonebook (XML, LDAP, up to 2000 items), call waiting, call log(up to 2000 records), XML customization of screen, off-hook auto dial, auto answer, click-to-dial, flexible dial plan, hot-desking, personalized music ringtones and music on hold, server redundancy and fail-over
<b>HD audio</b>	Yes, HD handset and speakerphone with support for wideband audio, and dual microphone.
<b>Extension Module</b>	Yes
<b>Base Stand</b>	Yes, 2 angle positions available, Wall Mountable (Wall Mount *sold separately)
<b>QoS</b>	Layer 2 QoS (802.1Q, 802.1P) and Layer 3 (ToS, DiffServ, MPLS) QoS
<b>Security</b>	User and administrator level passwords, MD5 and MD5-sess based authentication, 256-bit AES encrypted configuration file, SRTP, TLS, 802.1x media access control, secure boot.
<b>Multi-language</b>	<b>LCD Language:</b> English 简体中文 (Simplified Chinese) العربية (Arabic) Català (Catalan) Čeština (Czech) Deutsch (German) Ελληνικά (Greek) Español (Spanish) Français (French) עברית (Hebrew) Hrvatski (Croatian) Magyar (Hungarian) Italiano (Italian) 日本語 (Japanese) 한국어 (Korean) Latviešu valoda (Latvian) Nederlands (Dutch) Polski (Polish) Português (Portuguese) Русский (Russian) Svenska (Swedish) Slovenščina (Slovenian) Slovenčina (Slovak) Türkçe (Turkish) Українська (Ukrainian) 正體中文 (Traditional Chinese) <b>WebUI Language:</b> English 简体中文 (Simplified Chinese) العربية (Arabic) Čeština (Czech) Deutsch (German) Español (Spanish) Français (French) עברית (Hebrew) Hrvatski (Croatian) Magyar (Hungarian) Italiano (Italian) 日本語 (Japanese) 한국어 (Korean) Nederlands (Dutch) Polski (Polish) Português (Portuguese) Русский (Russian) Slovenščina (Slovenian) Türkçe (Turkish) 繁體中文 (Traditional Chinese)
<b>Upgrade/Provisioning</b>	Firmware upgrade via TFTP/HTTP/HTTPS/FTP/FTPS, mass provisioning using GDMS/TR-069, or AES encrypted

	XML configuration file.
<b>Power &amp; Green Energy Efficiency</b>	Universal power adapter included: Input: 100-240V. Output: +12V, 1A. Integrated Power-over-Ethernet (802.3af) Max power consumption 6.5W (power adapter)
<b>Temperature and Humidity</b>	Operation: 0°C to 40°C Storage: -10°C to 60°C Humidity: 10% to 90% non-condensing
<b>Package Content</b>	GRP2670 phone, handset with cord, phone stand, 12V power adapter, network cable, Quick Installation Guide
<b>Compliance</b>	FCC: Part 15 Subpart B(Class B), Part 15 Subpart C 15.247, Part 15 Subpart C 15.407, Part 1 Subpart I, Part 68.316/317. IC: RSS-247, RSS-Gen, RSS-102, ICES-003, CS-03 Part V; CE: EN 55032, EN 55035, EN 61000-3-2, EN 61000-3-3, EN 62368-1, EN 62311, EN 301 489-1, EN 301 489-17, EN 300 328, EN 301 893; RCM: AS/NZS CISPR 32, AS/NZS 62368.1, AS/NZS 4268, AS NZS 2772.2, AS/CA S004.

*GRP2670 Technical specifications*

<b>Protocols/Standards</b>	SIP RFC3261, TCP/IP/UDP, RTP/RTCP, HTTP/HTTPS, ARP, ICMP, DNS(A record, SRV, NAPTR), DHCP, PPPoE, SSH, TFTP, NTP, STUN, SIMPLE, LLDP, LDAP, TR-069, 802.1x, TLS, SRTP, IPV6
<b>Network Interfaces</b>	Dual switched auto-sensing 10/100/1000 Mbps Gigabit Ethernet ports with integrated PoE
<b>Graphic Display</b>	5.0 inch (1280x720) TFT color LCD
<b>Wi-Fi</b>	Yes, integrated dual-band WiFi 802.11 a/b/g/n/ac (2.4Ghz & 5Ghz)
<b>Bluetooth</b>	Yes, integrated
<b>Feature Keys</b>	14 line keys with up to 6 SIP accounts, 6 XML programmable context-sensitive softkeys, 5 navigation/menu keys, dedicated function keys for: MESSAGE (with LED indicator), TRANSFER, HOLD, HEADSET, MUTE, SEND/REDIAL, SPEAKERPHONE, VOL+, VOL-
<b>Voice Codec</b>	Support for G.729A/B, G.711μ/a-law, G.726-32, G.722(wide-band), G723.1, iLBC, OPUS, in-band and out-of-band DTMF(in audio, RFC2833, SIP INFO)
<b>Auxiliary Ports</b>	RJ9 headset jack (allowing EHS with Plantronics headsets), USB
<b>Telephony Features</b>	Hold, transfer, forward, 5-way conference, call park, call pickup, shared-callappearance (SCA)/bridged-line-appearance (BLA), downloadable phonebook(XML, LDAP, up to 2000 items), call waiting, call log(up to 2000 records), XML customization of screen, off-hook auto dial, auto answer, click-to-dial, flexible dial plan, hot-desking, personalized music ringtones and music on hold, server redundancy and fail-over
<b>HD audio</b>	Yes, HD handset and speakerphone with support for wideband audio, and dual microphone
<b>Extension Module</b>	Yes, GBX20
<b>Base Stand</b>	Yes, allow 2 angle positions
<b>Wall Mountable</b>	Yes, (*wall mount sold separately)
<b>QoS</b>	Layer 2 QoS (802.1Q, 802.1P) and Layer 3 (ToS, DiffServ, MPLS) QoS

<b>Security</b>	User and administrator level passwords, MD5 and MD5-session based authentication, 256-bit AES encrypted configuration file, SRTP, TLS, 802.1x media access control, secure boot
<b>Multi-language</b>	<p><b>LCD Language:</b> English 简体中文 (Simplified Chinese) العربية (Arabic) Català (Catalan) Čeština (Czech) Deutsch (German) Ελληνικά (Greek) Español (Spanish) Français (French) עברית (Hebrew) Hrvatski (Croatian) Magyar (Hungarian) Italiano (Italian) 日本語 (Japanese) 한국어 (Korean) Latviešu valoda (Latvian) Nederlands (Dutch) Polski (Polish) Português (Portuguese) Русский (Russian) Svenska (Swedish) Slovenščina (Slovenian) Slovenčina (Slovak) Türkçe (Turkish) Українська (Ukrainian) 正體中文 (Traditional Chinese)</p> <p><b>WebUI Language:</b> English 简体中文 (Simplified Chinese) العربية (Arabic) Čeština (Czech) Deutsch (German) Español (Spanish) Français (French) עברית (Hebrew) Hrvatski (Croatian) Magyar (Hungarian) Italiano (Italian) 日本語 (Japanese) 한국어 (Korean) Nederlands (Dutch) Polski (Polish) Português (Portuguese) Русский (Russian) Slovenščina (Slovenian) Türkçe (Turkish) 繁體中文 (Traditional Chinese)</p>
<b>Upgrade/Provisioning</b>	Firmware upgrade via FTP/TFTP / HTTP / HTTPS, mass provisioning using GDMS/TR069 or AES encrypted XML configuration file
<b>Power &amp; Green Energy Efficiency</b>	<p>Universal power adapter included:  Input:100-240V ; Output: +12V, 1.0A ;  Integrated Power-over-Ethernet(802.3af)  Max power consumption 6.2W(power adapter)</p>
<b>Physical</b>	<p>Unit weight:1050g ; Package weight:1620g  Dimension: 263mm x 210mm x 82mm</p>
<b>Temperature and Humidity</b>	<p>Operation: 0°C to 40°C  Storage: -10°C to 60°C  Humidity: 10% to 90% Non-condensing</p>
<b>Package Content</b>	GRP2650 phone, handset with cord, phone stand, 12V power adapter, network cable, Quick Installation Guide
<b>Compliance</b>	<p>FCC: Part 15 (CFR 47) Class B  CE: EN55022 Class B; EN55024 Class B;EN61000-3-2; EN61000-3-3;EN60950-1  RCM: AS/ACIF S004; AS/NZS CISPR22/24; AS/NZS 60950.1</p>

GRP2650 Technical specifications

## GETTING STARTED

This chapter provides basic installation instructions including the list of the packaging contents and also information for obtaining the best performance with the GRP261X/GRP2624/GRP2634/GRP2636/GRP2670/GRP2650 phone.

### Equipment Packaging

GRP261x/GRP2624/GRP263x/GRP2670/GRP2650
<ul style="list-style-type: none"> <li>• 1 x GRP261x/GRP2624/GRP263x/GRP2670/GRP2650 Main Case.</li> <li>• 1 x Handset.</li> <li>• 1 x Phone Stand.</li> <li>• 1 x Ethernet Cable.</li> <li>• 1 x Power Adapter.</li> <li>• 1 x Phone cord.</li> <li>• 1 x Quick Installation Guide.</li> </ul>

Equipment Packaging

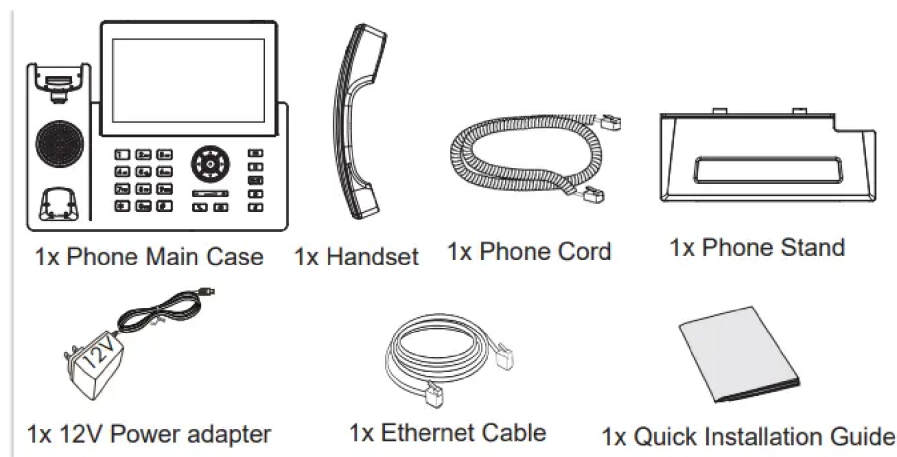

*GRP261X/GRP2624/GRP2634/GRP2636/GRP2670/GRP2650 Package Content (GRP2670 as an example)*

**Note**

Check the package before installation. If you find anything missing, contact your system administrator.

**Connecting and Setting Up the GRP261X/GRP2624/GRP2634/GRP2636/GRP2670/GRP2650**

The GRP261X/GRP2624/GRP2634/GRP2636/GRP2670/GRP2650 phones can be installed on the desktop using the phone stand or attached to the wall using the slots for wall mounting.

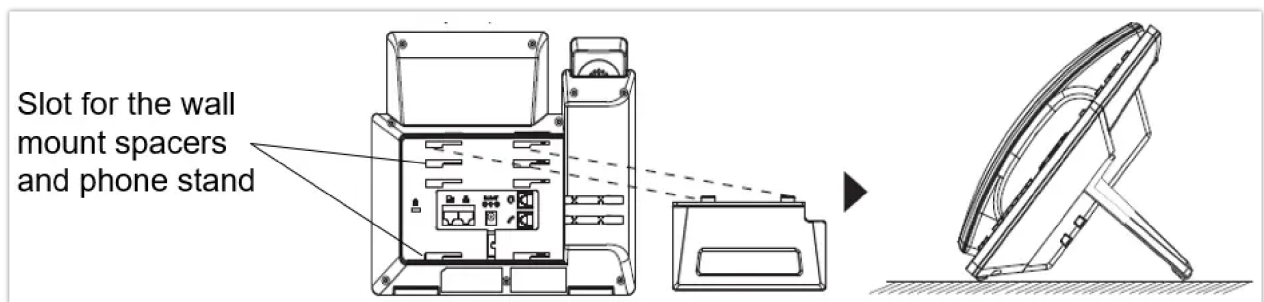

*Phone Stand and Mounting Slots on the GRP261X/GRP2624/GRP2634/GRP2636/GRP2670/GRP2650*

**Using the Phone Stand**

To install the phone on the table with the phone stand, attach the phone stand to the bottom of the phone through the phone stand slot. (Upper half, bottom part).

**Using the Slots for Wall Mounting**

1. Attach the wall mount spacers to the slot for wall mount spacers on the back of the phone.
2. Attach the phone to the wall via the wall mount hole.
3. Pull out the tab from the handset cradle (See figure below).
4. Rotate the tab and plug it back into the slot with the extension up to hold the handset while the phone is mounted on the wall (see figure below).

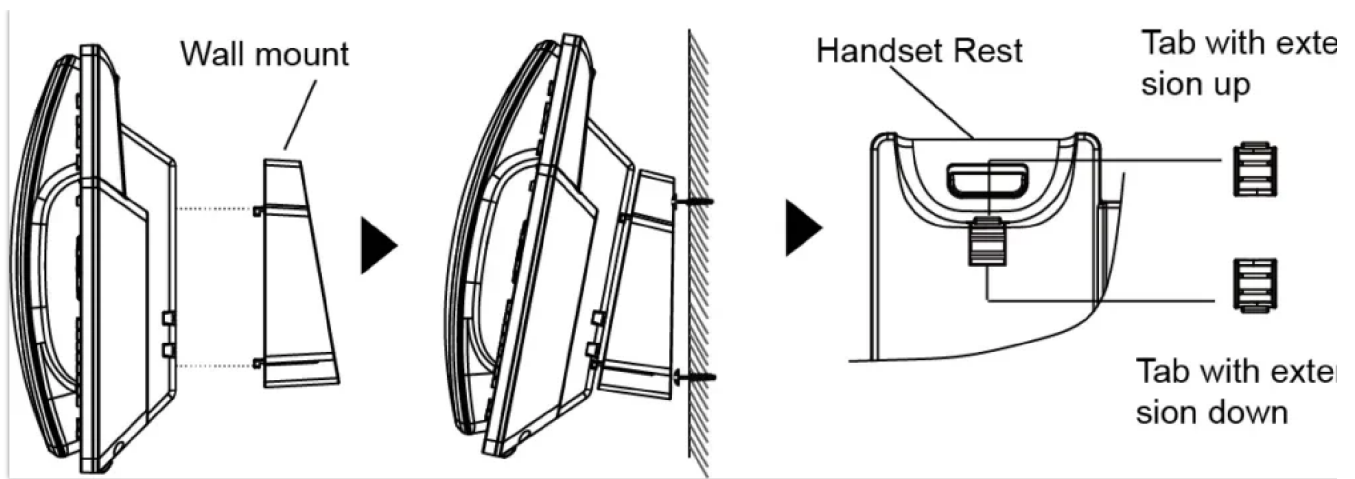

Tab on the Handset Cradle

## Connecting the GRP261X/GRP2624/GRP2634/GRP2636/GRP2670/GRP2650

To set up the GRP261X/GRP2624/GRP2634/GRP2636/GRP2670/GRP2650, follow the steps below:

1. Connect the handset and main phone case with the phone cord.
2. Connect the LAN port of the phone to the RJ-45 socket of a hub/switch or a router (LAN side of the router) using the Ethernet cable.
3. Connect the PSU output plug to the power jack on the phone; plug the power adapter into an electrical outlet. If a PoE switch is used in step 2, this step could be skipped.
4. The LCD will display provisioning or firmware upgrade information. Before continuing, please wait for the date/time display to show up.
5. Using the phone embedded web server or keypad configuration menu, you can further configure the phone using either a static IP or DHCP.

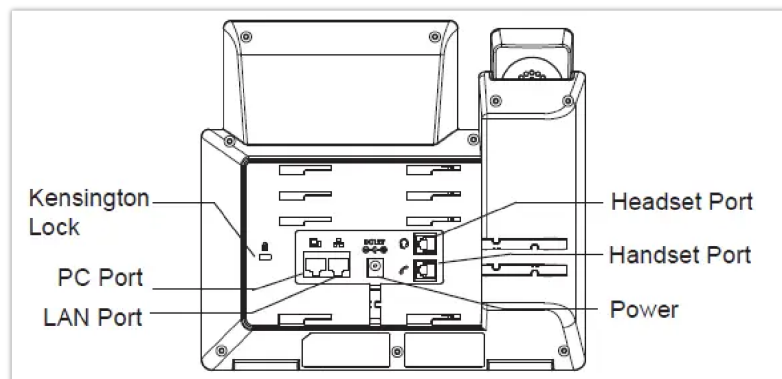

GRP261X/GRP2624/GRP2634/GRP2636/GRP2650/GRP2670 Back View

## GETTING TO KNOW GRP261X/GRP2624/GRP2634/GRP2636/GRP2650/GRP2670

### Idle Screen

GRP261X/GRP2624/GRP2634/GRP2636/GRP2650/GRP2670 screen displays differently depending on whether the phone is idle or in use (active). The following figures show the idle screen of GRP2612/GRP2612P/GRP2612W/GRP2612G/GRP2613/GRP2614/GRP2615/GRP2616/GRP2624/GRP2634/GRP2636/GRP2650/GRP2670.



















GRP261X/GRP2624/GRP2634/GRP2636/GRP2650/GRP2670  
Idle Screen

<b>Date and Time</b>	Displays the current date and time. It can be synchronized with Internet time servers.
<b>Network icon</b>	Shows the status of network. It will indicate whether the network is down or starting.
<b>Status icon</b>	Shows the status of the phone for registration status, call features etc., using icons as shown in the next table.
<b>Line status indicator</b>	Displays the name of the account that is in use.
<b>Softkeys in idle screen</b>	<p>The softkeys are context sensitive and will change depending on the status of the phone. Default functions assigned to softkeys are:</p> <ul style="list-style-type: none"> <li>• <b>SwitchSCR/NEXTSCR:</b> Toggles between different idle screens: Press the most left softkey (or RIGHT/LEFT arrow buttons) to switch screens.</li> <li>• <b>ForwardAll:</b> Unconditionally forwards the phone line (account 1) to another phone.</li> <li>• <b>MissedCalls:</b> Shows up unanswered calls to this phone.</li> <li>• <b>Redial:</b> Redials the last dialed number</li> </ul>
<b>Softkeys in call screen</b>	<p>The softkeys are context sensitive and will change depending on the call status of the phone. Here are the main softkeys in call screen.</p> <ul style="list-style-type: none"> <li>• <b>Redial:</b> Redials the last dialed number after off hook when there is existed call log.</li> <li>• <b>Dial:</b> Dials the call out after off hook and entering the number.</li> <li>• <b>Answer Call:</b> Answers the incoming call when the phone is ringing.</li> <li>• <b>Reject Call:</b> Rejects the incoming call when the phone is ringing.</li> <li>• <b>End Call:</b> Ends the active call.</li> <li>• <b>Transfer:</b> Transfer softkey will show up after pressing TRAN button and entering transfer target number. Press Transfer softkey to do blind transfer.</li> <li>• <b>Split:</b> In attended transfer mode, after establishing the second call, press on Switch softkey to switch between the two calls.</li> <li>• <b>ConfCall:</b> Conference the active calls</li> <li>• <b>ReConf:</b> Re-establish the conference among the calls on hold.</li> </ul>

#### LCD Display Definitions

The following table describes the items displayed on the GRP261X/GRP2624/GRP2634/GRP2636/GRP2670/GRP2650 idle screen:

	<p><b>Network Status.</b> OFF - Network connection is up ON - Network connection is down</p>
	<p><b>DND Status.</b> OFF - Do Not Disturb disabled ON - Do Not Disturb enabled</p>
	<p><b>Call Forward All Status.</b> OFF - Call Forward All feature disabled ON - Call Forward All feature enabled</p>
	<p><b>Call Forward Busy Status.</b></p>

	<p>OFF - Call Forward Busy feature disabled ON - Call Forward Busy feature enabled</p>
	<p><b>Call Forward No Answer Status.</b> OFF - Call Forward No Answer feature disabled ON - Call Forward No Answer feature enabled</p>
	<p><b>Call Forward Busy and Call Forward No Answer Status.</b> OFF - Call Forward All and Call Forward No Answer feature disabled ON - Call Forward All and Call Forward No Answer feature enabled</p>
	<p><b>Missed Call Status.</b> OFF - No missed call ON - New missed call</p>
	<p><b>Handset Status.</b> OFF - Handset is not in use ON - Handset is in use</p>
	<p><b>Headset Status.</b> OFF - Headset is not in use ON - Headset is in use</p>
	<p><b>Microphone MUTE Status.</b> OFF - No muted ON - Muted</p>
	<p><b>Bluetooth Status.</b> (GRP2614/GRP2615/GRP2616/GRP2624/GRP2634/GRP2636/GRP2670/GRP2650 only) OFF - Bluetooth icon disappears ON - Bluetooth icon appears Paired – Bluetooth icon turns bright</p>
	<p><b>Incoming Call.</b> The current call is an incoming call</p>
	<p><b>Outgoing Call.</b> The current call is an outgoing call</p>
	<p><b>Call On Hold.</b> OFF - No call on hold ON – Call on hold</p>
	<p><b>Call Connect.</b> OFF - No call ON - Call connected</p>
	<p><b>IP Call Status</b> The current call is an IP call.</p>
	<p><b>SIP Call</b> Enter number for initiate call. The current call is a SIP call.</p>
	<p><b>Ringtone Volume</b> Call screen icon.</p>
	<p><b>Ringtone Volume mute</b> Call screen icon. The volume of ringtone is mute</p>
	<p><b>Energy Saving Mode</b> Shown on the top of the LCD screen if power saving mode is enabled</p>



## Using the Keypad

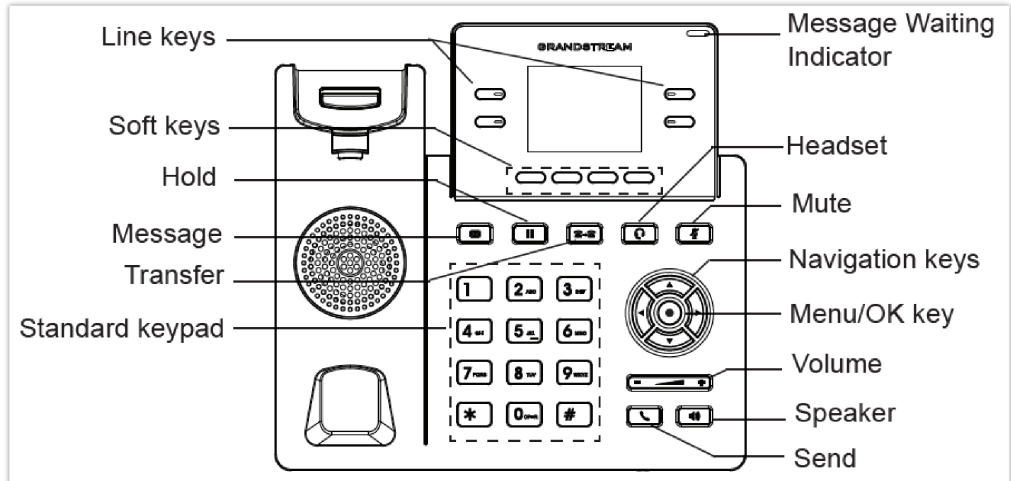

GRP2612/GRP2612P/GRP2612W/GRP2612G Keyboard

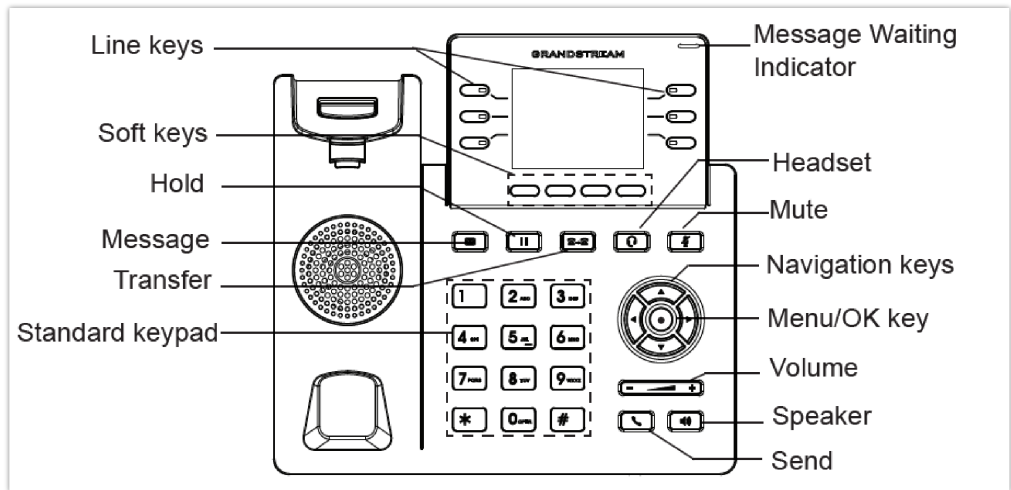

GRP2613 Keyboard

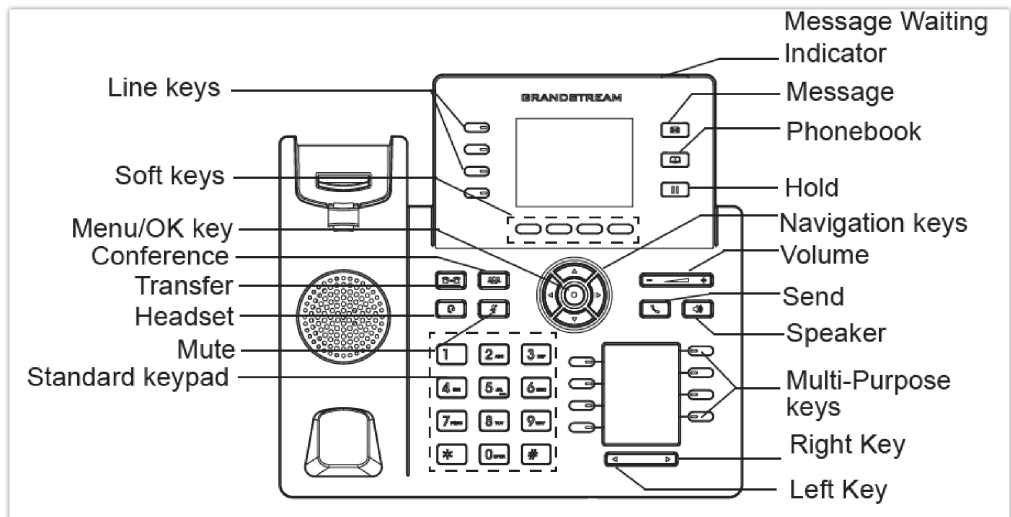

GRP2614 Keyboard

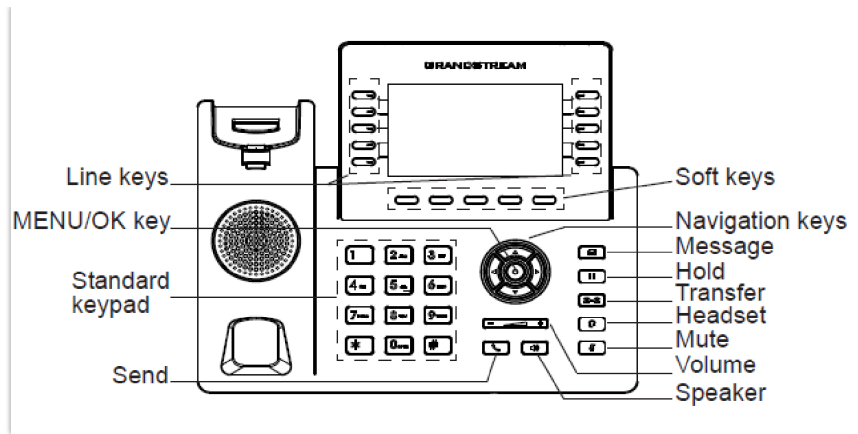

GRP2615 Keyboard

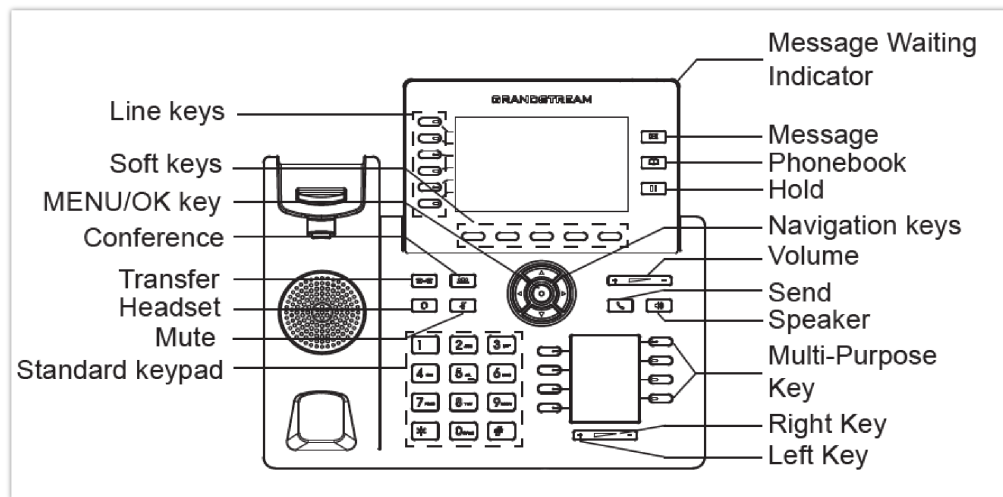

GRP2616 Keyboard

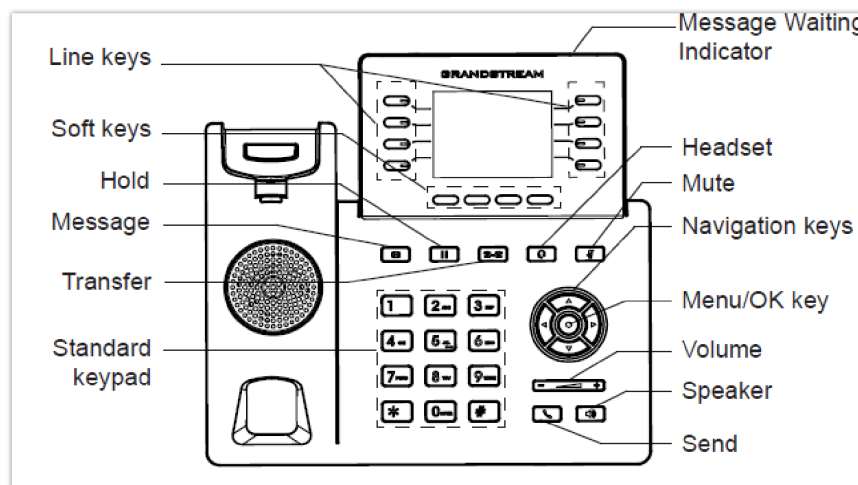

GRP2624 Keyboard

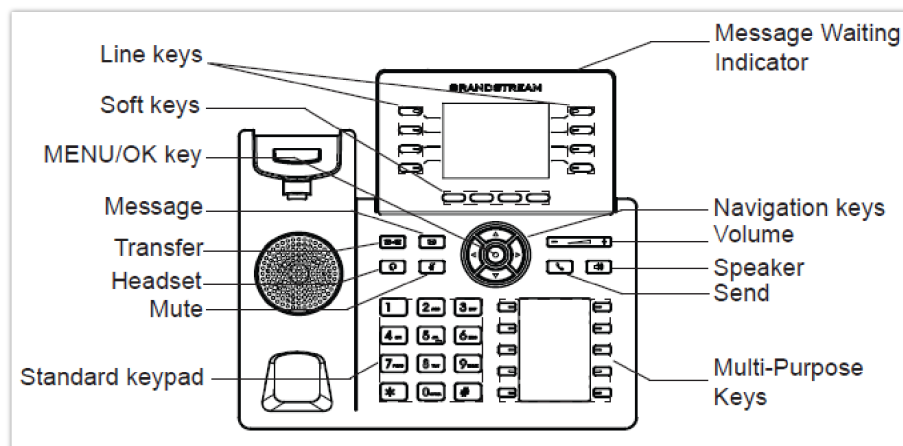

GRP2634 Keyboard

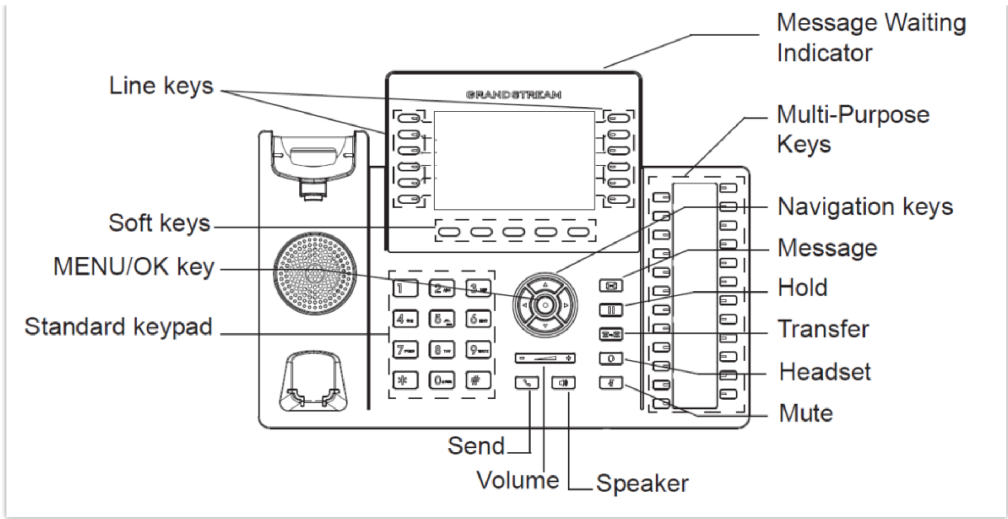

GRP2636 Keyboard

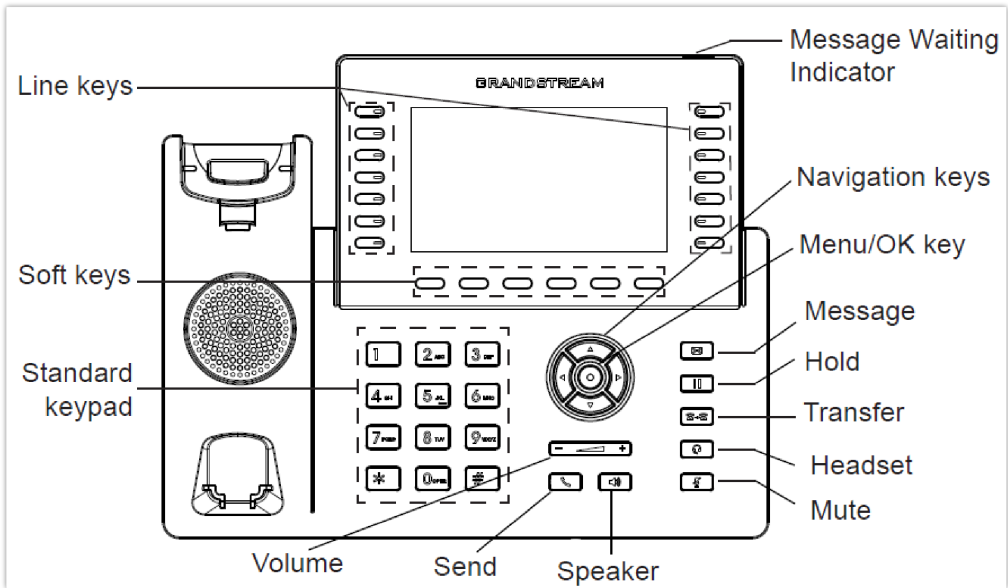



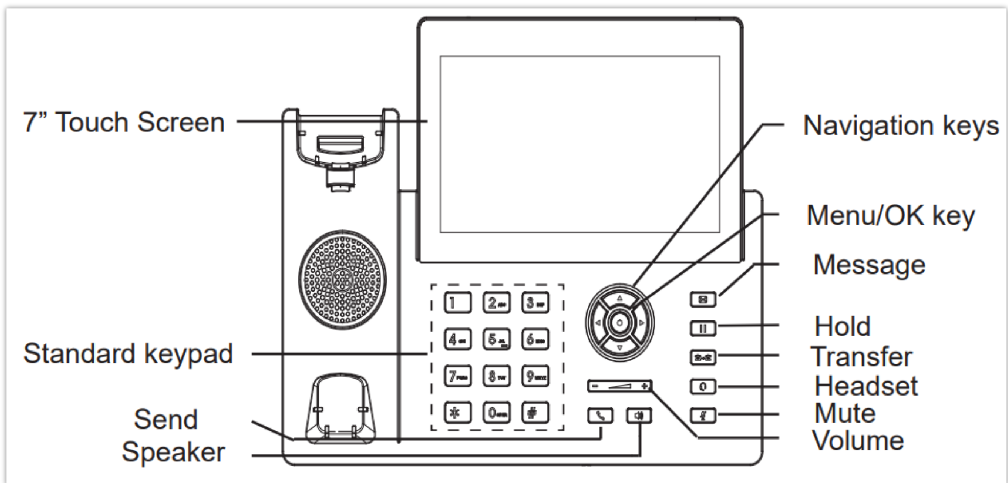





GRP2650 Keyboard



GRP2670 Keyboard

	<p><b>Contacts:</b> Press to view and edit contact information.</p>
	<p><b>Hold:</b> Press to put call on hold or resume the call.</p>
	<p><b>Mute:</b> During a call, Press Mute button to mute or unmute the call.</p>

	<b>Headset:</b> Press to switch to headset mode
	<b>Message:</b> Press to view voicemail messages.
	<b>Transfer:</b> Press to transfer an active call to another number.
	<b>Conference:</b> Press to conference call.
	<b>Speaker:</b> Press to switch between speaker and handset mode in an active call.
	<b>Send/Redial</b>
	<b>Volume:</b> Adjust volume.
	<b>Up Navigation key:</b> In idle screen, press for 3 seconds to see the IP.
	<b>MENU Button</b>

GRP261X/GRP2624/GRP2634/GRP236/GRP2650/GRP2670 Keypad Buttons

## Configuration via Keypad

To configure the LCD menu using the phone's keypad, follow the instructions below:

- **Enter MENU options.** When the phone is idle, press the round MENU button to enter the configuration menu.
- Navigate to the menu options. Press the arrow keys up/down/left/right to navigate to the menu options.
- Enter/Confirm selection. Press the round MENU button or "Select" Softkey to enter the selected option.
- Exit. Press "Exit" Softkey to exit the previous menu.
- **Return to Home page.**

In the Main menu, press Home Softkey to return home screen.

In sub-menu, press and hold "Exit" Softkey until Exit Softkey changes to Home Softkey, then release the Softkey.

- The phone automatically exits MENU mode with an incoming call, when the phone is off-hook or the MENU mode if left idle for more than 60 seconds.
- When the phone is idle, press and hold the UP-navigation key for 3 seconds to see the phone's IP address, IP setting, MAC address, and software address.

The MENU options are listed in the following table.

<b>Call History</b>	Displays Local call logs: All Calls/Answered Calls/Dialed Calls/Missed Calls/Transferred Calls.
<b>Status</b>	Displays account status, network status, software version number and Hardware <ul style="list-style-type: none"> <li>● <b>Account status</b></li> </ul>

	<ul style="list-style-type: none"> <li>● <b>Network status:</b> Press to enter the sub menu for MAC address, IP setting information (DHCP/Static IP/PPPoE). Ipv4 address, Ipv6 address, Subnet Mask, Gateway and DNS server.</li> <li>● <b>System Information:</b> Press to enter the sub menu for Hardware version, P/N number. Boot, Core, Base, Prog version and IP Geographic Information.</li> <li>● <b>Provider Status:</b> Press to enter the sub menu for Hardware version, P/N number. Boot, Core, Base, Prog version and IP Geographic Information.</li> </ul>
<b>Contacts</b>	<p><b>Contacts</b> sub menu includes the following options:</p> <ul style="list-style-type: none"> <li>● <b>Local Phonebook</b></li> <li>● <b>Local Group</b></li> <li>● <b>LDAP Directory</b></li> </ul> <p>Contacts sub menu is for Local Phonebook, Local Group, LDAP Directory and Broadsoft Phonebooks. User could configure phonebooks/groups/LDAP options here, download phonebook XML to the phone and search phonebook/LDAP directory.</p>
<b>Messages</b>	<p>Message sub menu include the following options:</p> <ul style="list-style-type: none"> <li>– <b>Instant Message:</b> Displays received instant messages</li> <li>– <b>Voice Mails:</b> Displays voicemail message information in the format below: new messages/all messages (urgent messages/all urgent messages).</li> </ul>
<b>Preference</b>	<p><b>Preference</b> sub menu includes the following options:</p> <ul style="list-style-type: none"> <li>– <b>Do Not Disturb:</b> Enables/disables Do Not Disturb on the phone.</li> <li>– <b>Keypad Lock:</b> Turns on/off keypad lock feature and configures keypad lock password. The default keypad lock password is null. If user enabled Star Key lock without configuring password, user can unlock keypad by holding * key 4 seconds and pressing “OK” button.</li> <li>– <b>Sounds:</b> <ul style="list-style-type: none"> <li>● <b>Ring Tone:</b> Configures different ring tones for incoming call.</li> <li>● <b>Ring Volume:</b> Adjusts ring volume by pressing left/right arrow key</li> </ul> </li> <li>– <b>Appearance:</b> <ul style="list-style-type: none"> <li>● <b>Active LCD Brightness:</b> Adjusts active LCD brightness by pressing left/right arrow key.</li> <li>● <b>Idle LCD Brightness:</b> Adjusts idle LCD brightness by pressing left/right arrow key.</li> <li>● <b>Active LCD Timeout:</b> Adjusts the minute of active backlight timeout.</li> <li>● <b>Screensaver:</b> Enables/Disables Screensaver.</li> <li>● <b>Screensaver Timeout:</b> Configures the minutes of idle before the screensaver activates. Valid range is 3 to 60.</li> </ul> </li> <li>– <b>MPK LCD Settings (Available on GRP2614/GRP2616 only):</b> <ul style="list-style-type: none"> <li>● <b>MPK LCD Display Order:</b> Choose MPK LCD Display Order whether to be Sequential or Alternating</li> <li>● <b>Display Contact on MPK LCD:</b> Enable / Disable Display Contact on MPK Order</li> </ul> </li> <li>– <b>Language and Input:</b> <ul style="list-style-type: none"> <li>● <b>Display Language:</b> Selects the language to be displayed on the phone’s LCD. Users could select Automatic for local language based on IP location if available. By default, it is Auto.</li> <li>● <b>Default Input Selection:</b> Selects the Input mode from Multi-Tap and Shiftable. By default, it is Multi-Tap. — <b>Multi-Tap:</b> User may tap the same key multiple times to switch to the desired character. — <b>Shiftable:</b> After pressing the number button, user will see the IDs of the characters that matching to the button. User can select the desired character by entering the corresponding ID on keypad.</li> </ul> </li> <li>– <b>Date Time:</b> <ul style="list-style-type: none"> <li>● Allow DHCP Option 42 to override NTP server</li> <li>● Allow DHCP Option 2 to override NTP server</li> <li>● Time Settings</li> </ul> <p>It is used to configure date and time on the phone.</p> </li> <li>– <b>Search Mode:</b> <p>Specifies the phonebook search mode to <b>QuickMatch</b> or <b>ExactMatch</b>. By default, it is <b>QuickMatch</b>.</p> </li> </ul>
<b>Phone</b>	<p><b>Phone</b> sub menu includes the following options:</p> <ul style="list-style-type: none"> <li>● <b>SIP:</b> Configures SIP Proxy, Outbound Proxy, SIP User ID, SIP Auth ID, SIP Password, SIP Transport and Audic information to register SIP account on the phone.</li> <li>● <b>Call Features:</b> Configures call forward features for Forward All, Forward Busy, Forward No Answer and No Answer Timeout.</li> </ul>

## System

System sub menu includes the following options:

### – Network:

- **Internet Protocol** :Selects Prefer IPv4 / Prefer IPv6 / IPv4 only or IPv6 only. The default setting is “Prefer IPv4”.
- **IP Setting**: Selects IP mode (DHCP/Static IP/PPPoE); Configures PPPoE account ID and password; Configures static IP address, Netmask, Gateway, DNS Server 1 and DNS Server 2.
- **802.1X**: Enables/Disables 802.1X mode; Configures 802.1x identity and MD5 password.
- **Layer 2 QoS**: Configures 802.1Q/VLAN Tag and priority value. Select “Reset VLAN Config” to reset VLAN configuration.

### – Wi-Fi Settings (GRP2612W, GRP2614, GRP2615, GRP2616, GRP2624, GRP2634, GRP2636, GRP2670 & GRP2650 only):

- **Enables/disables Wi-Fi**: Enables/disables Wi-Fi
- **Scan**: Enables/disables Wi-Fi

### – Bluetooth Settings (GRP2614/GRP2615, GRP2616, GRP2624, GRP2634, GRP2636, GRP2670 & GRP2650 only):

- **Bluetooth Status**: Displays the status of Bluetooth
- **Bluetooth MAC**: Displays the GRP phone’s Bluetooth MAC address.  
3. (Bluetooth MAC address is GRP phone’s MAC address plus 1)
- **Power**: Turns on/off the Bluetooth feature.
- **Handsfree Mode**: Enables/Disables Handsfree mode
- **Bluetooth Name**: Specifies GRP phone name when discovered by other Bluetooth devices.
- **Start Scan**: Starts to scan other Bluetooth devices around the phone. If found, user could press “Pair” Softkey, and enter Pin code to pair to other Bluetooth devices.

### – Web Access:

- Web Access Mode
- HTTP web port
- HTTPs web port

### – Upgrade:

- **Firmware Server**: Configures firmware server for upgrading the phone.
- **Config Server**: Configures config server for provisioning the phone.
- **Upgrade Via**: Specifies upgrade/provisioning via TFTP/FTP/FTPS/HTTP/HTTPS.
- **Start Provision**: Starts Provision immediately.

### – Language Download:

- **Auto Language Download**
- **Language Download**

### – Factory Functions:

- **Diagnostic Mode**: All LEDs will light up. All keys’ name will display in red on LCD screen before diagnosing. Press any key on the keypad to diagnose the key’s function. When done, the key’s name will display in blue on LCD. Lift and put back the handset to exit diagnostic mode.
- **Audio Loopback**: Speak to the phone using speaker/handset/headset. If you can hear your voice, your audio is working fine. Press “Exit” Softkey to exit audio loopback mode.
- **LCD on/off**: Selects this option to turn off LCD. Press any button to turn on LCD.
- **LCD Diagnostic**: Selects this option to turn off LCD. Press any button to turn on LCD.
- **Certificate Verification**: This is used to validate certificate chain for the server’s certificate.

### – UCM Detect:

Detect/connect UCM server to process auto-provision. Manually input the IP and port of the UCM server phone wants to bind with; Or select from the available UCM server in network.

### – Authentication:

- **Admin Password**: This is used to change the admin password for Web UI access.
- **End User Password**: This is used to change end user password for Web UI access.
- **Settings**: Turns on/off Test Password Strength feature. This will allow only passwords with some constraints to ensure better security.

### – Operation:

- **Factory Reset**: It is used to restore the phone to factory default settings.
- **Ping and Traceroute**: It is used to show the route taken by packets across to an URL.
- **Alternative firmware**: It is used to show current and alternative firmware versions available on the phone. Users can “rollback” to alternative firmware from this menu.

Reboot	Reboots the phone.
--------	--------------------

Configuration Menu

The following picture shows the keypad MENU configuration flow:

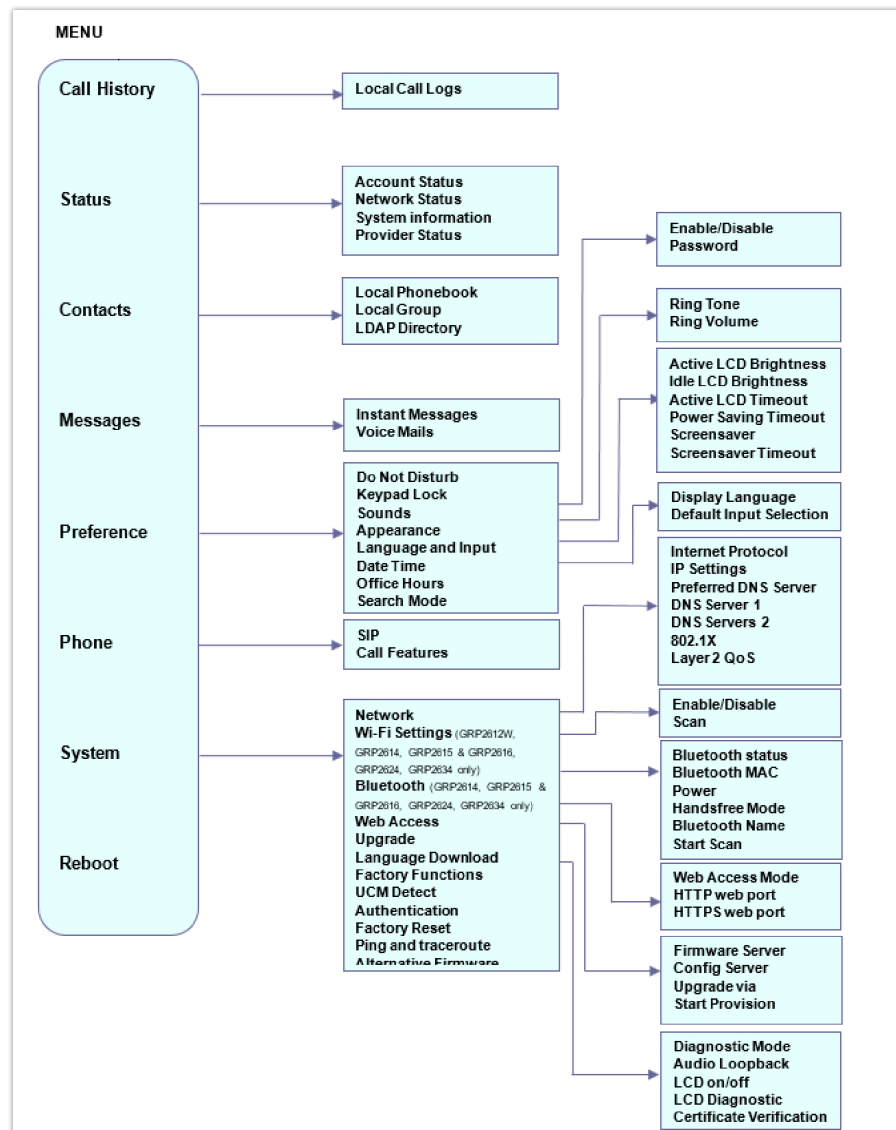

GRP261x Menu

### Characters Input

The GRP261x/GRP2624/GRP263x/GRP2670/GRP2650 keypad can be used by tapping on an input field.

GRP261x/GRP2624/GRP263x/GRP2670/GRP2650 keypad has 4 modes "123", "ABC", "abc" and "1Bc". The default mode is "1Bc".

**Note**

If the input field is accepting only digits, only "123" mode will be available.

- o **"123" Mode:** This mode allows to enter digits and . only.
- o **"ABC" Mode:** This mode allows to enter capital letters, digits, and symbolic characters.
- o **"abc" Mode:** This mode allows to enter small letters, digits, and symbolic characters.
- o **"1Bc" Mode:** This mode allows to enter capital letters, small letters, digits, and symbolic characters.

The following table describes the allowed characters for each key.

Key	Description	Key	Description	Key	Description
-----	-------------	-----	-------------	-----	-------------

1	1 Space . : / ' ` @ * + - = ,   & ? ! % ( ) ~ _ < > { } [ ] ^	2	2 ABC a b c	3	3 DEF d e f
4	4 GHI g h i	5	5 JKL j k l	6	6 MNO m n o
7	7 PQRS p q r s	8	8 TUV t u v	9	9 WXYZ w x y z
*	*	0	0	#	#

## MPK LCD

### Information:

MPK LCD is available on GRP2614 & GRP2616 only.

The GRP2614/GRP2616 supports MPK LCD with 8 physical MPKs and 3 pages, allowing to configure up to 24 fully programmable phone extensions to the phone.

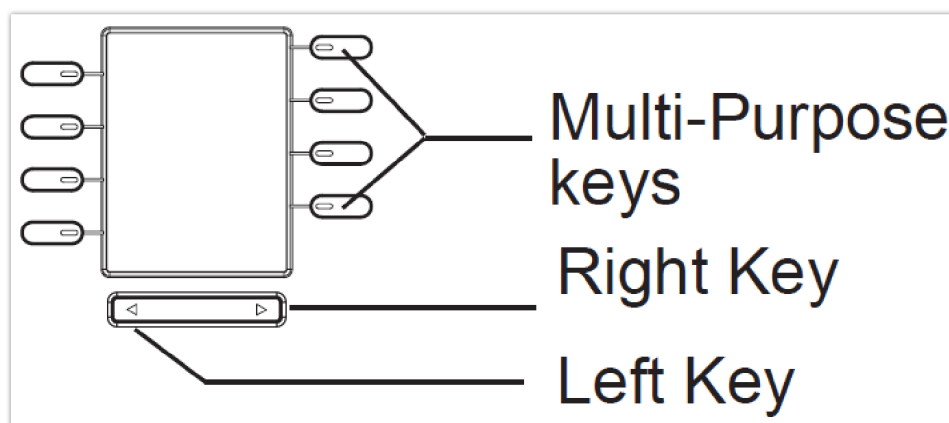

GRP2614 MPK LCD

The MPKs can be configured via:

- o Web GUI **Settings** → **Programmable Keys** → **Physical Multi-Purpose Keys**.
- o Or from the phone directly; by pressing and holding for 5 seconds the MPK button to configure. The phone LCD and MPK LCD will display related settings as shown below:

Phone LCD Configuration (MPK1)

After finishing the configuration, press the Left or Right button at the bottom to browse all the MPK's status on the different pages.

For more information, please refer to the admin guide:



<https://documentation.grandstream.com/knowledge-base/grp261x-grp262x-grp263x-series-administration-guide/>



# TELEPHONY FEATURES

## Make Phone Calls

### Handset, Speaker, and Headset Mode

The GRP261X/GRP2624/GRP263x/GRP2670/GRP2650 allows users to switch between handset, speaker, or headset when making calls. Press the Hook Switch to switch to the handset; press the Headset button  to switch to the headset, or press the Speaker button  to switch to the speaker.

### Multiple SIP Accounts and Lines

GRP2612/GRP2612P/GRP2612W/GRP2612G support up to 4 SIP accounts (and up to 2 accounts for legacy hardware) with 4 line keys; GRP2613 supports up to 4 SIP accounts (and up to 3 accounts for legacy hardware) with 6 line keys and GRP2614 supports up to 4 SIP accounts with 4 line keys. GRP2615 supports up to 5 SIP accounts with 10 line keys. GRP2616 supports up to 6 SIP accounts with 6 line keys, GRP2624/GRP2625 supports up to 6 SIP accounts (and up to 4 accounts for legacy hardware) and 8 lines, GRP2636 supports 6 SIP accounts with 12 lines, GRP2670 supports 6 SIP accounts with 12 lines and GRP2650 supports 6 SIP accounts with 14 lines. Each account is capable of independent SIP server, user, and NAT settings. Each of the line buttons is “virtually” mapped to an individual SIP account. In the off-hook state, select an idle line and the dial tone will be heard.

To make a call, select the line you wish to use. The corresponding LINE LED will light up in green. The user can switch lines before dialing any number by pressing the LINE buttons.

**For example:** If 2 independent accounts are registered on GRP261X/GRP2624/GRP263x/GRP2670/GRP2650, when LINE 1 is pressed, the LINE 1 LED will light up in green. If LINE 2 is pressed, the LINE 2 LED will light up in green and the subsequent call will be made through SIP account 2.

Incoming calls to a specific account will attempt to use its corresponding LINE if it is not in use. When the “virtually” mapped line is in use, the phone will flash the other available LINE in red. A line is ACTIVE when it is in use and the corresponding LED is red.

#### Note

Support added for disabling the feature of selecting an account from LCD.

## Completing Calls

There are several ways to complete a call.

- **On-hook dialing.** Enter the number when the phone is on-hook and then send it out.
  1. When the phone is idle, enter the number to be dialed out;
  2. Take the handset off-hook, or Press the Speaker button, or Press the Headset button with the headset plugged in, or Select an available LINE key.
  3. The call will be dialed out.

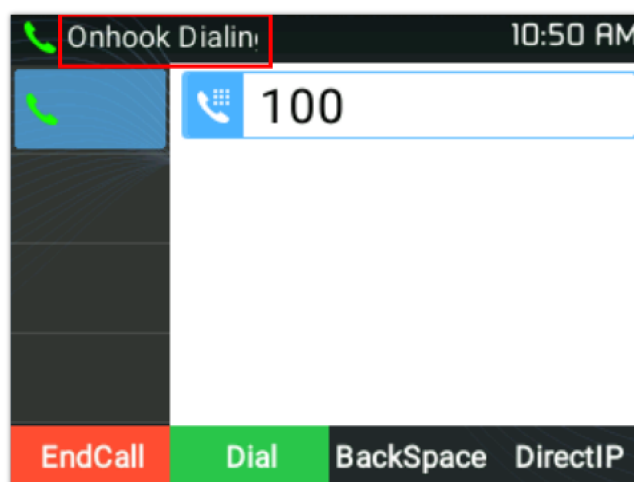

On-hook dialing

- **Off-hook and dial.** Off-hook the phone, enter the number, and send it out.

1. Take handset off-hook; or
  - Press the Speaker button; or
  - Press the Headset button with the headset plugged in; or
  - Press an available LINE key to activate the speaker;
2. You shall hear dial tone after off-hook;
3. Enter the number;
4. Press SEND, \* or # keys to dial out.

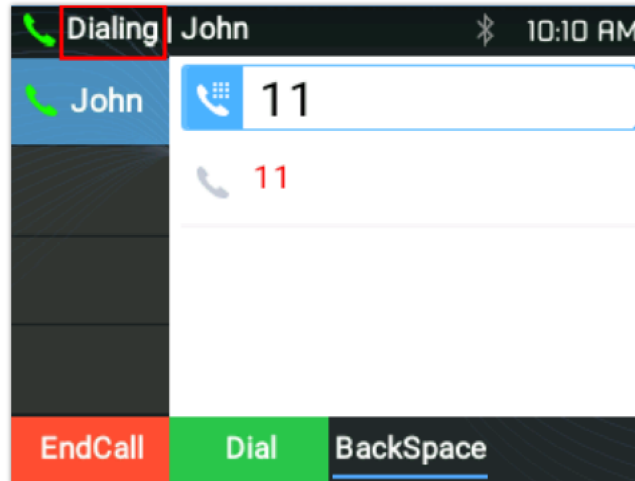

*Off-hook dialing*

- **Predictive dialing.** When dialing numbers, based on the entered digit or digits, the phone will predict and list the candidates of the target number.

If the target number is already saved in the phonebook, when entering the first several digits, the phone will display a list of matching numbers. If the target number appears on the list, the user could select the number using the Up/Down key and dial out. GRP261X/GRP2624/GRP2634 has a predefined call feature code (the first digit is \*). When the user enters \* as the first digit of the target number, the phone will list all the available feature codes.

- **Redial.** Redial the last dialed number.

1. Take handset off-hook; or
  - Press the Speaker button; or
  - Press the Headset button with the headset plugged in; or
  - Press an available LINE key to activate the speaker; or
  - When the phone is in an idle state;
2. Press SEND key or the REDIAL softkey.

- **Via Call History.** Dial the number logged in the phone's call history.

1. Press the MENU button to bring up the main menu then enter Call History; or
2. Press the "History" soft key when the phone is in an idle state;
3. Select the entry you would like to call using the navigation arrow keys;
4. Press SEND button to dial out.

- **Via Phonebook.** Dial the number from the phonebook.

1. Press the MENU button to bring up the main menu then enter Contacts; or  
Press the Contacts button;
2. Enter Local Phonebook/ Broadsoft Phonebook using the navigation arrow keys;
3. Select the contact you would like to call
4. Press SEND button to dial the selected contact.

## Note

Pressing the **MENU** button, users can edit the phone number and choose which account to dial that number by clicking "**Edit / Dial**" soft key.

- **Speed Dial from Line Key.** Dial the number configured as Speed Dial on Line Key.

1. Go to the phone's Web GUI→Settings→Programmable Keys, and configure the Line Key Mode as Speed Dial. Select the account to dial from, and enter the extension number to be dialed out in Value. Click on "Save VPK" at the bottom of the Web GUI page;
2. Off-hook the phone, or directly press the Speed Dial key to dial out.

- **Call Return.** Dial the last answered call.

1. Go to the phone's Web GUI→Settings→Programmable Keys, and configure the Line Mode as Call Return. Select the account to dial from, Value must be set for Call Return;
2. Off-hook the phone, or directly press the Call Return key to dial out.

- **Via Paging/Intercom.**

1. Take handset off-hook; or
  - Press the Speaker button; or
  - Press the Headset button with the headset plugged in; or
  - Press an available LINE key to activate the speaker;
2. You shall hear dial tone after off-hook;
3. Press the MENU button to switch from "**Dialing**" to "**Paging**" (top left of the LCD screen);
4. Enter the number;
5. Press SEND, \* or # keys to dial out.

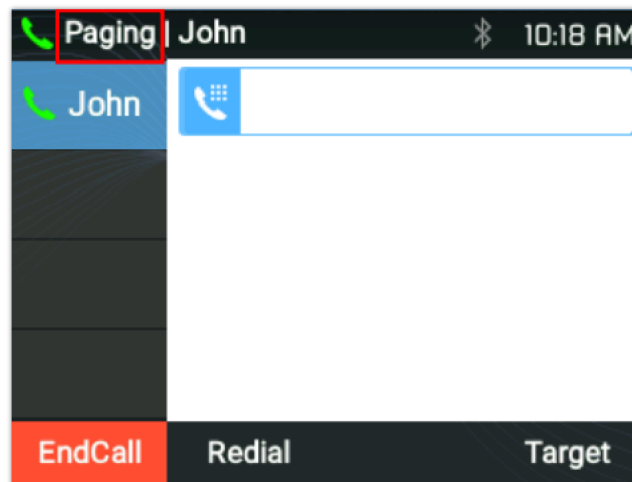

Call using Paging/Intercom

## Notes

- After entering the number, the phone waits for the No Key Entry Timeout (Default timeout is 4 seconds, configurable via Web GUI) before dialing out. Press SEND or # key to override the No Key Entry Timeout;
- If digits have been entered after taking the handset off-hook, the SEND key will work as SEND instead of showing the history of Dialed extensions;
- By default, # can be used as SEND. Users could disable it by setting "User # as Dial Key" to "No" from Web GUI→Account X→Call Settings.
- For Paging/Intercom, if the SIP Server/PBX supports the feature and has the Paging/Intercom feature code set up already, users do not necessarily need to switch to paging mode on the call screen. Simply dial the feature code with extension as a normal call.
- When a call is dialed out via paging, users can see the "call-info" header contains "answer-after=0" and "the "alert-info" header contains "info=alert-autoanswer;delay=0" in the outgoing INVITE.
- During an active call, users can see the call info on LCD:
  - The call lasting time
  - Contact information if the number is already saved in the phonebook.
  - When dialing DTMF, the user can press the round Menu button to switch to the call info page.

- It is possible to mute the call at the dialing stage by composing a number, dialing the call, and pressing the mute button before the call is answered.

## Making Calls Using IP Addresses

Direct IP Call allows two phones to talk to each other in an ad-hoc fashion without a SIP proxy. VoIP calls can be made between two phones if

- Both phones have public IP addresses; or
- Both phones are on the same LAN/VPN using private or public IP addresses; or
- Both phones can be connected through a router using public or private IP addresses (with necessary port forwarding or DMZ).

To make a direct IP call, please follow the steps below:

1. When the phone is at an idle state, press any number key or \* key to bring up "On-hook Dialing" page;
2. Press round MENU key or "DirectIP" softkey
3. Input the target IP address (Please see the example below);
4. Press the "Dial" softkey to dial.

### Note

When completing direct IP call, "Use Random Port" option should be set to "No".

### For example:

If the target IP address is 192.168.1.60 and the port is 5062 (i.e., 192.168.1.60:5062), input the following: 192\*168\*1\*60#5062. The \* key represents the dot (.), and the # key represents the colon (:).

When only dialing the IP address (example: 192\*168\*1\*60) the call will automatically go through the default port 5060.

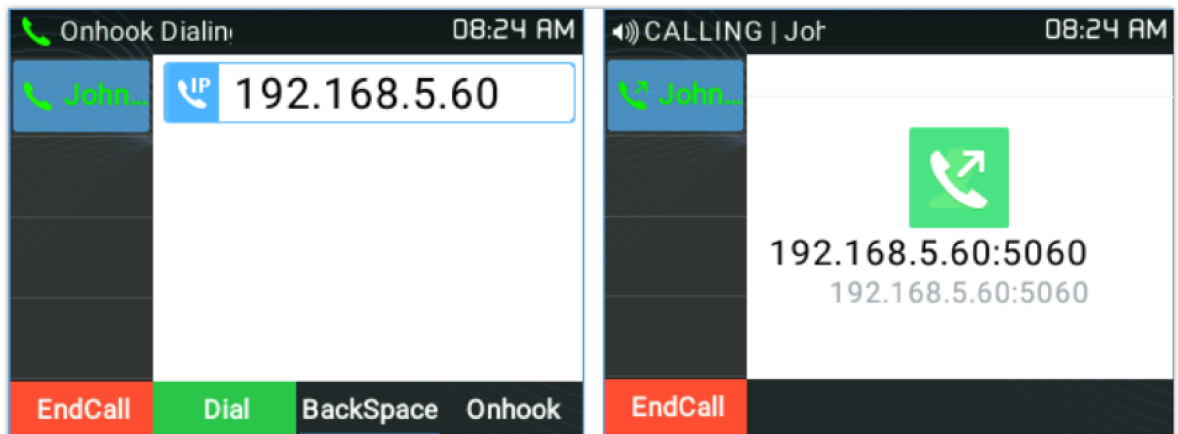

Direct IP Call

## Answering Phone Calls

### Receiving Calls

- **Single incoming call.**

The phone rings with the selected ring tone. The corresponding LINE key will flash in red. Answer call by taking the handset off-hook, or using Speaker/Headset, or pressing the flashing LINE key;

### Note

Users can choose when receiving a call to either ring from their headset, ring from both headset and the speaker, or only ring from the speaker. This option can be enabled from the Web GUI under **Settings → Preferences → Audio Control** and configure "Always Ring Speaker".

- o **Multiple incoming calls.**

When another call comes in while having an active call, the phone will produce a Call Waiting tone (stutter tone). The other LINE key will flash red. Answer the incoming call by pressing the flashing LINE key. The current active call will be put on hold automatically.

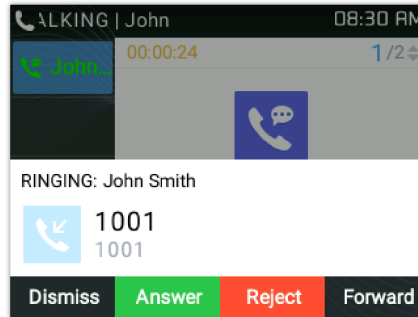

Multiple Incoming Calls

#### Notes

- o When there is an ongoing call, users can disable the incoming call notifications pop up. This way users will not get disrupted by unexpected popup calls but still get notified by the flashing LED. This option can be enabled from the Web GUI under **Settings → Call Features**. For further information, please refer to the admin guide.
- o The user can send DTMF while there is a call waiting on the screen.
- o The user can send out star codes to the SIP Server while being able to use local call features via LCD.

- o **Ring Group Call**

If the phone is a member of a Ring Group when the SIP server receives a call to the Ring Group extension, all the phones will start ringing, on a phone answers the call, a missed call notification will be showing on all the other phones. The GRP261X/GRP2624/GRP263x

/GRP2670/GRP2650 Series support reason header, which allows the phones not to log a missed call if it is answered elsewhere. The following message will be included in the CANCEL SIP message received by phone for notifying it that another user answers the call.

*Reason: SIP; cause=200;text="Call completed elsewhere"*

#### Do Not Disturb

Do Not Disturb can be enabled/disabled from the phone's LCD by following the steps below:

1. Press the Menu button and select "**Preference**" using navigation keys;
2. Press the Menu button again to get into Preference options;
3. When "Do Not Disturb" is highlighted, press the Left/Right key to disable/enable DND;
4. Press the "**Save**" softkey to save the change

Users could also enable/disable DND quickly by pressing the Mute button 

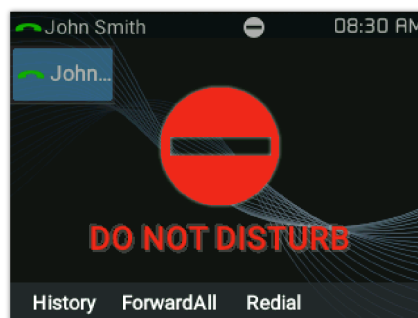

Do Not Disturb

#### Notes

- o The mute button function can be set also to idle Mute, or be disabled under the web GUI option **Settings → Call features → Mute Key Function While Idle**.

- During an active call, press the MUTE button to mute/unmute the microphone. The LCD will show the Mute icon on the top of the screen when the call is muted.

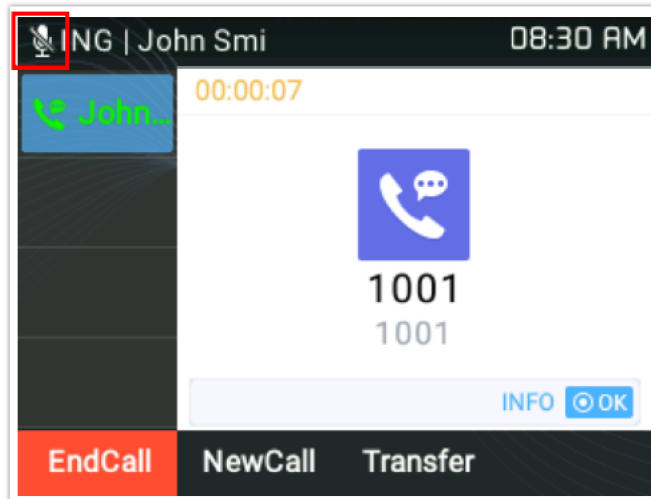

*Call Mute*

- **Block/Allow listing:** If the contact number belongs to the Blocklist group, the call from that number will always be blocked. If the contact number belongs to the Allowlist group, the call will be allowed even in DND mode.

This can be configured from the web GUI, under **"Application → Contacts"** by adding a user into either the "Blocklist" or "whitelist" group as shown below:

*Block/Allow List from Web GUI*

Or from the phone's LCD under **Menu → Contacts → Local Phonebook** as shown below:

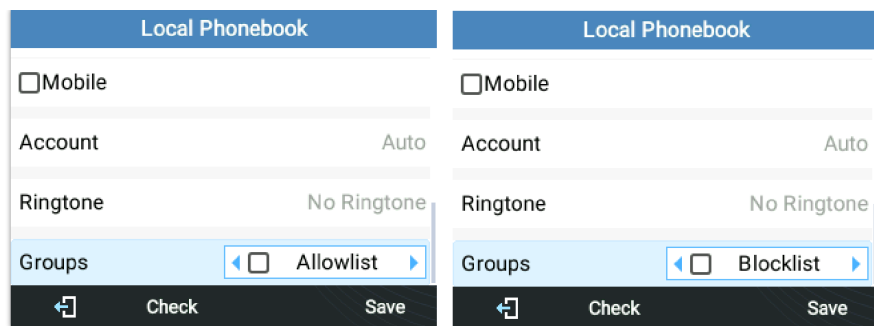

Block/Allow List from LCD

## Call Hold

Place a call on hold by pressing the HOLD button . The active LINE key will blink in green.

### Notes

- If “**On Hold Reminder Tone**” is Enabled under web GUI “**Account X → Call Settings**” then a reminder tone will be played to notify the user that he has a call on hold.
- **Resume.** Resume call by pressing the blinking LINE key.
- **Multiple calls.** Automatically place the active call on hold or switch between calls by pressing the LINE key. Call waiting tone (stutter tone) will be audible on new incoming call during the active call.
- **Call hold duration.** The phone will show the call hold duration as shown in the figure below. The hold duration will be displayed only if there are two calls on hold or more and the user can use the up/down arrows to check the hold duration of each call.
- **End call.** Users can end the call without having to resume it first.

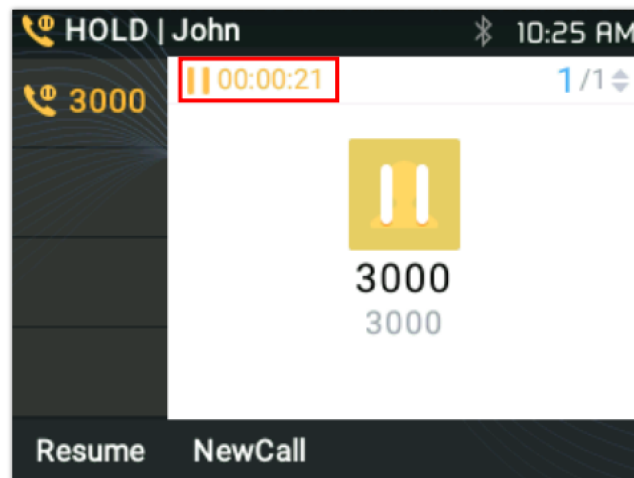

On hold duration

## Call Transfer

GRP261X/GRP2624/GRP263x/GRP2670/GRP2650 series support Blind Transfer and Attended Transfer. This feature can be disabled from the web GUI menu under “**Settings → Call features → Disable Transfer**”.

- **Blind Transfer:**
  1. During the first active call, press TRANSFER and dial the number to transfer to;
  2. Click “Blind Transfer” softkey to complete the transfer of the active call.
- **Attended Transfer:**
  - When set to “**Static**”
    1. During the first active call, open a new LINE  
The first call will be automatically put on hold
    2. Enter the number for the second call in the new line and establish the call;

3. Press TRANSFER;
4. Press the other LINE key, which is on hold to transfer the call.

o When set to **“Dynamic”**

1. During the first active call, press TRANSFER.
2. A new line will be brought up and the first call will be automatically placed on hold;
3. Dial the number and press **“AttTrnf”** soft key to make a second call.
4. Press TRANSFER again. The call will be transferred.



*Dynamic Attended Transfer*

**Note**

When attended transfer is initiated during the transfer process, after dialing out the number for the second call. If the second call is not established yet (ringing), pressing “Cancel” will hang up the second call. If the second call is established (answered), pressing “Split” will resume the second call and keep the first call on hold.

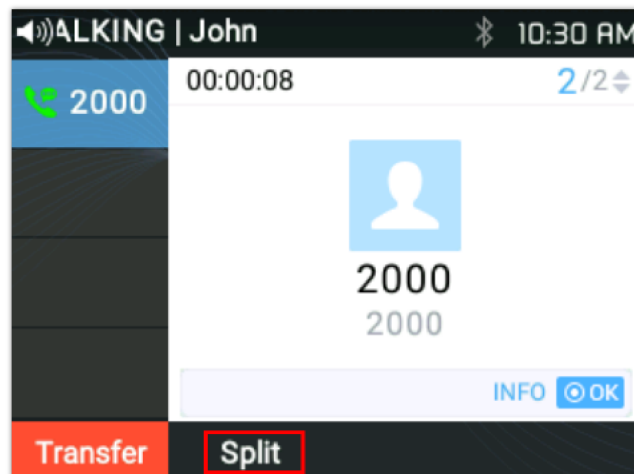

*“Split” softkey*

- o Clicking the Red highlighted **“Transfer”** Key would force a Blind Transfer.

**Target Selection**

Using the target selection feature, users can use the following function:

1. Add a new softkey **“Target”** under the transfer/conference LCD action screen.
2. When clicking on the softkey, it will take the user to a target selection page in which the user can choose other possible transfer/conferer targets (e.g. Local/BS Phonebook, Local/BS Call Logs, LDAP...)
3. When accessing the Local/BS Phonebook and Local/BS Call History page, the softkey will show limited options (e.g. Dial) if the phone is in busy state to make it easier for users to perform the dialing task.



4. When accessing Smart VPK List, the phone will display the list of the VPK targets which are allowed to be used as the transfer/conference target based on the current account.
5. When accessing Line, the phone will list the lines which are available for transfer/conference.

**Example:**

- o Under Transfer screen:

A new softkey **"Target"** is added under the transfer/conference action page.

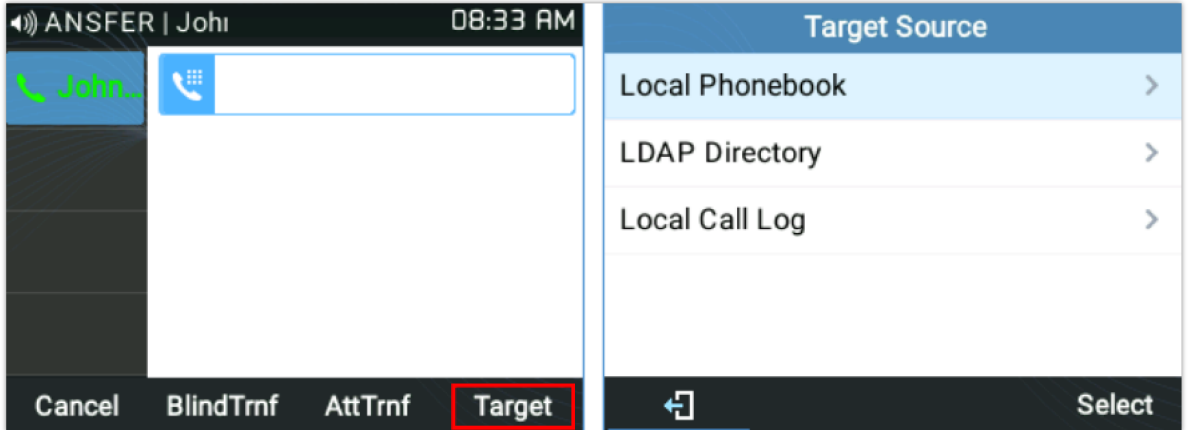

*"Target" softkey under Transfer Action Page*

Users can use navigation keys to select a target from the list and use the Menu button or "Select" softkey to dial out. By selecting Local/Broadsoft Phonebook, Local/Broadsoft Call Log, or LDAP Directory, LCD will display the according screen page with limited options (e.g. Dial) to make it easier for users to perform the dialing task.

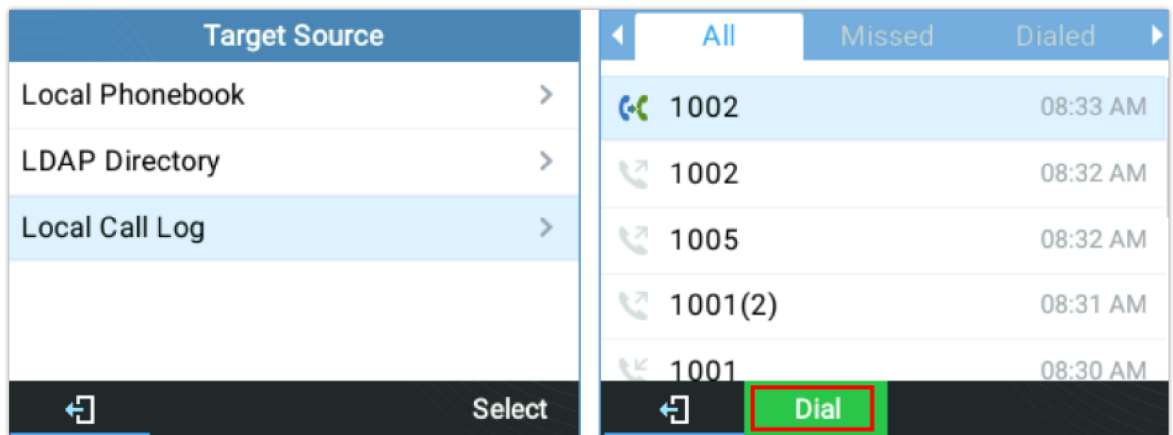

*Target – Local Call Log Page*

**Transfer Information:**

The phone displays Transfer information so users can see who transferred the call...

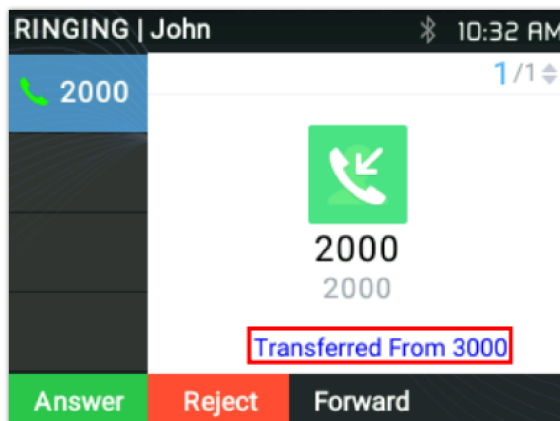

*Transfer from Information While Ringing and During Incoming Call*

## Conference Call

### 5-way conferencing

The GRP26xx series can host a 5-way conference call with other parties (PCMU/PCMA). Users can disable/enable the conference call feature from the phone's web GUI under the menu **Settings → Call features → Disable Conference**.

- **Initiate a conference call:**

1. Establish calls with 1 or 4 parties respectively;
2. While 1 call is active, the other call will be put on hold with its LINE key blinking in green;
3. Press the CONF key;
  - On the **GRP2613**: Click on "ConfCall" SoftKey
4. The conference will be established after pressing the desired LINE key on hold;
  - On the **GRP2613**: Press the "UP arrow" key. Then, click on "ConfCall" SoftKey.

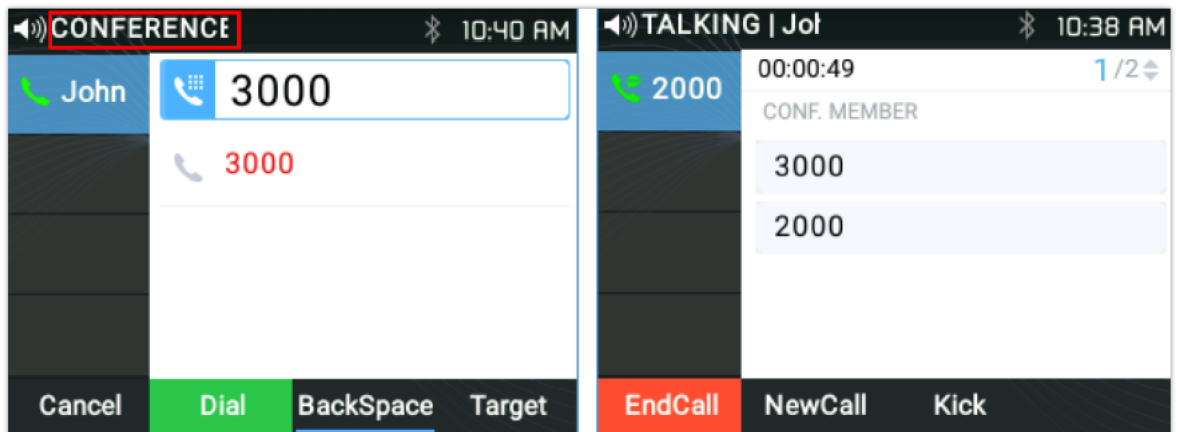

*Established Conference*

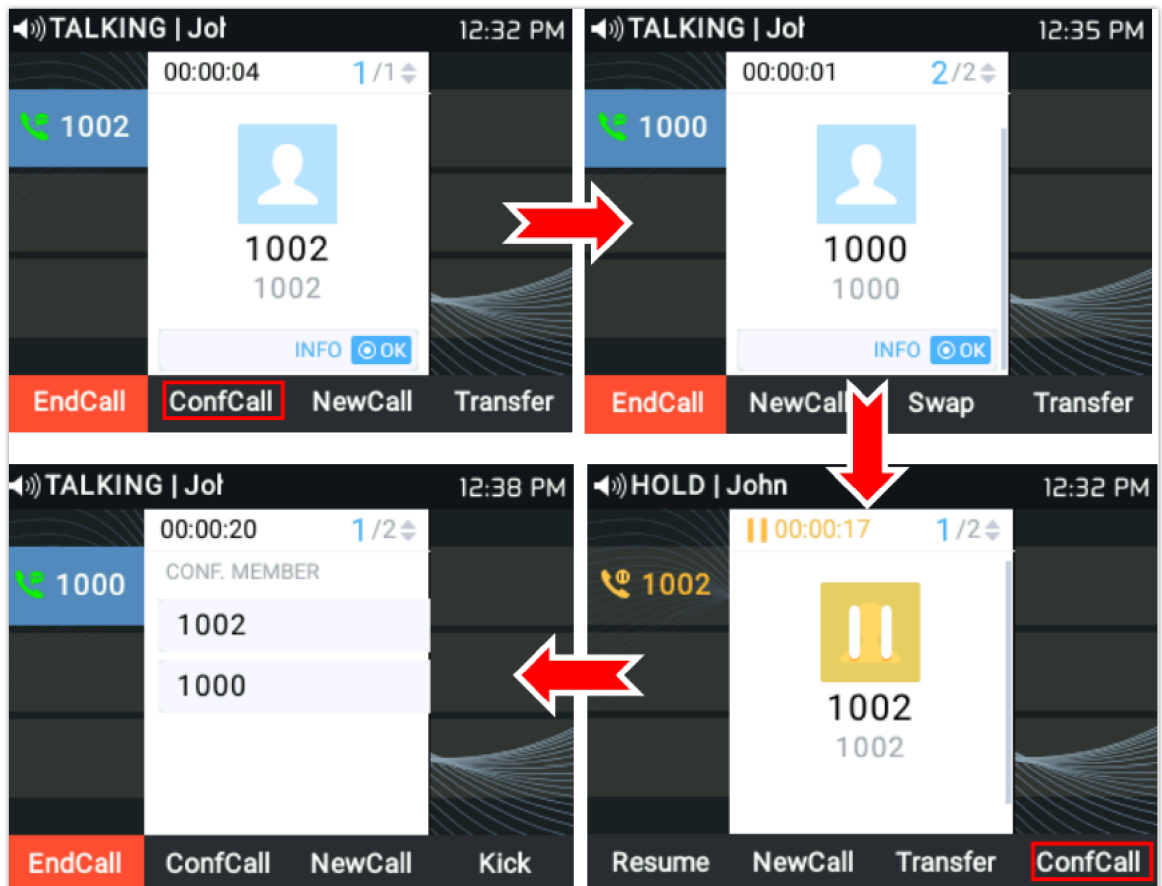

*Establish a Conference Call on the GRP2613*

**Note**

Users may click the "Swap" Softkey to toggle between active calls.

- **Cancel Conference:**

1. If after pressing the CONF key, the user decides to cancel the conference, press the "Cancel" soft key or the current active LINE key (LED is solid green);
2. This will resume the 2-way conversation with the current line.

- **Kick:**

Users can remove an extension from the ongoing conference by pressing the "Kick" soft key, specifying which extension/number to be kicked out then clicking on the "Submit" soft key.

- **Split and Re-conference:**

1. During the conference, press the HOLD key. The conference call will be split, and the calls will be put on hold separately with the LINE key blinking in green;
2. Press a LINE key to resume the 2-way conversation;
3. If users would like to re-establish conference call. Press the "ReConf" softkey right after the conference call is split

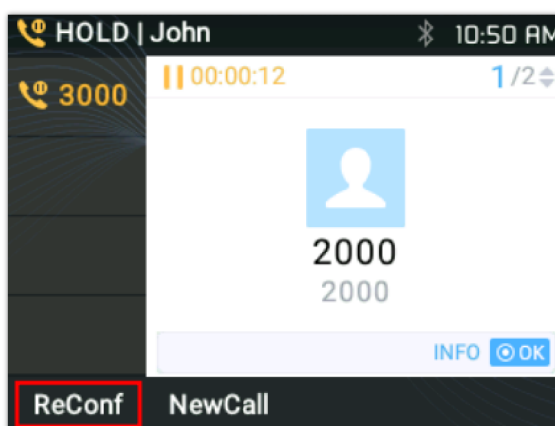

*Split conference*

- **End Conference:**

1. Press the HOLD key to split the conference call. The conference call will be ended with both calls on hold; Or
2. Users could press the "EndCall" softkey or simply hang up to terminate the conference call.

## Easy Conference Mode

GRP2612/GRP2612P/GRP2612W/GRP2612G/GRP2613/GRP2614/GRP2615/GRP2616/GRP2624/GRP2636/GRP2634/GRP2670/GRP2650 support **Easy Conference Mode**, which can be used combined with the traditional way to establish the conference.

- **Initiate a conference call.**

1. Establish 1 call;
2. Press the CONF key and a new line will be brought up using the same account;
3. Dial the number and press SEND key to establish the second call;
4. Press the CONF key or press the "ConfCall" softkey to establish the conference.

- **Split and Re-conference.**

1. During the conference, press the HOLD key. The conference call will be split and both calls will be put on hold separately with 2 LINE keys blinking in green;
2. Press a LINE key to resume the 2-way conversation;
3. If users would like to re-establish a conference call, before 1 separate LINE is selected, press the "ReConf" softkey right after the conference call is split.

- **Cancel Conference.**

1. If the user decides to cancel the conference after establishing the second call, press the “**EndCall**” softkey instead of the “**ConfCall**” softkey/CONF key;
  2. This will end the second call and the screen will show the first call on hold.
- o **End Conference.**
    1. Press the HOLD key to split the conference call. The conference call will be ended with both calls on hold; Or
    2. Users could press the “**EndCall**” softkey or simply hang up to terminate the conference call.

#### Notes

- o The party that starts the conference call must remain in the conference for its entire duration, you can put the party on mute, but it must remain in the conversation. In addition, this is not applicable when the feature “Transfer on Conference Hang-up” is turned on. Under **Web GUI → Accounts → AccountX → Call settings**
- o The option “Disable Conference” must be set to “No” **Web UI → Settings → Call Features** to establish a conference call.
- o Users can limit the ability of the phone to cross conferencing different accounts. This option can be found under device **web UI → Settings → Call Features**.

For more information, please refer to the admin guide.

<https://documentation.grandstream.com/knowledge-base/grp261x-grp262x-grp263x-series-administration-guide/>

## UCM Conference

### Participate in UCM Conference Room

Users could dial the UCM conference room extension to join the conference. If a password is required, enter the password to join the conference either as a normal user or as an administrator.

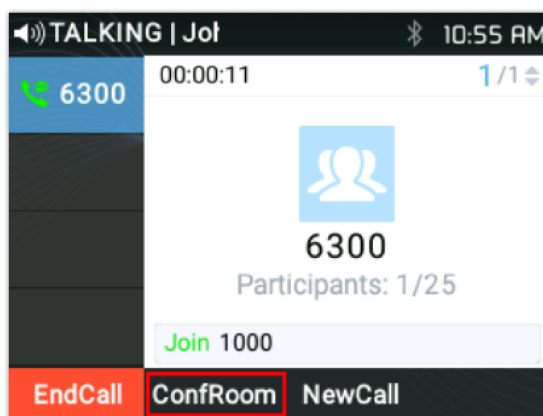

*Join UCM Conference*

- o Follow the Interactive Voice Response (IVR) instructions.

### Conference Call Menu (CCM)

During a UCM conference, only conference Administrators can press on the **ConfRoom** softkey to view/invite members, bridge conference, remove the bridge, mute, unmute and lock the conference.

Conference Room Participants		
1	1000	1000
2	4000	4000
3	3000	3000
5	2000	2000
<div style="display: flex; justify-content: space-between; align-items: center;"> <span>←</span> <span>Invite</span> <span>Bridge</span> <span>...</span> </div>		

*List of Conference Room Users*

## Conference Call Operations

- **Invite User:**

Press the **Invite** softkey, specify the target extension number then click **OK**. The phone will note the operation by displaying [**Join User\_Extension**] on the conference home screen.

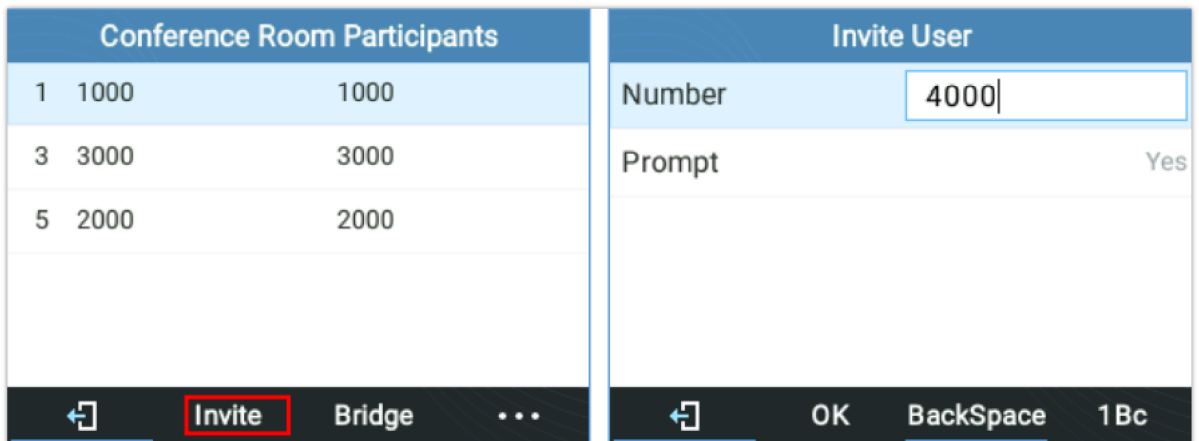

UCM Conference Menu – Invite User

- **Kick User:**

Select the user's extension then press **Kick**. The phone will note the operation by displaying [**Exit User\_Extension**] on the conference home screen. Then the user won't be available on the Conference Room Participants List.

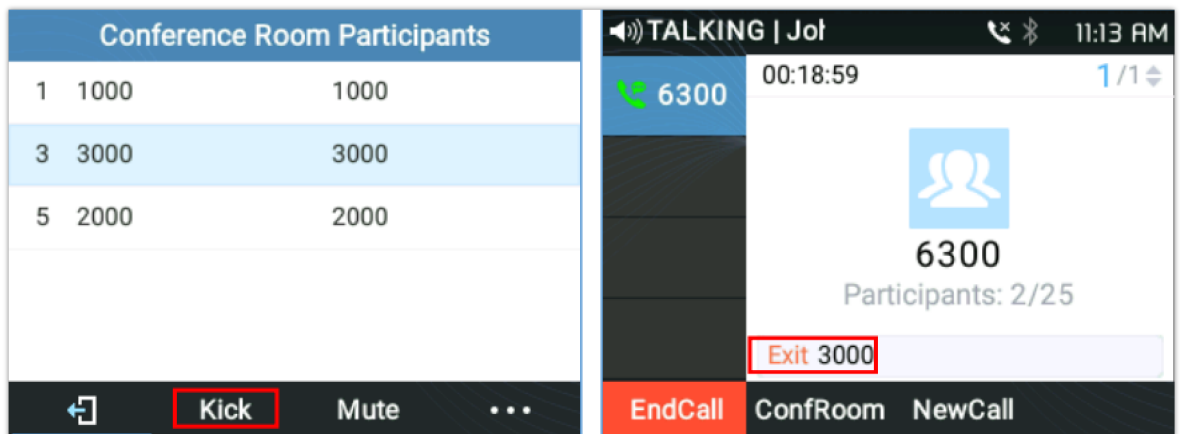

UCM Conference room – Kick user

- **Mute/Unmute User:**

Select the user's extension then press **Mute**. The phone will note the operation by displaying [**Exit User\_Extension**] on the conference home screen. But the user will still be available on the Conference Room Participants List.

An **Unmute** softkey will show to cancel the operation.

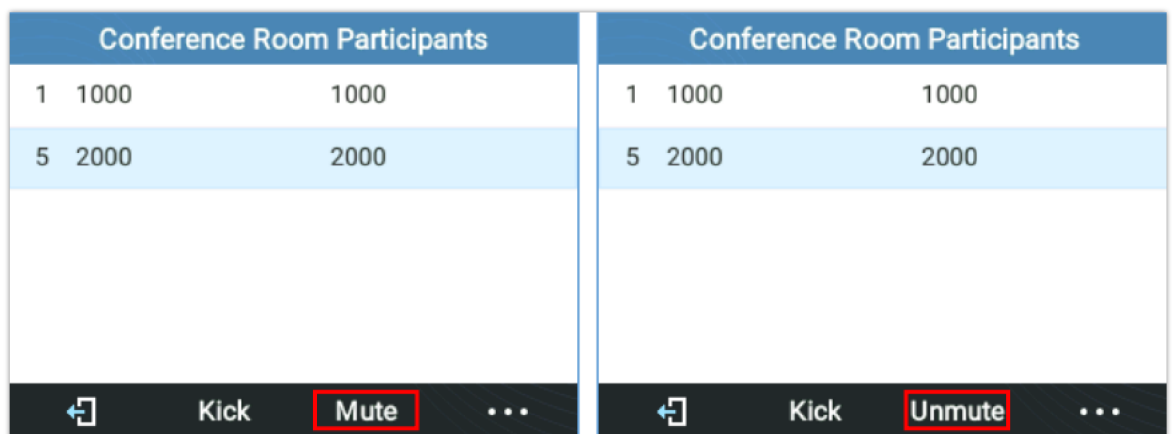

UCM Conference room – Mute/ Unmute user

- **Conference Bridge:**

To bridge another conference, enter the conference number and password and a Bridge request will be sent.

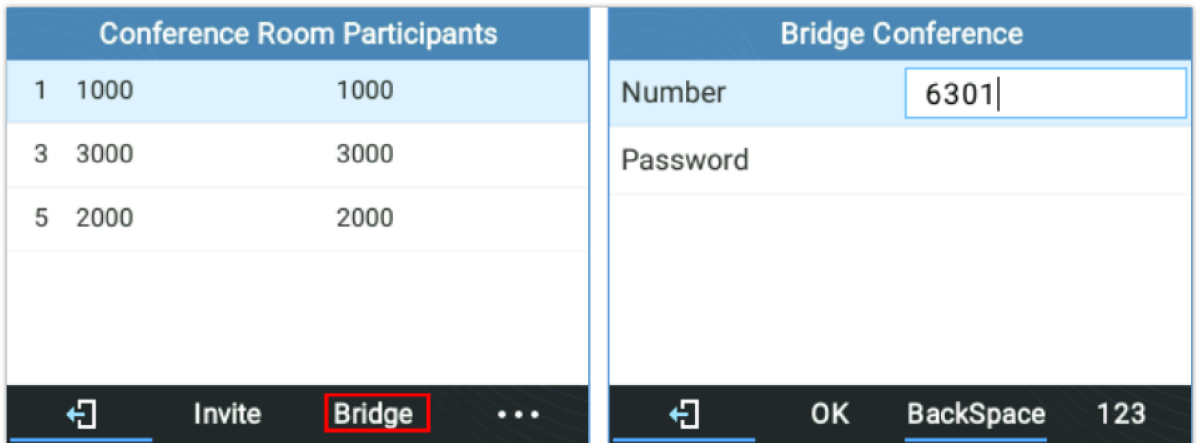

UCM Conference Menu – Bridge Conference

- **More:**

Press [...] for more conference room operations. Users can choose to **Lock/ Unlock** the conference, **Kick All**, or **Mute/ Unmute All** participants.

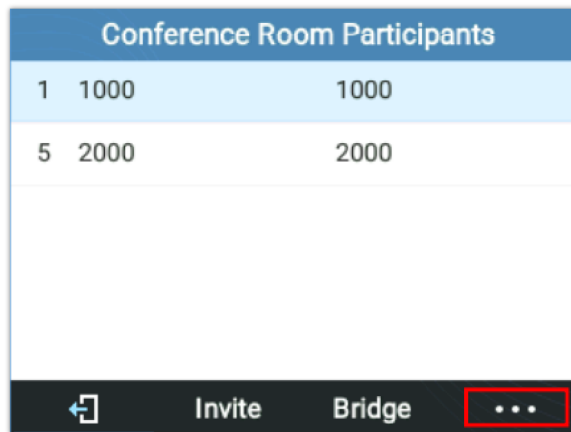

UCM Conference Menu – More

## Call Forwarding

Under **Menu (OK) → Phone → Call Features → Account X**.

- When disabled the LCD screen will look like the following figure:

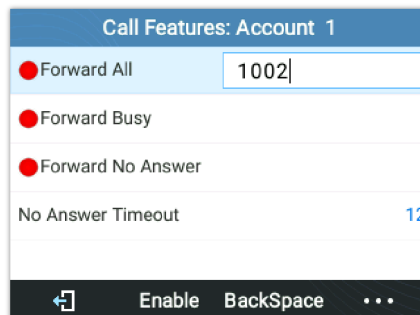

Disabled Call Forward

- When the feature is enabled, the phone's LCD screen will show the following figure.

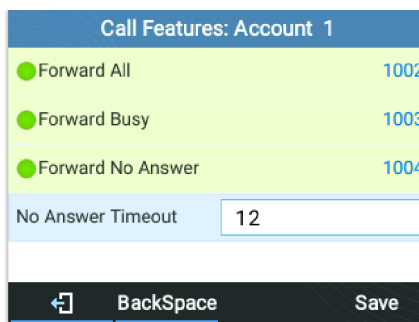

Enable Call Forward

- When forwarding a call, the recipient will display a “diverted from” message.



Diversion Information

- A Call Forward using BLF can also be performed by pressing the BLF key set on VPK/MPK as a forward destination. You only need to Subscribe to a valid BLF and press Forward Key then the BLF key to perform the call forward.

## Voice Mail

A blinking green MWI (Message Waiting Indicator) on the top right corner of the phone indicates a message is waiting. Check the voicemail by retrieving the message by entering the voice mail number of the server; Or by pressing the Voicemail button; or from the Phone's **Menu > Messages > Voice Mails**

### Notes

- Voice Mail User ID and the voice mail number must be properly configured: under **Web GUI→Account X→General Settings**.
- An IVR will prompt the user through the process of message retrieval.

## Virtual Voice Mail

With this feature, the phone downloads the voicemail into a .wav file and stores it. Users don't have to dial feature codes and go to the BroadSoft server to listen to their voice mails. Also, they can pause/resume their voicemail messages at any time they want.

For more information, please refer to the admin guide.

<https://documentation.grandstream.com/knowledge-base/grp261x-grp262x-grp263x-series-administration-guide/>

## Instant Messages

The GRP2612/GRP2612P/GRP2612W/GRP2612G/GRP2613/GRP2614/GRP2615/GRP2616/GRP2624/GRP2634/GRP2636/GRP2670/GRP2650 allows users to send instant messages through the phone's LCD. Under **MENU (OK) → Messages → Instant Messages**

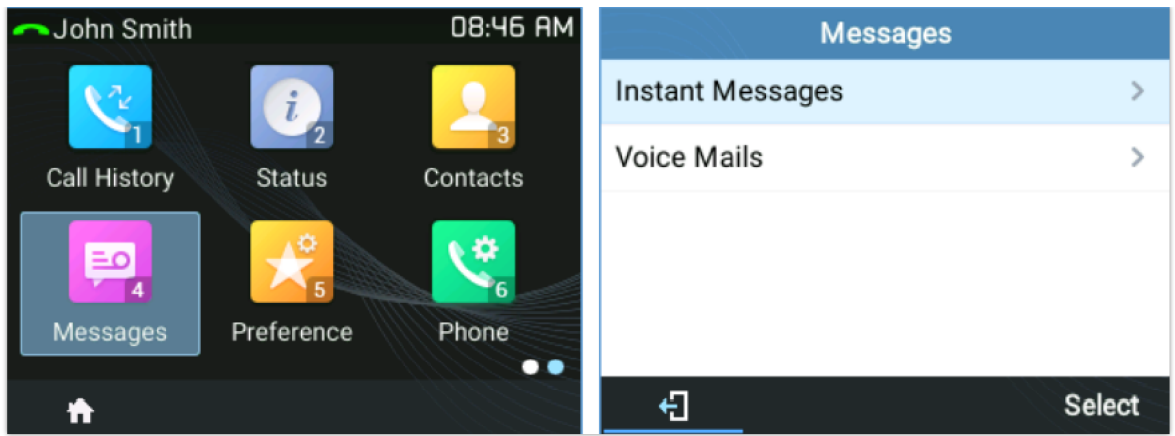

Instant Messages sub-menu

Users can press the “New” soft key, then specify the Account, the recipient, and the contents of the IM.

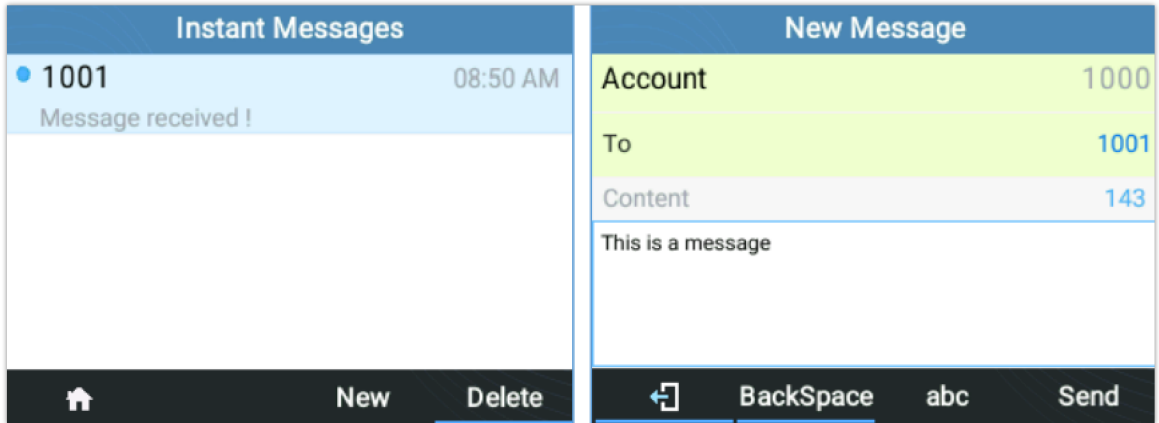

Sending an Instant Message

After pressing the “Send” soft key, a “Sent successfully” message will pop up to indicate that the operation was successful.

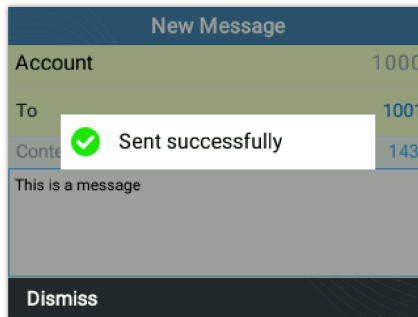

IM Sent Successfully

### Call Features

The GRP261X/GRP2624/GRP263x/GRP2670/GRP2650 supports traditional and advanced telephony features including caller ID, caller ID with caller Name, call forward, etc.

*30	<p><b>Block Caller ID</b> (for all subsequent calls)</p> <ul style="list-style-type: none"> <li>• Off hook the phone.</li> <li>• Dial *30</li> </ul>
*31	<p><b>Send Caller ID</b> (for all subsequent calls)</p> <ul style="list-style-type: none"> <li>• Off hook the phone.</li> <li>• Dial *31</li> </ul>
*50	<p><b>Disable Call Waiting</b></p> <ul style="list-style-type: none"> <li>• Off hook the phone.</li> </ul>



	<ul style="list-style-type: none"> <li>● Dial *50</li> </ul>
*51	<p><b>Enable Call Waiting</b></p> <ul style="list-style-type: none"> <li>● Off hook the phone.</li> <li>● Dial *51</li> </ul>
*67	<p><b>Call with Caller ID Blocked (per call)</b></p> <ul style="list-style-type: none"> <li>● Off hook the phone.</li> <li>● Dial *67 and then enter the number to dial out.</li> </ul>
*82	<p><b>Call with Caller ID Enabled (per call)</b></p> <ul style="list-style-type: none"> <li>● Off hook the phone.</li> <li>● Dial *82 and then enter the number to dial out.</li> </ul>
*70	<p><b>Call with Call Waiting Disable (per call)</b></p> <ul style="list-style-type: none"> <li>● Off hook the phone.</li> <li>● Dial *70 and then enter the number to dial out.</li> </ul>
*71	<p><b>Call with Call Waiting Enabled (per call)</b></p> <ul style="list-style-type: none"> <li>● Off hook the phone.</li> <li>● Dial *82 and then enter the number to dial out.</li> </ul>
*72	<p><b>Unconditional Call Forward.</b></p> <ul style="list-style-type: none"> <li>● Off hook the phone.</li> <li>● Dial *72 and then enter the number to forward the call.</li> <li>● Press OK softkey or SEND key.</li> </ul>
*73	<p><b>Cancel Unconditional Call Forward.</b> To cancel the unconditional call forward:</p> <ul style="list-style-type: none"> <li>● Off hook the phone.</li> <li>● Dial *73.</li> <li>● Hang up the call.</li> </ul>
*90	<p><b>Busy Call Forward.</b> To set up busy call forward:</p> <ul style="list-style-type: none"> <li>● Off hook the phone.</li> <li>● Dial *90 and then enter the number to forward the call.</li> <li>● Press OK softkey or SEND key.</li> </ul>
*91	<p><b>Cancel Busy Call Forward.</b> To cancel the busy call forward:</p> <ul style="list-style-type: none"> <li>● Off hook the phone.</li> <li>● Dial *91.</li> <li>● Hang up the call.</li> </ul>
*92	<p><b>Delayed Call Forward.</b> To set up delayed call forward:</p> <ul style="list-style-type: none"> <li>● Off hook the phone.</li> <li>● Dial *92 and then enter the number to forward the call.</li> <li>● Press OK softkey or SEND key.</li> </ul>
*93	<p><b>Cancel Delayed Call Forward.</b> To cancel the delayed call forward:</p> <ul style="list-style-type: none"> <li>● Off hook the phone.</li> <li>● Dial *93.</li> <li>● Hang up the call.</li> </ul>

Users may proceed as below:

1. Dial Star key (\*): A list of all available feature codes will be displayed on the screen
2. Browse the codes using the UP/Down arrow keys
3. Select an option by pressing the MENU key; Or,  
Click "Dial" Softkey.

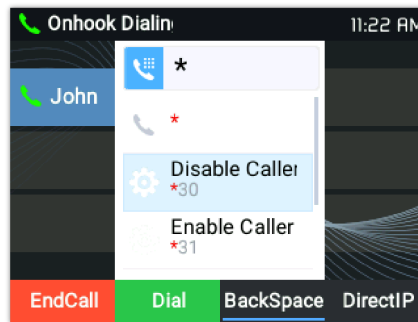

Feature Codes List

## ADVANCED FEATURES

### Virtual Multi-Purpose Keys

#### Web UI Configuration

Users can find the Virtual Multi-Purpose Keys (VPK) configuration under the phone's web UI → **Settings** → **Programmable Keys** → **Virtual Multi Purpose Keys** tab. It is recommended to select "Reset" on this page before configuring VPK here. By default, all fixed VPKs are listed.

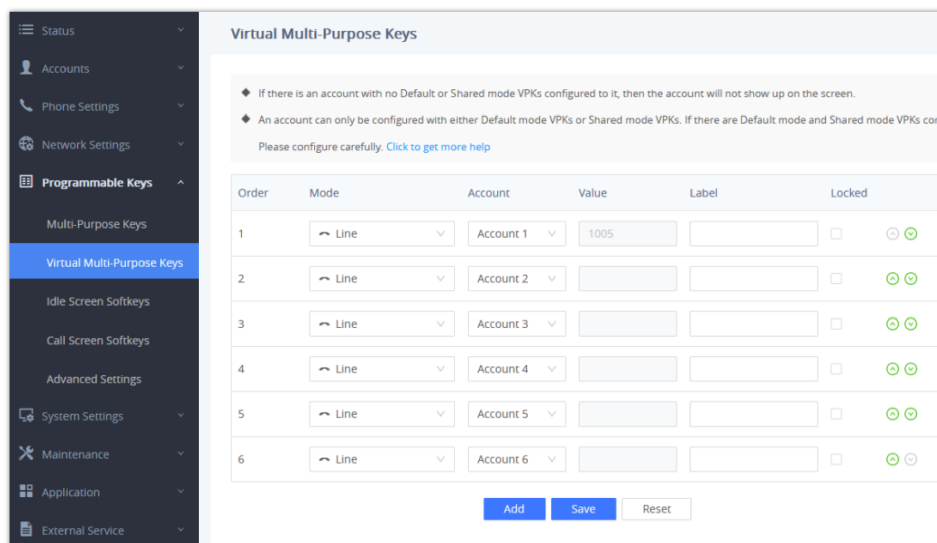

VPK Page

On the Virtual Multi-Purpose Keys page. Select the **Mode** from the drop-down list, and choose the account associated with the VPK. Users can also set the **Value** and the **Label** (description) of the configured VPK.

Order	Mode	Account	Value	Label	Locked
1	Line	Account 1	1005		<input type="checkbox"/>
2	Line	Account 2			<input type="checkbox"/>
3	Line	Account 3			<input type="checkbox"/>
4	Line	Account 4			<input type="checkbox"/>
5	Line	Account 5			<input type="checkbox"/>
6	Line	Account 6			<input type="checkbox"/>

*VPK Configuration*

If users would like to configure more VPKs than the ones displayed on the page, they can click on **"Add VPK"** to configure dynamic VPK.

**Note**

1. Dynamic VPK does not support "Default" and "Shared" modes. These two mode options are only available for fixed VPKs.
2. Dynamic VPK does not support NONE mode. If users do not need this VPK, click on **"Edit VPK"** for it and select **"Delete"** to remove it.
3. All settings require the user to click on **"Save"** on the prompted window and the **"Save VPK"** button at the bottom of the Virtual Multi-Purpose Keys page to take effect.
4. It's recommended to have at least two lines in **Default** mode, to be able to bring up another line during a call and perform whether a call pickup, an attended transfer, or a conference call.

**P-Value for VPK Mode in String Format:**

Mode Name	Mode String	Mode P-Value
None	None	-1
Default	Line	31
Shared	Shared line	32
Speed Dial	Speed dial	0
Busy Lamp Field	BLF	1
Presence Watcher	presencewatcher	2
Eventlist BLF	eventlistblf	3
Speed Dial via Active Account	speeddialaa	4
Dial DTMF	dialdtmf	5
Voice Mail	voicemail	6
Call Return	callreturn	7
Transfer	transfer	8

<b>Call Park</b>	callpark	9
<b>Monitored Call Park</b>	Monitoredcp	16
<b>Intercom</b>	Intercom	10
<b>LDAP search</b>	Ldap Search	11
<b>Conference</b>	Conference	12
<b>Multicast Paging</b>	Multicast paging	13
<b>Record</b>	Record	14
<b>Call Log</b>	Call log	15
<b>Menu</b>	Menu	17
<b>XML Application</b>	Xmlapp	18
<b>Information</b>	Information	19
<b>Message</b>	message	20
<b>Forward</b>	forward	21
<b>DND</b>	DND	22
<b>Redial</b>	redial	23
<b>Instant Messages</b>	instant messages	24
<b>Multicast Listen Address</b>	multicast listen address	25
<b>Keypad Lock</b>	keypad lock	26
<b>GDS OpenDoor</b>	gds opendoor	27
<b>Presence EventList</b>	presence eventList	28
<b>Provision</b>	provision	29

*VPK Modes in String Format*

The string could be capital or lower-case letters, but there must be no "space" in between. For example, in the cfg.xml, "Transfer" or "transfer" the same as "8", it will configure Virtual Multi-Purpose Key 3 as transfer mode.

```

<?xml version="1.0" encoding="UTF-8" ?>
<gs_provision version="1">
  <config version="1">
    <P1363>transfer</P1363>
    <P1364>2</P1364>
    <P1465>TEST</P1465>
    <P1466>7777</P1466>
  </config>
</gs_provision>

```

*Line Key as Transfer Mode*

**LCD Indication and Configuration:**

The configured fixed VPKs are displayed next to the corresponding line. If dynamic VPKs are configured, the users can see a page number shown on the bottom left corner of the LCD.

The following figures show page 1 and page 2 of the VPKs on LCD. Pressing the "RIGHT" arrow key will switch to the next page; pressing the "LEFT" arrow key will switch back to the previous page.

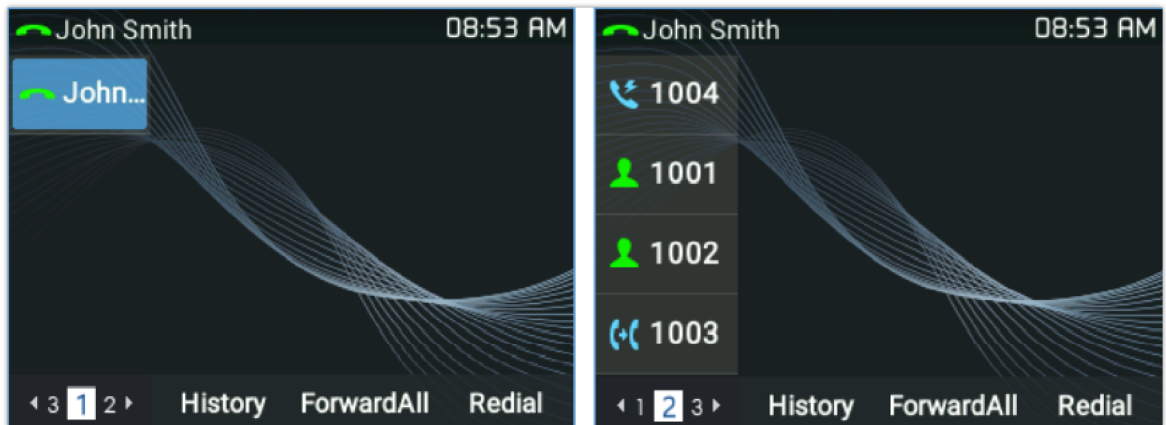

VPK – LCD Indication





































The users could also edit and add VPK from LCD.























1. To edit (fixed) VPK, press and hold the line key for about 4 seconds, and a configuration window will pop up for the user to configure.
2. To add (dynamic) VPK, press and hold the RIGHT arrow key for about 4 seconds, and a configuration window will pop up for the user to configure.
3. During a call, when the phone is on the call screen users can press and hold the VPK for 3 seconds to display the whole description label, switch back the users can wait for 5 seconds or press the VPK again.







Up to 33 modes can be supported on fixed VPK and up to 30 modes can be supported on dynamic VPK. Each mode is indicated by a different icon on the LCD and the icon will be different when in different states.

Please find the icon indications below for different modes of VPK:

VPK Mode	Description	Default	Reverse
LINE	Unregistered		
	Registered		
	Call Forward		
	Dial_1_open_voicemail		
	Dial_2_open_voicemail		
	Account_1_open_voicemail		
	Account_2_open_voicemail		
SCA	Connect		
	Hold		

	Idle		
	Ringing		
	Seized		
	Error		
	Invalid		
	Unknown		
<b>BLF</b>	Away		
	Available		
	Unavailable		
	Busy		
	Chat		
	Connect		
	DND		
	Ringing		
	Unknown		
	User def		
<b>Speed Dial</b>	Speed Dial		
<b>Dial DTMF</b>	Dial DTMF		
<b>Call Return</b>	Call Return		
<b>Transfer</b>	Call transfer		

<b>Call Park</b>	Call Park		
	Call Park Busy		
	Call Park Online		
	Call Park Offline		
<b>Intercom</b>	Intercom		
	Multicast Intercom		
	Paging Call		
<b>LDAP Search</b>	LDAP Search		
<b>Multicast Paging</b>	Multicast Listen Address		
<b>Record</b>	Recording		
<b>Menu</b>	Menu		
<b>Message</b>	Message		
<b>Conference</b>	Conference		
<b>Information</b>	Information		
<b>Keypad Lock</b>	Keypad Lock		
<b>DND</b>	Do Not Disturb		
<b>XML</b>	XML		
<b>Phonebook</b>	Phonebook		
<b>Call History</b>	Call History		
<b>Instant Message</b>	Instant Message		

<b>Redial</b>	Redial		
<b>GDS OpenDoor</b>	GrandStream OpenDoor System		
<b>Forward</b>	Forward		
<b>Provision</b>	Provision		
<b>Voice Mail</b>	Voice Mail		
	Voice Mail New		

*VPK Modes Icon Indications*

When the user is on the call screen (during a call), he can press the Right/Left arrow key to toggle between screens and choose which VPK to use.

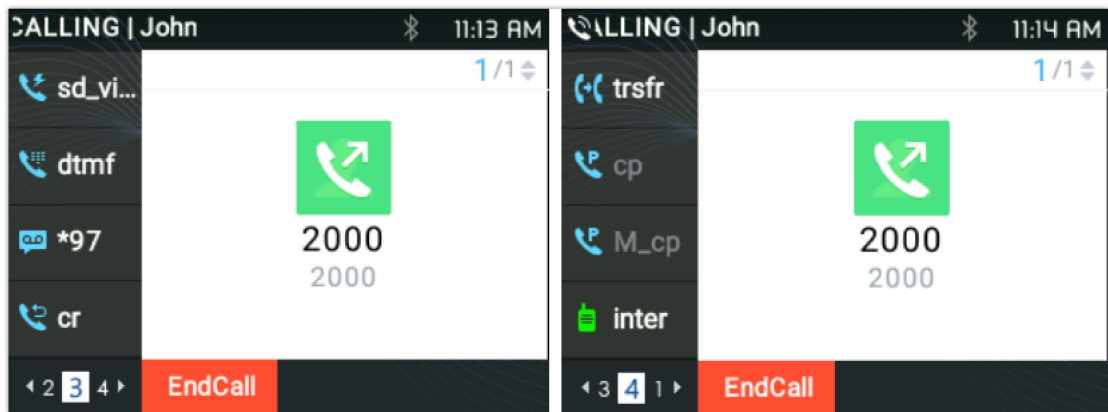

*Toggle Between Screens on The Call Screen*

**Notes**

- If a call is parked via the VPK call park, the display on the VPK will change between the CID of the active call and the parking number.
- When changing the VPK information that requires a subscription, the phone will perform unsubscribe first, then perform a new subscription. This way server will know that the previous subscription has been void.

**Predictive Dialing**

**Search in Call History**

**Functionality**

If the user dials digits matching some call history entries, a list of entries should be displayed with corresponding names.

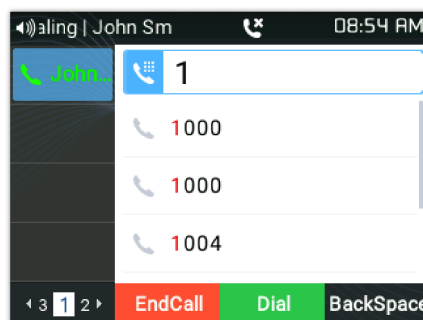



**Note**

Users can Disable the Predictive Dialing Feature from Web GUI under **Settings → Call Features**.

**Search in Broadsoft Directories**

**Web configuration**

Users can configure Broadsoft XSI directories correctly from Web GUI under **External Service → Broadsoft Xsi**.

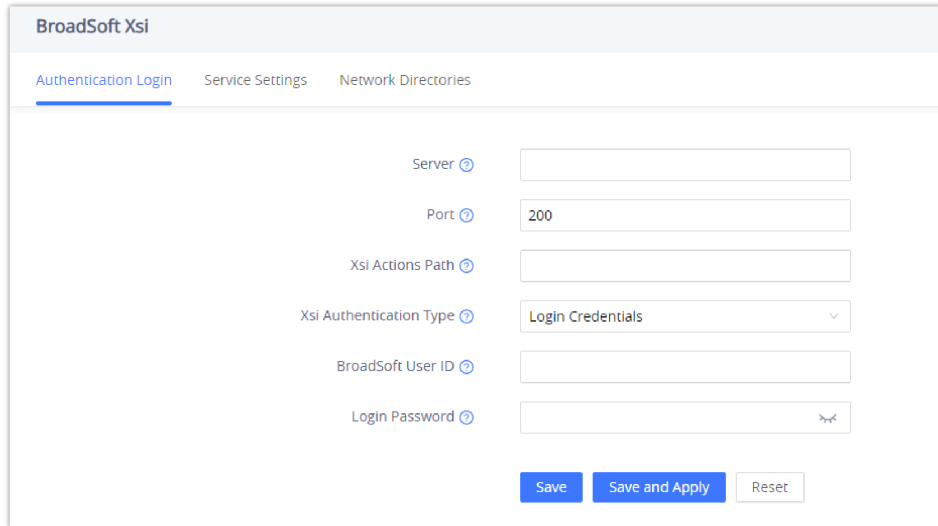

*Broadsoft XSI web configuration*

**Functionality**

The phone can predict possible contact information from Broadsoft XSI directories when users dial a number. Users can select from the list of predicted numbers that will show if Broadsoft XSI directory information is loaded after pressing the related number

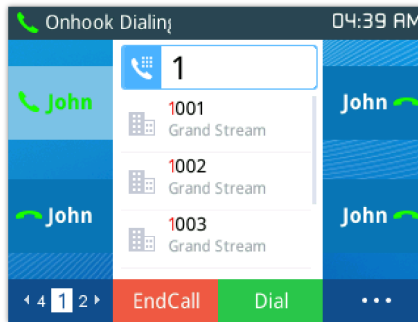

*Predictive Dialing from BS XSI Directories*

**VPK Paging Support inside the LCD Call Screen**

Users can use their preconfigured VPK mode while on the call screen. Such as Speed Dial, BLF..., as shown in the figure below:

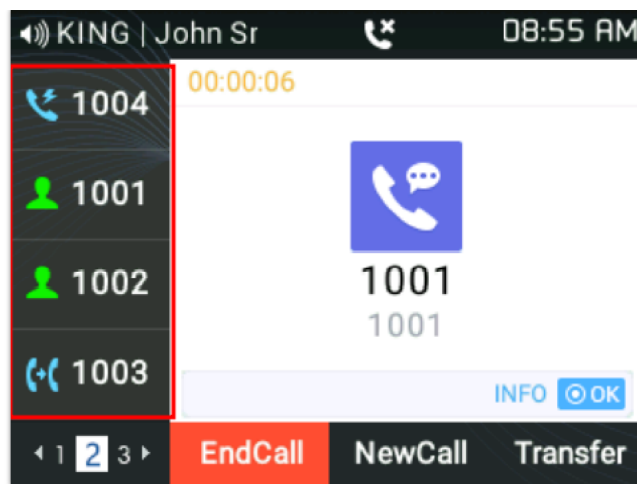

VPK Paging

## Active VPK Page

If “**Active VPK page**” is enabled, when a monitored BLF number is called, the LCD screen will indicate the VPK Page that contains the VPK key below



Active VPK Page

You can see the page number blinking in red, which means that this page is an active VPK page. Users can Enable/Disable this option under device **web UI → Settings → Call Features**

## Line Switching in Call Screen

When having two lines (or more) active users will be able to switch between the calls by pressing up/down, arrow keys, this will allow users to manipulate calls through the phones arrow keys as shown below:

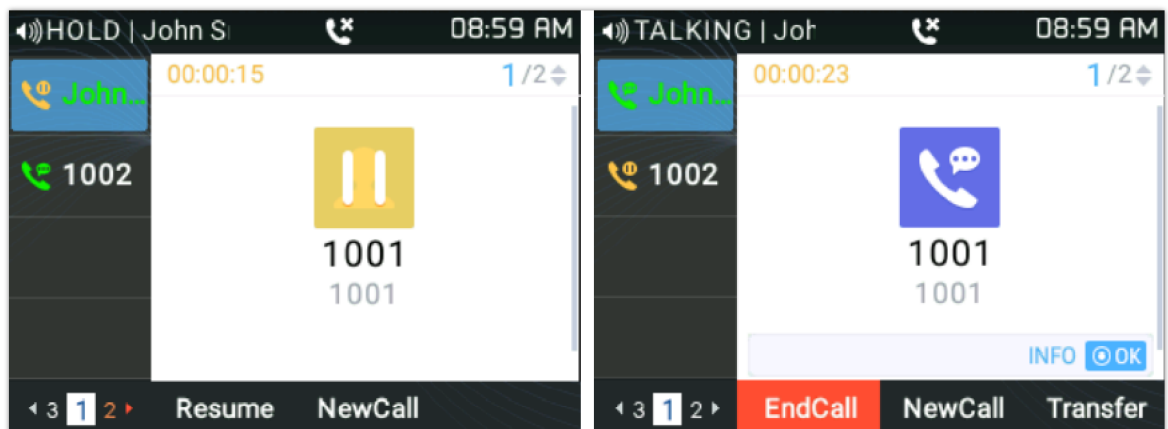

Line Switching

## Shared Call Appearance (SCA)

The GRP2612/GRP2612P/GRP2612W/GRP2612G/GRP2613/GRP2614/GRP2615/GRP2616/GRP2624/GRP2634/GRP2670/GRP2650 phone supports shared call appearance by Broadsoft standard. This feature allows members of the SCA group to share SIP lines and provides status monitoring (idle, active, progressing, hold) of the shared line.

To enable the shared call appearance, the user needs to register the shared line account on the phone. In addition to configuring the SCA parameters under **Settings → Programmable Keys** on the web UI and setting the line key mode as “Shared Line”.

For more information please refer to the SCA guide:

[https://www.grandstream.com/hubfs/Product\\_Documentation/GXP\\_BS\\_SCA\\_conf\\_Guide.pdf?hsLang=en](https://www.grandstream.com/hubfs/Product_Documentation/GXP_BS_SCA_conf_Guide.pdf?hsLang=en)

## Configuring Eventlist BLF

Grandstream GRP261X/GRP2624/GRP2634/GRP2636/GRP2670 Carrier-Grade IP Phones support both Grandstream UCM Busy Lamp Filed and Event List BLF features and allows end-users, such as attendant, to monitor the call status of users in the list.

GRP261X/GRP2624/GRP2634/GRP2636/GRP2650/GRP2670 supports this feature by sending out the subscription request to the UCM and changing the indicator status of the Line keys, MPKs, or virtual MPKs that are associated with the monitored users.

Additionally, the phone is also able to display the original caller’s call ID and to pick up the calls to the monitored extensions by using a pre-defined feature code called BLF- Call-pickup Prefix.

For more details on the Eventlist BLF configuration guide, please refer to:

<https://documentation.grandstream.com/knowledge-base/how-to-configure-eventlist-blf/>

## Screenshots

Users can take screenshots of the GRP261X/GRP2624/GRP263x/GRP2670/GRP2650 Screen, by pressing and holding the “**HOLD**” key and then the “**MENU**” key, the output will be shown on the phone’s Web GUI under “Status → System Info” as shown in the figure below:

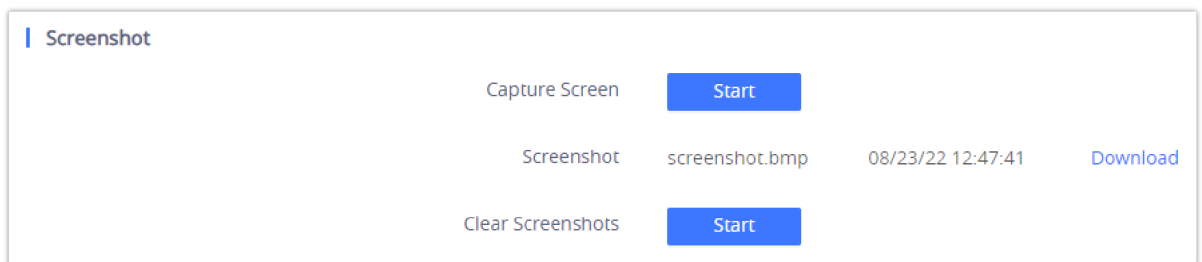

*Screenshots*

- Users can “Download” and then view the screenshot.
- Users can clear the available Screenshots by pressing “Start”

## Diagnosis

Users could access the factory functions menu in order to diagnose the phone’s hardware/software. To do so please access to LCD menu under **System → Factory Functions** or use the shortcut by pressing the “HOLD” Key and the “Up-arrow” key at the same time.

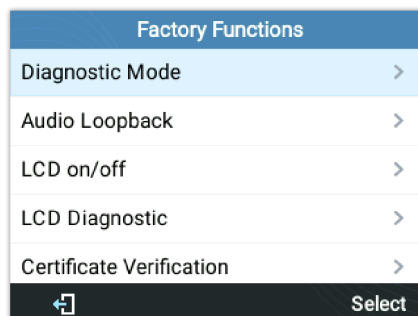

*Factory Functions*

These tools can be used to check the hardware and software status of the phone like verifying the LED, keypad buttons, LCD and certificates verification ...etc.

# CONTACTS

## Local Contacts

Users can manage contacts by adding, deleting, and modifying single contacts, downloading contacts from HTTP/TFTP server, importing contacts from external storage, and exporting contacts to external storage.

For more details please refer to the admin Guide:

<https://documentation.grandstream.com/knowledge-base/grp261x-grp262x-grp263x-series-administration-guide/>

## Add a single Contact

On the Local Contacts menu, select Local Phonebook then press the "New" soft key. The phone will display the following:

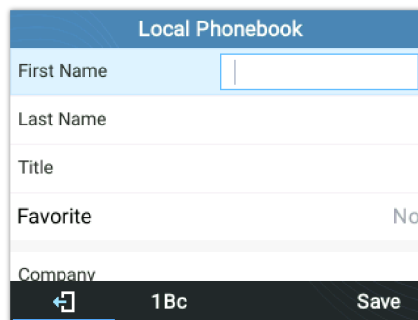

*New Contact*

Input the contact details then press "Save" soft key. The new contact will be added to your local phonebook.

## Phonebook

### XML Phonebook syntax

Users can add contacts using the below syntax in the *phonebook.xml* file:

```
<AddressBook>
  <Contact>
    <id>1</id>
    <FirstName>abc</FirstName>
    <LastName>def</LastName>
    <JobTitle>jobtitle</JobTitle>
    <Frequent>0</Frequent>
    <Phone type="Work">
      <phonenumber>1111</phonenumber>
      <accountindex>0</accountindex>
    </Phone>
    <Phone type="Home">
      <phonenumber>2222</phonenumber>
      <accountindex>0</accountindex>
    </Phone>
    <Phone type="Mobile">
      <phonenumber>3333</phonenumber>
      <accountindex>0</accountindex>
    </Phone>
    <Primary>1</Primary>
    <Department>department</Department>
    <Job>job</Job>
    <Title>title</Title>
    <Company>company</Company>
  </Contact>
</AddressBook>
```

## Download/Upload XML Phonebook from Web UI

From the phone's web interface under **Application → Contacts → Phonebook Management**, Use the button "Download" to retrieve the XM phonebook currently configured on the phone. Press the button "Upload" to choose your XML phonebook to upload to the phone.

The screenshot shows the 'Phonebook Management' section of the web interface. It includes several configuration fields:

- Enable Phonebook XML Download: Disabled
- HTTP/HTTPS Username: [Empty]
- HTTP/HTTPS Password: [Empty]
- Phonebook XML Server Path: [Empty]
- Phonebook Download Interval: 0
- Remove Manually-edited Entries on Download:
- Import Group Method: Replace
- Sort Phonebook by: Last Name
- Download XML Phonebook: Download
- Upload XML Phonebook: Upload
- Phonebook Key Function: Default
- Default Search Mode: Quick Match
- Replace Duplicate Items: No

At the bottom, there are three buttons: Save, Save and Apply, and Reset.

Download/Upload XML Phonebook

On the LCD screen, under Contacts. The phone will display the following:



Local Phonebook – Contact Information

Users can also input the "Company", "Title", and "Job" fields on the **phonebook.xml** like in the previous example or through the phone's LCD pressing the "Edit" soft key, as below:

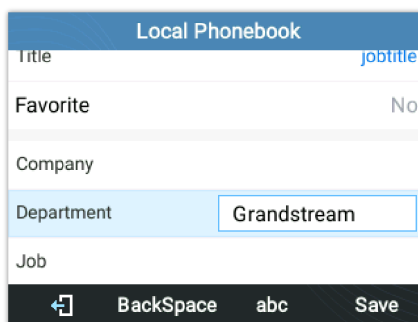

Local Phonebook – Company/Title/Job Fields

## Dialed Numbers Filtering

After downloading the phonebook, when dialing a number from the contacts, the number may include special characters such as "()", "- ", or space in between numbers.

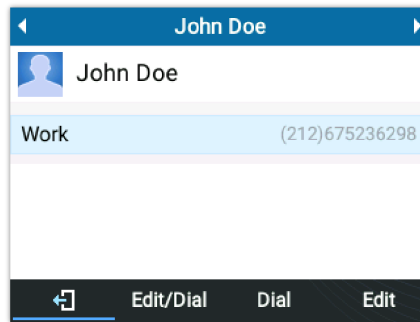

*Contact Numbers with Special Characters*

When pressing the Dial softkey, the phone will filter the special characters and make the calls send out properly.

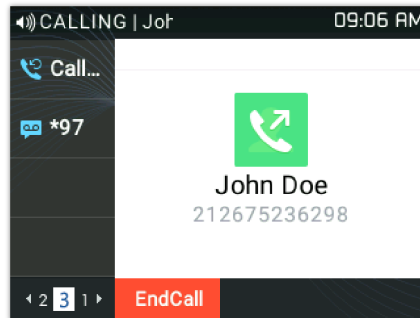

*Call with Filtered Characters*

## Contact search mode

### Quick Match

The quick search feature allows users to search parts and strings of the entries. For instance, if users only remember the first name, last name, parts of the name/phone number, they can use the string in the search bar as displayed in the following screenshots:

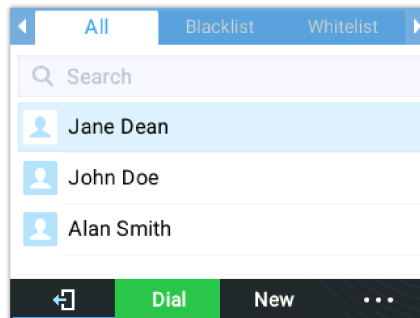

*Before Search*

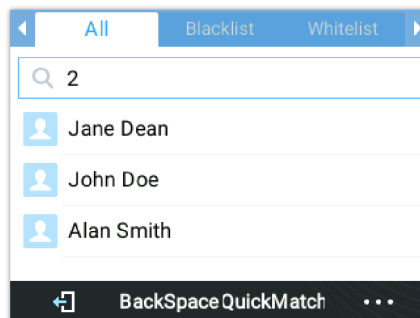

*QuickMatch*

### Exact Matching

Users can search their contacts using alphabets in the exact mode which allows them to find their contacts even if they forget the numbers. To perform this type of search, make sure that the search type is set to "ExactMatch" as shown in the following figure, then you can enter the exact name of the contact for lookup.

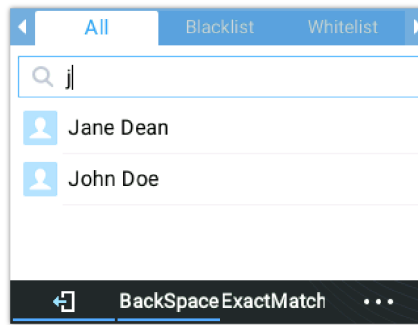

*ExactMatch*

## LDAP

### Functionality

Users can search contacts on the LDAP server from Contacts Menu, under LDAP Directory. This option can be configured under device **web UI** → **Phonebook** → **LDAP**. For further information, please refer to the admin guide.

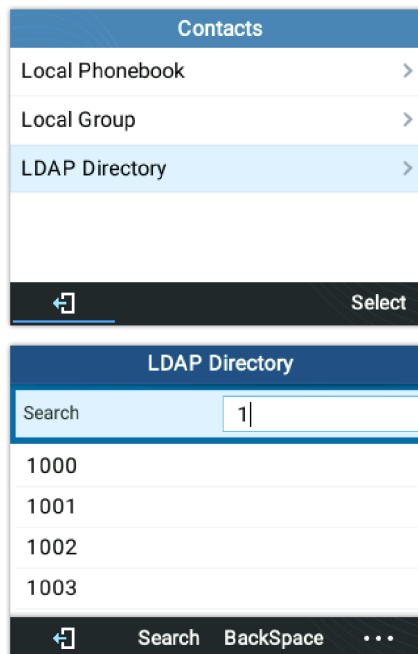

*LDAP search*

## Broadsoft Directories

### Functionality

Users can also search from the Broadsoft directories by entering target content in the search form. This option can be configured under device **web UI** → **Settings** → **Broadsoft**. For further information, please refer to the admin guide.

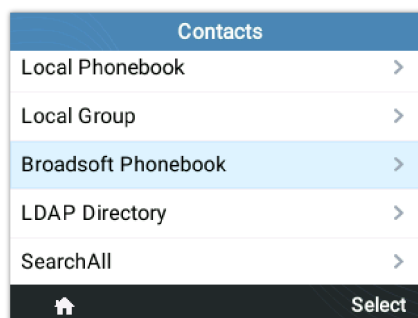

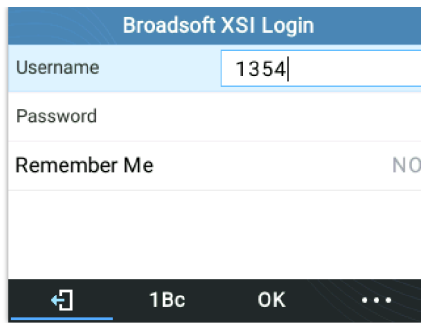

Search in Broadsoft Directories

## CALL HISTORY

### Local Call History

There are five different categories in the local call history. Users could use the navigation keys to browse call logs:

- **All** : 📞
- **Missed** : 📞
- **Dialed** : 📞
- **Answered** : 📞
- **Transferred** : 📞

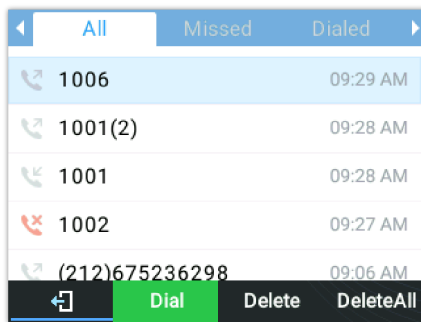

Call History Screen Page

- **Dial**: Tap on one of the call history entries to call this number directly. The phone will use the same account as the call log when dialing
- **Delete**: Select an entry then press the "Delete" soft key
- **DeleteAll**: Clear the call history

### Missed Calls Indication

When users miss a call, the GRP261X/GRP2624/GRP263x/GRP2670/GRP2650 will show the notification on the LCD screen as shown below:

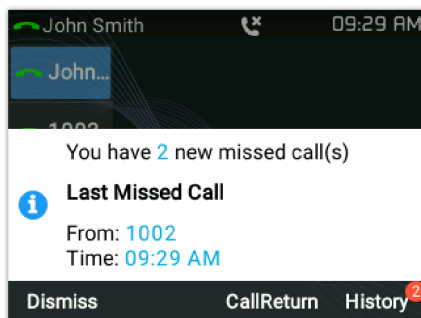

Missed Calls

Users have the option to return the call immediately by clicking the "CallReturn" Softkey.

### Notes





1. Users can set the phone to turn off the LCD backlight while having a missed call. This option can be found under device **web UI → Settings → Preferences → LCD Display → disable missed call backlight**. If users want to have missed call notifications, select yes, bug flash MWI LED.
2. The phone LCD will also display VM notifications in case the voicemail isn't cleared yet.

## CONNECTING TO DEVICES

### EHS Headset

The GRP261X/GRP2624/GRP263x/GRP2670/GRP2650 supports a normal RJ11 headset and Plantronics EHS headset.

To use the Plantronics EHS headset, go to the web GUI → **Settings → Audio Control: Headset Type**. Select "Plantronics EHS" then reboot the phone.

1. Connect EHS Headset (Plantronics) to the phone. Insert headset connector into the RJ11 headset port on the back of GRP261X/GRP2624/GRP263x/GRP2670/GRP2650.
2. To use headset mode, press the headset button . A headset icon  will show on the LCD.

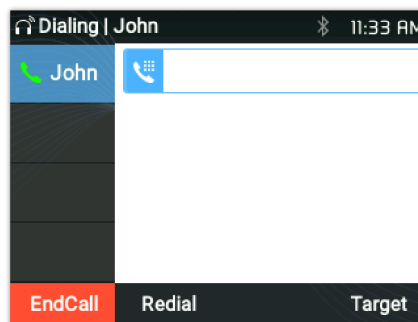

Headset enabled

### Bluetooth

#### Information:

Bluetooth is available on GRP2614, GRP2615 & GRP2616, GRP2624, GRP2634, GRP2636, GRP2670 & GRP2650 only.

GRP2614/GRP2615, GRP2616, GRP2624, GRP2634, GRP2636, GRP2670 & GRP2650 are also capable of connecting to Bluetooth devices. Users could connect to cellphones (supporting Bluetooth) via hands-free mode or use a Bluetooth headset for making calls.

To connect to a Bluetooth device, turn on the Bluetooth radio first. The first time when using a new Bluetooth device with the GRP2614/GRP2615, GRP2616, GRP2624, GRP2634, GRP2636, GRP2670 & GRP2650, "pair" the device with the phone so that both devices know how to connect securely to each other. After that, users could simply connect to a paired device.

Bluetooth-related settings are under the Phone's LCD **Menu → System → Bluetooth**.

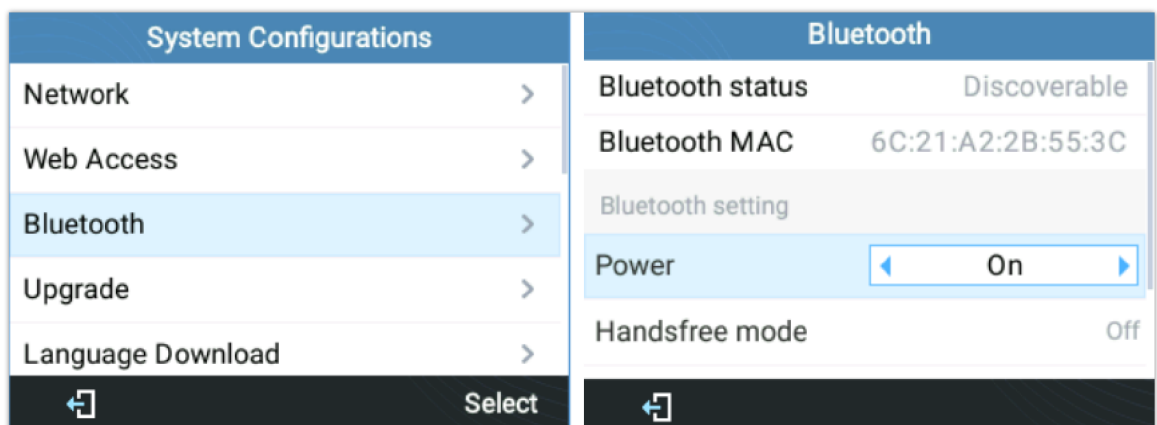

Bluetooth feature

There are two ways to pair the GRP2614/GRP2615/GRP2616/GRP2624/GRP2634/GRP2636/GRP2670 using the Bluetooth feature:

- o **From the GRP2615/GRP2614/GRP2616/GRP2624/GRP2634/GRP2636/GRP2670**

1. Select "Start Scan" to search nearby Bluetooth devices

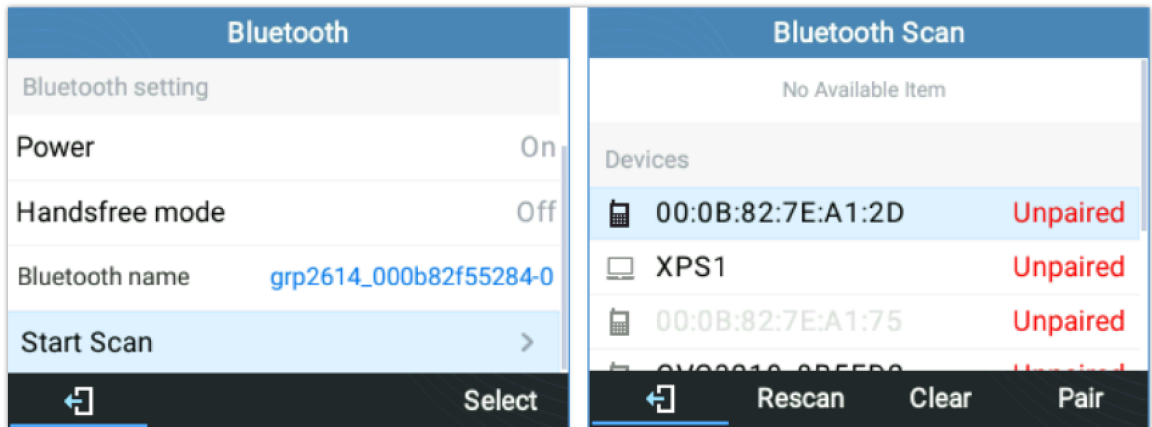

Bluetooth Scan

2. Choose a device then select "Pair". The phone will then start the pairing process

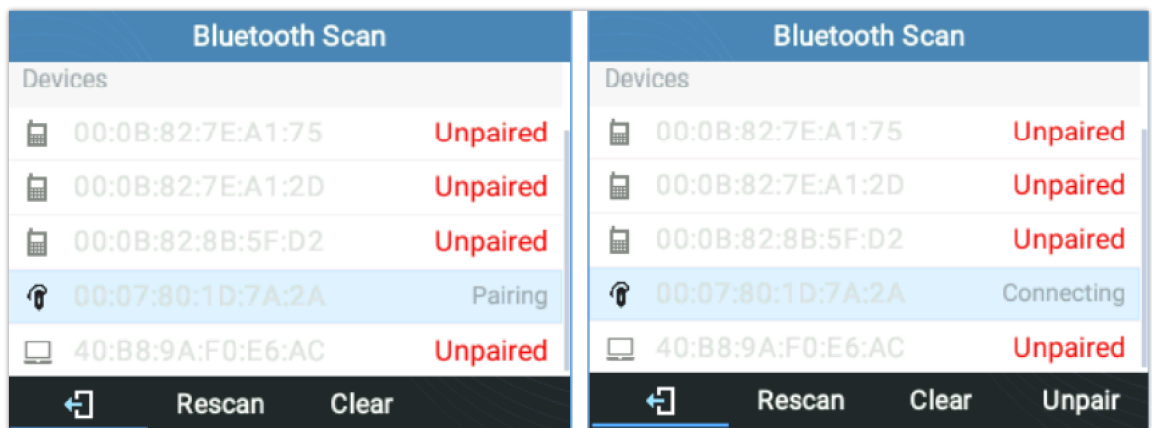

GRP2615/GRP2614/GRP2616/GRP2624/GRP2634/GRP2636/GRP2670/GRP2650 Pairing Process

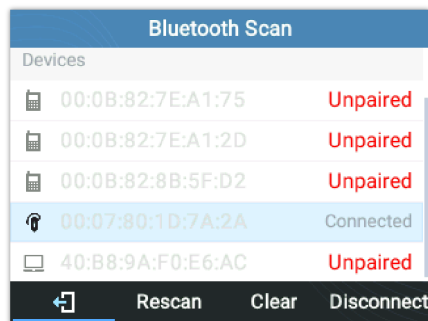

Successful Bluetooth pairing

3. If the pairing succeeds, users will see "Connected" next to the name of the Bluetooth device.

- o **From a Bluetooth different device:**

1. Make sure the Bluetooth is powered on and shows "Discoverable" under "Bluetooth status"

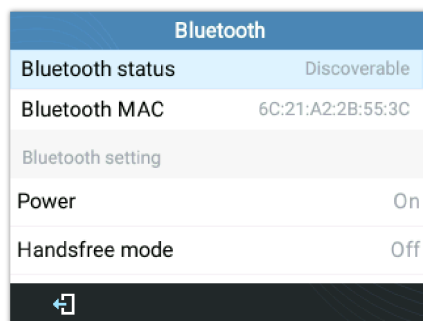

Bluetooth Status

2. Press "YES" to accept the pairing request

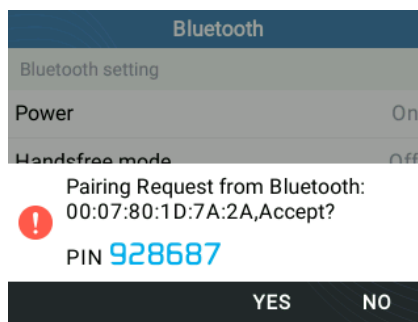

Pairing Request

#### Note

- Turn off Bluetooth if it is not used.
- For more details on the Bluetooth features, please refer to:  
<https://documentation.grandstream.com/knowledge-base/using-bluetooth-on-grp-phones/>

## Wi-Fi

#### Information:

Wi-Fi is supported on GRP2612W, GRP2614, GRP2615, GRP2616, GRP2624, GRP2634, GRP2636, GRP2670 & GRP2650 only.

#### Note

For easy deployment, GRP2612W/GRP2614/GRP2615/GRP2616/GRP2624/GRP263x/GRP2670/GRP2650 out of the box is preconfigured to connect to a default SSID named wp\_master with a password (WPA/WPA2 PSK) equal to **wp!987@dmIn**, for this to work the following criteria needs to be met:

1. The IP phone should not be connected by a LAN cable.
2. No SIP account should be registered on the IP phone.
3. SSIDs from previous connections should not be saved on the IP phone, please factory reset the device to confirm.

To connect these models to a Wi-Fi Network through the keypad menu. Please follow the below steps:

1. On LCD **MENU**, navigate to **System → Wi-Fi settings**.

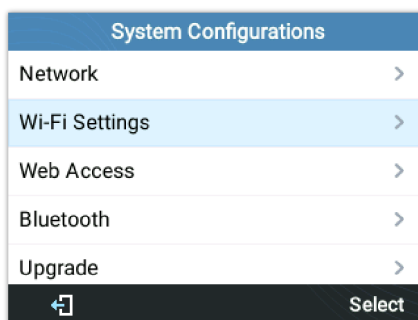

Wi-Fi feature

2. Set Wi-Fi to "Enabled" and press the "Save" button.

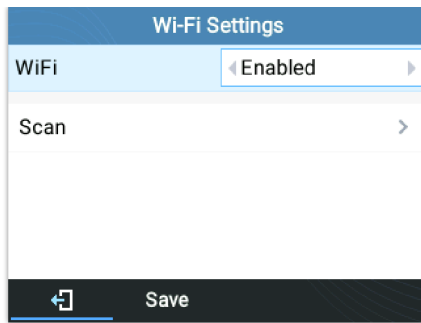

*Enable Wi-Fi*

3. Select "Scan".

The device will automatically start scanning for Wi-Fi access points within the range

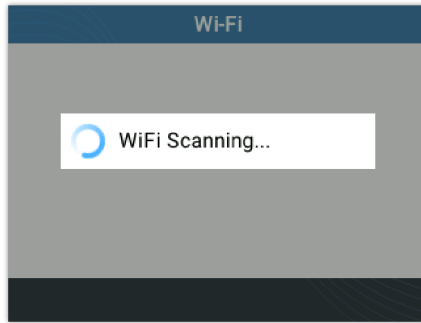

*Wi-Fi Scanning*

4. A list of available Wi-Fi networks will be displayed. Select the desired network,

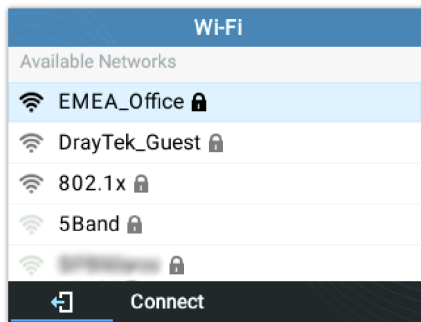

*Nearby Wi-Fi networks*

5. If required, enter the password to connect.

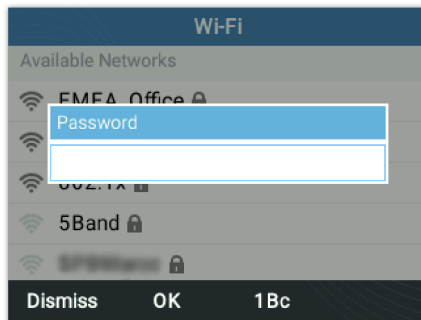

*Wi-Fi password required*

**Note**

- A softkey to show or hide passwords has been added on firmware upgrade 1.0.9.62.

6. An incorrect password will trigger an error message "Cannot connect to the selected network".  
– If the connection is successful a "Wi-Fi NetWork Connected" message will display on the screen

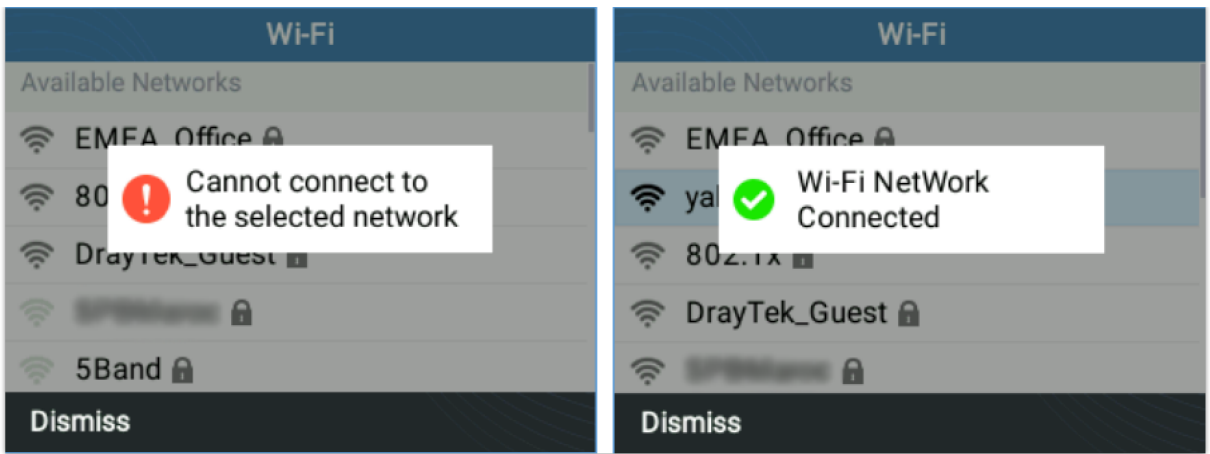

Failed/Successful Wi-Fi connection

7. Check the Wi-Fi icon on the idle screen to verify if the Wi-Fi network is properly connected.

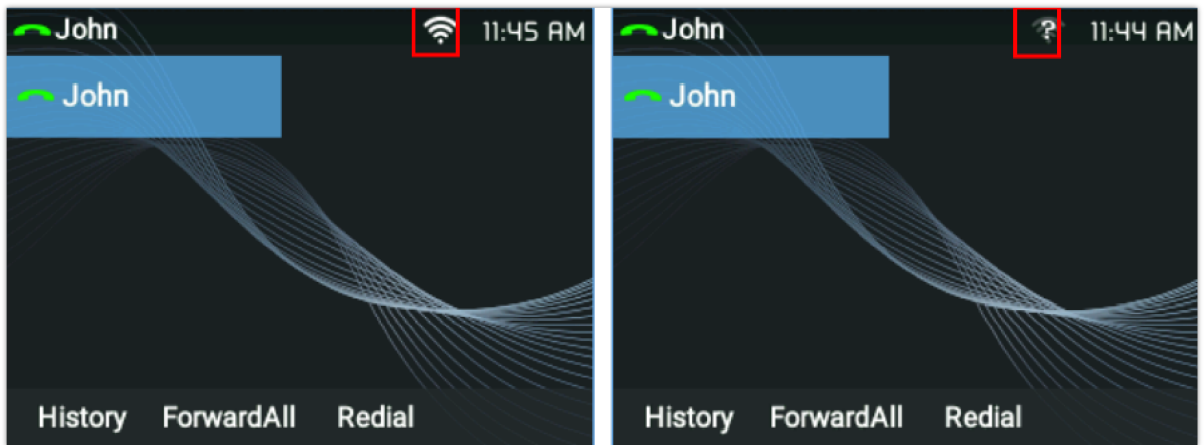

Wi-Fi Status

8. A new section "Current Connection" will show under **System** → **Wi-Fi settings**.

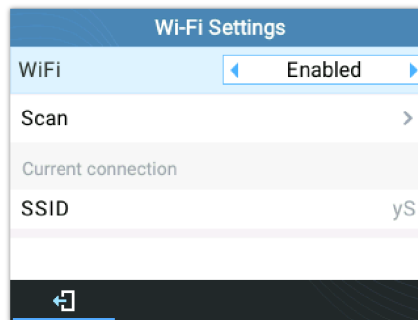

Current connection

9. Selecting "Scan", Users may choose to "Forget" the current connection and establish a new one.

## RESTORE FACTORY DEFAULT SETTINGS

### Warning

Restoring the Factory Default Settings will delete all configuration information on the phone. Please backup or print all the settings before you restore to the factory default settings. Grandstream is not responsible for restoring lost parameters and cannot connect your device to your VoIP service provider.

### Restore factory settings using the LCD menu

Please follow the instructions below to reset the phone:

1. Press the MENU button to bring up the keypad configuration menu.
2. Select "System" and enter.

3. Select “Operations – Factory Reset”.

4. A warning window will pop out to make sure a reset is requested and confirmed.

Press the “Yes” Softkey to confirm and the phone will reboot, or “No” Softkey to cancel the Reset.

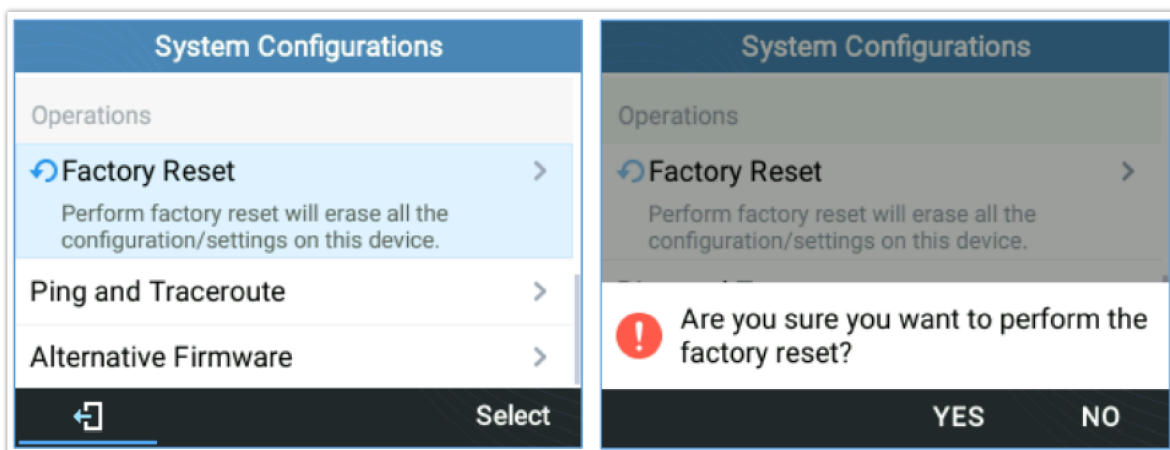

Factory Reset using LCD Menu

## CHANGE LOG

This section documents significant changes from previous versions of user manuals for GRP261X/GRP2624/GRP263x/GRP2670/GRP2650. Only major new features or major document updates are listed here. Minor updates for corrections or editing are not documented here.

### Firmware version 1.0.11.15

- Increased maximum number of SIP accounts for the GRP2612, GRP2613 to 4 SIP accounts and GRP2624, GRP2634 to 6 SIP accounts (with the exception of legacy hardware discontinued in 2020). [[Multiple SIP Accounts and Lines](#)] [[Technical Specifications](#)]

### Firmware Version 1.0.9.141

- No Major Changes.

### Firmware Version 1.0.9.136

- No Major Changes.

### Firmware Version 1.0.9.132

- Added ability to send out star codes to the server while being able to use local call features via LCD. [[Receiving calls](#)]

### Firmware Version 1.0.9.103

- No Major Changes.

### Firmware Version 1.0.9.99

- No major changes.

### Firmware Version 1.0.9.83

- Added the ability to connect to the pre-configured default SSID “wp\_master” on Wi-Fi supported models [[Wi-Fi](#)]

### Firmware Version 1.0.9.74

- Added a softkey to toggle displaying or hiding the WIFI password when inputting the field. [[Wi-Fi](#)]
- Added support for Greek LCD strings.
- Improved Japanese LCD strings.
- Added Energy saving Icon Definition [[GETTING TO KNOW GRP261X/GRP2624/GRP2634/GRP2650](#)]
- Added support for DTMF hard key press to the command element.

### Firmware Version 1.0.9.22

- Added support for GRP2650.
- Modernized the look of the Web UI.
- Added the ability to send DTMF while the DUT has a call waiting on screen. [[Receiving calls](#)]

#### **Firmware Version 1.0.7.33**

- No major changes.

#### **Firmware Version 1.0.7.25**

- No major changes.

#### **Firmware Version 1.0.7.23**

- No major changes.

#### **Firmware Version 1.0.7.22**

- No major changes.

#### **Firmware Version 1.0.7.19**

- Added "Yerevan" to GMT+04:00 Timezone.
- Added option to disable all Local Call Features except Call Forwarding and DND.
- Added support for additional display headers: P-Served-Application and P-Served-User.

#### **Firmware Version 1.0.5.93**

- Added ability to end the call on hold without having to resume it first [[End call](#)]
- Added ability to display the entire VPK description label by holding the VPK for 3 seconds when in call [[VPK description LCD display](#)]
- Added a voicemail notification popup when receiving a new voicemail message or after reboot/reset if there are new(or not played) voicemail messages [[VM notification](#)]

#### **Firmware Version 1.0.5.67**

- No major changes.

#### **Firmware Version 1.0.5.48**

- No major changes.
- This is the initial version for GRP2624/GRP2634.

#### **Firmware Version 1.0.5.45**

- No major changes.

#### **Firmware Version 1.0.5.44**

- No major changes.

#### **Firmware Version 1.0.5.36**

- Added support for a power-saving feature of turning off the LCD display automatically according to a configurable schedule. [[Office Hours](#)]
- Added support for a power-saving feature of turning off the LCD display automatically according to a timer when not during office hours [[Power Saving Timeout](#)]

#### **Firmware Version 1.0.5.33**

- Extended the amount of text that can be displayed on the Extension label.
- Added support for disabling the feature of selecting an account from LCD. [[Multiple SIP Accounts and Lines](#)]

#### **Firmware Version 1.0.5.15**

- Added ability to configure Headset TX/RX gain on LCD. [[Audio](#)]

#### **Firmware Version 1.0.3.6**

- No major change.

#### **Firmware Version 1.0.1.23**

- No major change.

#### **Firmware Version 1.0.1.17**

- No major change.

#### **Firmware Version 1.0.1.7**

- Added support for GRP2616.
- Added support for GRP2615.
- Added support of Bluetooth handsfree feature. [[Bluetooth](#)]
- Improved Features of blocklist and allowlist in Contact. [[Block/Allow Listing](#)]

#### **Firmware Version 1.0.0.31**

- Added support for more MPK/VPK modes [[VIRTUAL MULTI-PURPOSE KEYS](#)]
- UCM conference room updates [[UCM CONFERENCE](#)]

#### **Firmware Version 1.0.0.16**

- This is the initial version for GRP261X.

## **EXPERIENCING GRP261X/GRP2624/GRP263x/GRP2670/GRP2650**

Please visit our website: <https://www.grandstream.com> to receive the most up-to-date updates on firmware releases, additional features, FAQ documentation, and news on new products.

We encourage you to browse our [product-related documentation](#), [FAQ](#), and [User and Developer Forum](#) for answers to your general question: you have purchased our products through a Grandstream Certified Partner or Reseller, please contact them directly for immediate support.

Our technical support staff is trained and ready to answer all your questions. Contact a technical support member or [submit a trouble ticket online](#) to receive in-depth support.

Thank you again for purchasing the Grandstream IP phone, it will be sure to bring convenience and color to both your business and personal

#### **Caution:**

Changes or modifications to this product not expressly approved by Grandstream, or operation of this product in any way other than as detailed by this guide, could void your manufacturer warranty.

#### **Warning:**

Please do not use a different power adaptor with devices as it may cause damage to the products and void the manufacturer warranty

---

#### **GNU GPL Information**

GRP261X/GRP2624/GRP2634/GRP2670/GRP2650 firmware contains third-party software licensed under the GNU General Public License (GPL). Grandstream uses software under the specific terms of the GPL. Please see the GNU General Public License (GPL) for the exact terms and conditions of the license.

Grandstream GNU GPL-related source code can be downloaded from the Grandstream website from:

[https://www.grandstream.com/hubfs/Product\\_Documentation/GRP261X/GRP2624/GRP2634\\_gnu\\_gpl.zip](https://www.grandstream.com/hubfs/Product_Documentation/GRP261X/GRP2624/GRP2634_gnu_gpl.zip)

---



## U.S. FCC Part 68 Regulatory Information

This equipment complies with Part 68 of the FCC rules. Located on the equipment is a label that contains, among other information, the ACTA registration number and ringer equivalence number (REN). If requested, this information must be provided to the telephone company.

The REN is used to determine the quantity of devices which may be connected to the telephone line. Excessive REN's on the telephone line may result in the devices not ringing in response to an incoming call. In most, but not all areas, the sum of the REN's should not exceed five (5.0). To be certain of the number of devices that may be connected to the line, as determined by the total REN's contact the telephone company to determine the maximum REN for the calling area.

This equipment cannot be used on the telephone company-provided coin service. Connection to Party Line Service is subject to State Tariffs. If this equipment causes harm to the telephone network, the telephone company will notify you in advance that temporary discontinuance of service may be required. If advance notice isn't practical, the telephone company will notify the customer as soon as possible. Also, you will be advised of your right to file a complaint with the FCC if you believe it is necessary.

The telephone company may make changes in its facilities, equipment, operations, or procedures that could affect the operation of the equipment. If this happens, the telephone company will provide advance notice in order for you to make the necessary modifications in order to maintain uninterrupted service.

If trouble is experienced with this equipment, please contact (Agent in the US):

**Company Name:** Grandstream Networks, Inc.

**Address:** 126 Brookline Ave, 3rd Floor Boston, MA 02215, USA

**Tel:** 1-617-5669300

**Fax:** 1-617-2491987

If the trouble is causing harm to the telephone network, the telephone company may request you to remove the equipment from the network until the problem is resolved.

This equipment uses the following USOC jacks: RJ45C.

It is recommended that the customer install an AC surge arrester in the AC outlet to which this device is connected. This is to avoid damaging the equipment caused by local lightning strikes and other electrical surges.

Since this device has the HAC function, the earpiece is easy to absorb small, please take care to avoid scratching.

## U.S. FCC Part 15 Regulatory Information

This device complies with part 15 of the FCC Rules. Operation is subject to the following two conditions: (1) This device may not cause harmful interference, and (2) this device must accept any interference received, including interference that may cause undesired operation.

Any Changes or modifications not expressly approved by the party responsible for compliance could void the user's authority to operate the equipment.

Note: This equipment has been tested and found to comply with the limits for a Class B digital device, pursuant to part 15 of the FCC Rules. These limits are designed to provide reasonable protection against harmful interference in a residential installation. This equipment generates, uses and can radiate radio frequency energy and, if not installed and used in accordance with the instructions, may cause harmful interference to radio communications. However, there is no guarantee that interference will not occur in a particular installation. If this equipment does cause harmful interference to radio or television reception, which can be determined by turning the equipment off and on, the user is encouraged to try to correct the interference by one or more of the following measures:

- Reorient or relocate the receiving antenna.
- Increase the separation between the equipment and receiver.
- Connect the equipment into an outlet on a circuit different from that to which the receiver is connected.
- Consult the dealer or an experienced radio/TV technician for help.

This equipment complies with FCC radiation exposure limits set forth for an uncontrolled environment. This equipment should be installed and operated with minimum distance 20cm between the radiator & your body. This transmitter must not be co-located or operating in conjunction with any other antenna or transmitter.

## Directive 2014/53/EU Regulatory Information

***This applies to GRP2612W/GRP2614/GRP2615/GRP2616 only***

Operating Frequency Band (RF)	Max Power	
2402-2480MHz (TX&RX)	BT-EDR	8.15dBm

2402-2480MHz (TX&RX)	BT-BLE	7.21dBm
2402-2480MHz (TX&RX)	802.11b	18.15dBm
	802.11g	18.42dBm
	802.11n-20	19.06dBm
2402-2480MHz (TX&RX)	802.11a	19.28dBm
	802.11n-20	18.78dBm
	802.11n-40	19.10dBm
	802.11ac20	18.89dBm
	802.11ac40	18.66dBm
	802.11ac80	15.80dBm
5250-5350MHz (TX&RX)	802.11a	18.63dBm
	802.11n-20	18.60dBm
	802.11n-40	18.93dBm
	802.11ac20	18.59dBm
	802.11ac40	18.38dBm
	802.11ac80	15.85dBm
5470-5725MHz (TX&RX)	802.11a	18.19dBm
	802.11n-20	18.32dBm
	802.11n-40	18.34dBm
	802.11ac20	18.44dBm
	802.11ac40	17.72dBm
	802.11ac80	15.45dBm

**Caution: Exposure to Radio Frequency Radiation**

This equipment complies with EU radiation exposure limits set forth for an uncontrolled environment. This equipment should be installed and operated with minimum distance of 20 cm between the radiator and your body.

**CE Authentication**



BE	BG	CZ	DK	DE	EE	IE	EL	LI
ES	FR	HR	IT	CY	LV	LT	LU	CH
HU	MT	NL	AT	PL	PT	RO	SI	TR
SK	FI	SE	NO	IS	UK	UK(NI)		

In the UK and EU member states, operation of 5150-5350 MHz is restricted to indoor use only.

Hereby, Grandstream Networks, Inc. declares that the radio equipment GRP2612W, GRP2614, GRP2615 and GRP2616 are in compliance with Directive 2014/53/EU.

The full text of the EU declaration of conformity is available at the following internet address:

<https://www.grandstream.com/support/resources/>

---

### **Copyright**

©2024 Grandstream Networks, Inc. <https://www.grandstream.com>

All rights reserved. Information in this document is subject to change without notice. Reproduction or transmittal of the entire or any part, in any form or by any means, electronic or print, for any purpose without the express written permission of Grandstream Networks, Inc. is not permitted.

Grandstream is a registered trademark and the Grandstream logo is the trademark of Grandstream Networks, Inc. in the United States, Europe and other countries.

---